

SenoClaire

Senographe Essential

Version ADS 56.10 Recon 01.10, 01.10.1

DICOM CONFORMANCE STATEMENT



5415902-2-8EN

Revision 1

© 2013 by General Electric Company All Rights Reserved.

This page is intentionally left blank.

Conformance Statement Overview

Table 1 on page 3 provides an overview of the network services supported by Senographe Essential.

Table 1 NETWORK SERVICES

SOP Classes	User of Service (SCU)	Provider of Service (SCP)
Transfer		
Digital Mammography X-Ray Image Storage – For Presentation	Yes	Yes
Digital Mammography X-Ray Image Storage – For Processing	Yes	Yes
Secondary Capture Image Storage	Yes	Yes
Breast Tomosynthesis Image Storage	Yes	No
Verification SOP Class	Yes	Yes
Query/Retrieve		
Study Root Query/Retrieve Information Model – FIND	Yes	No
Study Root Query/Retrieve Information Model – MOVE	Yes	No
Print Management		
Basic Grayscale Image Box SOP Class	Yes	No
Basic Grayscale Print Management Meta SOP Class	Yes	No
Presentation LUT SOP Class	Yes	No
Workflow Management		
Storage Commitment Push Model SOP Class	Yes	No
Modality Performed Procedure Step SOP Class	Yes	No
Modality Worklist Information Model – FIND SOP Class	Yes	No

Table 2 MEDIA SERVICES

Media Storage Application Profile	Write Files (FSC)	Read Files (FSR)
Compact Disk - Recordable		
General Purpose CD-R	Yes	Yes

This page is intentionally left blank.

Table of Contents

1. Introduction	7
1-1. Overview	7
1-2. Overall DICOM Conformance Statement Document Structure	8
1-3. Intended Audience	9
1-4. Field of Application	9
1-5. Important Remarks	9
1-6. References	10
1-7. Definitions	10
1-8. Symbols and Abbreviations	12
2. Network Conformance Statement	15
2-1. Introduction	15
2-2. Implementation Model	16
2-3. AE Specifications	24
2-4. Communication Profiles	46
2-5. Extension / Specializations / Privatization	46
2-6. Configuration	46
2-7. Support of Extended Character Sets	47
2-8. Security Profiles	47
3. Media Storage Conformance Statement	49
3-1. Introduction	49
3-2. Implementation Model	49
3-3. AE Specifications	51
3-4. Augmented and Private Application Profiles	54
3-5. Extensions, Specializations, Privatizations of SOP Classes and Transfer Syntaxes	54
3-6. Configuration	54
3-7. Support of Extended Character Sets	54
4. Digital Mammography X-ray Information Object Implementation	55
4-1. Introduction	55
4-2. MG IOD Implementation	55
4-3. MG Entity-Relationship Model	55
4-4. IOD Module Table	57
4-5. Information Module Definitions	59
4-6. Private Data Dictionary	81
4-7. Mammography View Codes	82
4-8. Limitations summary	83
5. Breast Tomosynthesis Image Information Object Implementation	85
5-1. Introduction	85
5-2. Breast Tomosynthesis IOD Implementation	85
5-3. Breast Tomosynthesis Entity-Relationship Model	85
5-4. IOD Module Table	87
5-5. Breast Tomosynthesis Image Functional Group Macros	88
5-6. Information Module Definitions	89
5-7. Private Data Dictionary	106
5-8. Limitations summary	106
6. SC Information Object Implementation	107

Table of Contents

6-1. Introduction	107
6-2. SC entity-relationship Model	107
6-3. Senographe Essential Acquisition workstation Mapping of DICOM entities	108
6-4. IOD Module table	109
6-5. SC-Information module definitions	109
7. Study Root Query/Retrieve - Information Model Definition	113
7-1. Introduction	113
7-2. Study Root Information Model Entity-Relationship Model	113
7-3. Information Model Keys	114
7-4. Private data dictionary	115
8. Modality Worklist Information Model Definition	117
8-1. Introduction	117
8-2. Modality Worklist Information Model Description	117
8-3. Modality Worklist Information Model Entity-Relationship Model	117
8-4. Information Model Module Table	119
8-5. Information Model Keys	120
8-6. Private data dictionary	128
9. Print Management Implementation	129
9-1. Introduction	129
9-2. Print management SOP class definitions	129
10. Storage commitment Push Model SOP Class Definition	137
10-1. Introduction	137
10-2. Storage Commitment Push Model SOP class definition	137
11. Modality Performed Procedure Step SOP Class Definition	141
11-1. Introduction	141
11-2. Modality Performed Procedure Step SOP class definition	141

1 Introduction

1-1 Overview

This DICOM Conformance Statement is divided into Sections as described below:

Section 1 *Introduction on page 7*, which describes the overall structure, intent, and references for this Conformance Statement

Section 2 *Network Conformance Statement on page 15*, which specifies the GEHC equipment compliance to the DICOM requirements for the implementation of Networking features.

Section 3 *Media Storage Conformance Statement on page 49*, which specifies the GEHC equipment compliance to the DICOM requirements for the implementation of Media Storage features.

Section 4 *Digital Mammography X-ray Information Object Implementation on page 55*, which specifies the GEHC equipment compliance to DICOM requirements for the implementation of a Digital Mammography X-ray Information Object Implementation feature.

Section 5 *Breast Tomosynthesis Image Information Object Implementation on page 85*, which specifies the GEHC equipment compliance to DICOM requirements for the implementation of Breast Tomosynthesis Image Information Object Implementation feature.

Section 6 *SC Information Object Implementation on page 107*, which specifies the use of the DICOM Secondary Capture Image IODs to represent the information included in SC Images displayed by this implementation.

Section 7 *Study Root Query/Retrieve - Information Model Definition on page 113*, which specifies the GEHC equipment compliance to DICOM requirements for the implementation of the Study Root Query/Retrieve Information Model feature.

Section 8 *Modality Worklist Information Model Definition on page 117*, which specifies the GEHC equipment compliance to DICOM requirements for the implementation of Basic Worklist Management Service feature.

Section 9 *Print Management Implementation on page 129*, which specifies the GEHC equipment compliance to DICOM requirements for the implementation of the Network Print Management SOP Class.

Section 10 *Storage commitment Push Model SOP Class Definition on page 137*, which specifies the GEHC equipment compliance to DICOM requirements for the implementation of the Storage Commitment Push service feature.

Section 11 *Modality Performed Procedure Step SOP Class Definition on page 141*, which specifies the GEHC equipment compliance to DICOM requirements for the implementation of the Modality Performed Procedure Step service feature.

1-2 Overall DICOM Conformance Statement Document Structure

The Documentation Structure of the GEHC Conformance Statements and their relationship with the DICOM Conformance Statements is shown in the Illustration below.

GEHC DICOM Conformance Statements

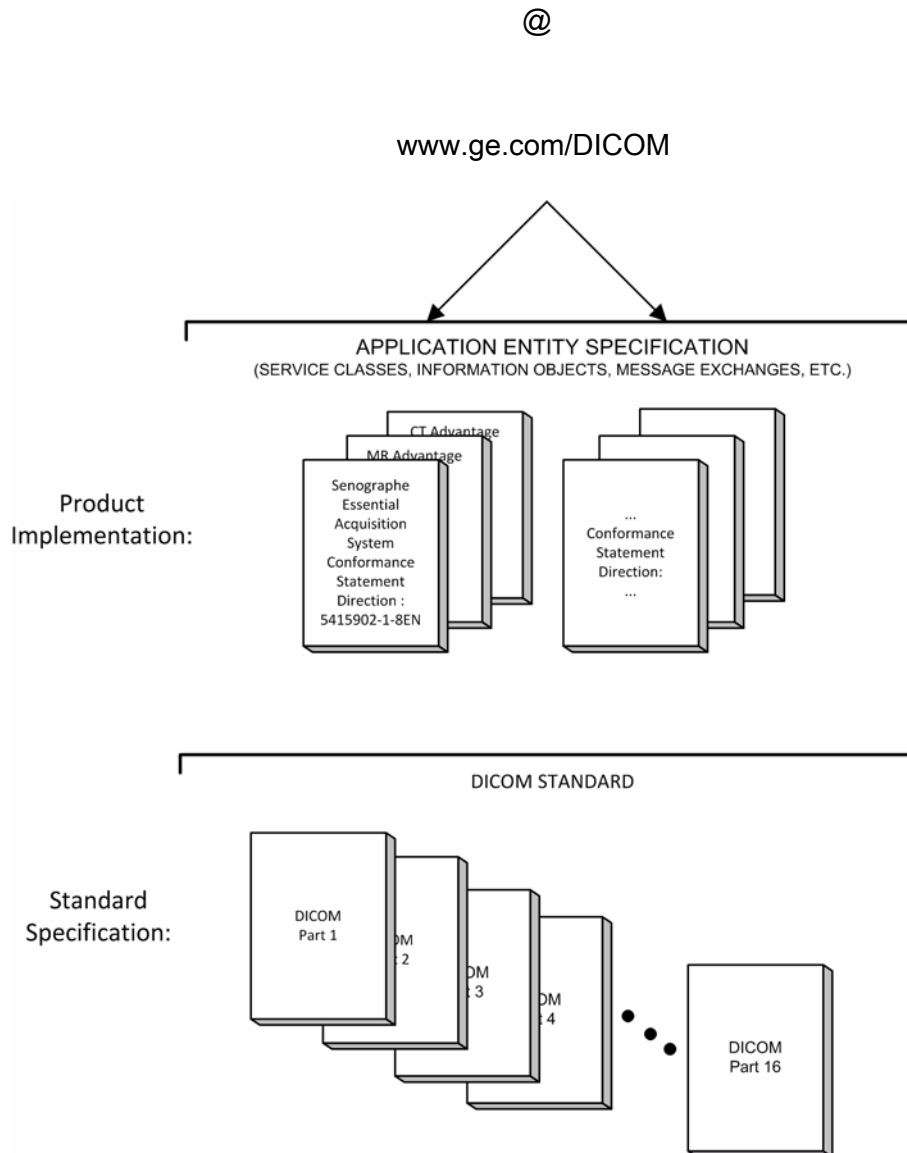

This document specifies the DICOM implementation. It is entitled:

Senographe Essential Acquisition Workstation
 Conformance Statement for DICOM
 Direction **5415902-2-8EN**

This DICOM Conformance Statement documents the DICOM Conformance Statement and Technical Specification required to interoperate with the GEHC network interface.

The GEHC Conformance Statement, contained in this document, also specifies the Lower Layer communications which it supports (e.g., TCP/IP). However, the Technical Specifications are defined in the DICOM Part 8 standard.

For more information regarding DICOM, copies of the Standard may be obtained on the Internet at <http://medical.nema.org>. Comments on the Standard may be addressed to:

DICOM Secretariat
NEMA
1300 N. 17th Street, Suite 1752
Rosslyn, VA 22209
USA
Phone: +1.703. 841.3200

1-3 Intended Audience

The reader of this document is concerned with software design and/or system integration issues. It is assumed that the reader of this document is familiar with the DICOM Standards and with the terminology and concepts which are used in those Standards.

1-4 Field of Application

It is the intent of this document to provide an unambiguous specification for GEHC implementations. This specification, called a Conformance Statement, includes a DICOM Conformance Statement and is necessary to ensure proper processing and interpretation of GEHC medical data exchanged using DICOM. The GEHC Conformance Statements are available to the public.

The reader of this DICOM Conformance Statement should be aware that different GEHC devices are capable of using different Information Object Definitions. For example, a GEHC CT Scanner may send images using the CT Information Object, MR Information Object, Secondary Capture Object, etc.

Included in this DICOM Conformance Statement are the Module Definitions which define all data elements used by this GEHC implementation. If the user encounters unspecified private data elements while parsing a GEHC Data Set, the user is well advised to ignore those data elements (per the DICOM standard). Unspecified private data element information is subject to change without notice. If, however, the device is acting as a "full fidelity storage device", it should retain and re-transmit all of the private data elements which are sent by GEHC devices.

1-5 Important Remarks

The use of these DICOM Conformance Statements, in conjunction with the DICOM Standards, is intended to facilitate communication with GE imaging equipment. However, **by itself, it is not sufficient to ensure that inter-operation will be successful**. The **user (or user's agent)** needs to proceed with caution and address at least four issues:

- **Integration** - The integration of any device into an overall system of interconnected devices goes beyond the scope of standards (DICOM), and of this introduction and associated DICOM Conformance Statements when interoperability with non-GE equipment is desired. The responsibility to analyze the applications requirements and to design a solution that integrates GE imaging equipment with non-GE systems is the **user's** responsibility and should not be underestimated. The **user** is strongly advised to ensure that such an integration analysis is correctly performed.

- **Validation** - Testing the complete range of possible interactions between any GE device and non-GE devices, before the connection is declared operational, should not be overlooked. Therefore, the **user** should ensure that any non-GE provider accepts full responsibility for all validation required for their connection with GE devices. This includes the accuracy of the image data once it has crossed the interface between the GE imaging equipment and the non-GE device and the stability of the image data for the intended applications.
Such a validation is required before any clinical use (diagnosis and/or treatment) is performed. It applies when images acquired on GE imaging equipment are processed/displayed on a non-GE device, as well as when images acquired on non-GE equipment is processed/displayed on a GE console or workstation.
- **Future Evolution** - GE understands that the DICOM Standard will evolve to meet the user's growing requirements. GE is actively involved in the development of the DICOM Standard. DICOM will incorporate new features and technologies and GE may follow the evolution of the Standard. The GEHC protocol is based on DICOM as specified in each DICOM Conformance Statement. Evolution of the Standard may require changes to devices which have implemented DICOM. **In addition, GE reserves the right to discontinue or make changes to the support of communications features (on its products) reflected on by these DICOM Conformance Statements.** The **user** should ensure that any non-GE provider, which connects with GE devices, also plans for the future evolution of the DICOM Standard. Failure to do so will likely result in the loss of function and/or connectivity as the DICOM Standard changes and GE Products are enhanced to support these changes.
- **Interaction** - It is the sole responsibility of the **non-GE provider** to ensure that communication with the interfaced equipment does not cause degradation of GE imaging equipment performance and/or function.

1-6 References

NEMA PS3 Digital Imaging and Communications in Medicine (DICOM) Standard, available free at <http://medical.nema.org/>.

1-7 Definitions

Informal definitions are provided for the following terms used in this Conformance Statement. The DICOM Standard is the authoritative source for formal definitions of these terms.

- **Abstract Syntax** – the information agreed to be exchanged between applications, generally equivalent to a Service/Object Pair (SOP) Class. Examples : Verification SOP Class, Modality Worklist Information Model Find SOP Class, Computed Radiography Image Storage SOP Class.
- **Application Entity (AE)** – an end point of a DICOM information exchange, including the DICOM network or media interface software; i.e., the software that sends or receives DICOM information objects or messages. A single device may have multiple Application Entities.
- **Application Entity Title** – the externally known name of an Application Entity, used to identify a DICOM application to other DICOM applications on the network.
- **Application Context** – the specification of the type of communication used between Application Entities. Example: DICOM network protocol.
- **Association** – a network communication channel set up between Application Entities.
- **Attribute** – a unit of information in an object definition; a data element identified by a tag. The information may be a complex data structure (Sequence), itself composed of lower level data elements. Examples: Patient ID (0010,0020), Accession Number (0008,0050), Photometric Interpretation (0028,0004), Procedure Code Sequence (0008,1032).
- **Information Object Definition (IOD)** – the specified set of Attributes that comprise a type of data object; does not represent a specific instance of the data object, but rather a class of similar data

objects that have the same properties. The Attributes may be specified as Mandatory (Type 1), Required but possibly unknown (Type 2), or Optional (Type 3), and there may be conditions associated with the use of an Attribute (Types 1C and 2C). Examples: MR Image IOD, CT Image IOD, Print Job IOD.

- Joint Photographic Experts Group (JPEG) – a set of standardized image compression techniques, available for use by DICOM applications.
- Media Application Profile – the specification of DICOM information objects and encoding exchanged on removable media (e.g., CDs)
- Module – a set of Attributes within an Information Object Definition that are logically related to each other. Example: Patient Module includes Patient Name, Patient ID, Patient Birth Date, and Patient Sex.
- Negotiation – first phase of Association establishment that allows Application Entities to agree on the types of data to be exchanged and how that data will be encoded.
- Planes –Breast Tomosynthesis Image defined by a series of parallel tomographic planes.
- Presentation Context – the set of DICOM network services used over an Association, as negotiated between Application Entities; includes Abstract Syntaxes and Transfer Syntaxes.
- Projection –Digital Mammography Image For Processing acquired during a 3D exam. Projections represent the source images used to reconstruct a 3D image: Breast Tomosynthesis Image.
- Protocol Data Unit (PDU) – a packet (piece) of a DICOM message sent across the network. Devices must specify the maximum size packet they can receive for DICOM messages.
- Security Profile – a set of mechanisms, such as encryption, user authentication, or digital signatures, used by an Application Entity to ensure confidentiality, integrity, and/or availability of exchanged DICOM data
- Service Class Provider (SCP) – role of an Application Entity that provides a DICOM network service; typically, a server that performs operations requested by another Application Entity (Service Class User). Examples: Picture Archiving and Communication System (image storage SCP, and image query/retrieve SCP), Radiology Information System (modality worklist SCP).
- Service Class User (SCU) – role of an Application Entity that uses a DICOM network service; typically, a client. Examples: imaging modality (image storage SCU, and modality worklist SCU), imaging workstation (image query/retrieve SCU)
- Service/Object Pair (SOP) Class – the specification of the network or media transfer (service) of a particular type of data (object); the fundamental unit of DICOM interoperability specification. Examples: Ultrasound Image Storage Service, Basic Grayscale Print Management.
- Service/Object Pair (SOP) Instance – an information object; a specific occurrence of information exchanged in a SOP Class. Examples: a specific x-ray image.
- Slabs – Breast Tomosynthesis Image defined by a series of slabs resulting from the combination of several planes.
- Tag – a 32-bit identifier for a data element, represented as a pair of four digit hexadecimal numbers, the “group” and the “element”. If the “group” number is odd, the tag is for a private (manufacturer-specific) data element. Examples: (0010,0020) [Patient ID], (07FE,0010) [Pixel Data], (0019,0210) [private data element]
- Transfer Syntax – the encoding used for exchange of DICOM information objects and messages. Examples: JPEG compressed (images), little endian explicit value representation.
- Unique Identifier (UID) – a globally unique “dotted decimal” string that identifies a specific object or a class of objects; an ISO-8824 Object Identifier. Examples: Study Instance UID, SOP Class UID, SOP Instance UID.

- Value Representation (VR) – the format type of an individual DICOM data element, such as text, an integer, a person’s name, or a code. DICOM information objects can be transmitted with either explicit identification of the type of each data element (Explicit VR), or without explicit identification (Implicit VR); with Implicit VR, the receiving application must use a DICOM data dictionary to look up the format of each data element.

1-8 Symbols and Abbreviations

AE	Application Entity
AET	Application Entity Title
CAD	Computer Aided Detection
CDA	Clinical Document Architecture
CD-R	Compact Disk Recordable
CSE	Customer Service Engineer
CR	Computed Radiography
DBT	Digital Breast Tomosynthesis
DHCP	Dynamic Host Configuration Protocol
DICOM	Digital Imaging and Communications in Medicine
DIT	Directory Information Tree (LDAP)
DN	Distinguished Name (LDAP)
DNS	Domain Name System
DX	Digital X-ray
FSC	File-Set Creator
FSU	File-Set Updater
FSR	File-Set Reader
GSDF	Grayscale Standard Display Function
GSPS	Grayscale Softcopy Presentation State
HIS	Hospital Information System
HL7	Health Level 7 Standard
IHE	Integrating the Healthcare Enterprise
IOD	Information Object Definition
IPv4	Internet Protocol version 4
IPv6	Internet Protocol version 6
ISO	International Organization for Standards
JPEG	Joint Photographic Experts Group
LDAP	Lightweight Directory Access Protocol
LDIF	LDAP Data Interchange Format
LUT	Look-up Table
MPEG	Moving Picture Experts Group
MG	Mammography (X-ray)
MPPS	Modality Performed Procedure Step
MSPS	Modality Scheduled Procedure Step
MTU	Maximum Transmission Unit (IP)
MWL	Modality Worklist
NTP	Network Time Protocol

O	Optional (Key Attribute)
OSI	Open Systems Interconnection
PACS	Picture Archiving and Communication System
PDU	Protocol Data Unit
R	Required (Key Attribute)
RDN	Relative Distinguished Name (LDAP)
RIS	Radiology Information System
RT	Radiotherapy
SC	Secondary Capture
SCP	Service Class Provider
SCU	Service Class User
SOP	Service-Object Pair
SPS	Scheduled Procedure Step
SR	Structured Reporting
TCP/IP	Transmission Control Protocol/Internet Protocol
U	Unique (Key Attribute)
UL	Upper Layer
VL	Visible Light
VR	Value Representation

This page is intentionally left blank.

2 Network Conformance Statement

2-1 Introduction

This section of the DICOM Conformance Statement specifies the compliance to DICOM conformance requirements for the relevant **Networking** features on this GEHC product. Note that the format of this section strictly follows the format defined in DICOM Standard PS 3.2 (Conformance). Please refer to that part of the standard while reading this section.

The details of the DICOM conformance related to other Information Objects and Information Models supported by this product are included in subsequent sections of this DICOM Conformance Statement.

Senographe Essential is an Integrated Digital X-Ray Mammography Imaging System:

- It uses DICOM services to export/import images to/from remote workstations.

- It uses DICOM Storage service to export 3D images to remote workstations.

- It uses DICOM Storage Commitment service to transfer ownership of images (including 3D images) to a remote workstation supporting storage commitment such as an archive system.

- It allows a user to query for and display DICOM modality worklist information from a remote hospital or radiology department information system computer. For example, a user may wish to query for all procedures scheduled to be performed on the system. In this situation, Senographe Essential Acquisition Workstation is providing the DICOM Modality Worklist SOP Class service as a service class user (SCU).

- It uses DICOM services to automatically broadcast the exam completion status, images (including 3D images) list, and overall glandular dose delivered, to a central repository, using the DICOM Modality Performed Procedure Step. In this situation, the Senographe Essential is providing the DICOM MPPS Service as a Service Class User (SCU).

- It uses the DICOM Print Management service class to send images (except 3D exam images) to hard copy printers.

Note:

Mammography system does not support importing 3D images from remote workstations or sending them to hard copy printers. Mammography system does not allow printing source images (i.e. Projections) acquired during 3D exams.

2-2 Implementation Model

2-2-1 Application Data Flow Diagram

The Basic and Specific Application models for this device are shown in the following Illustration:

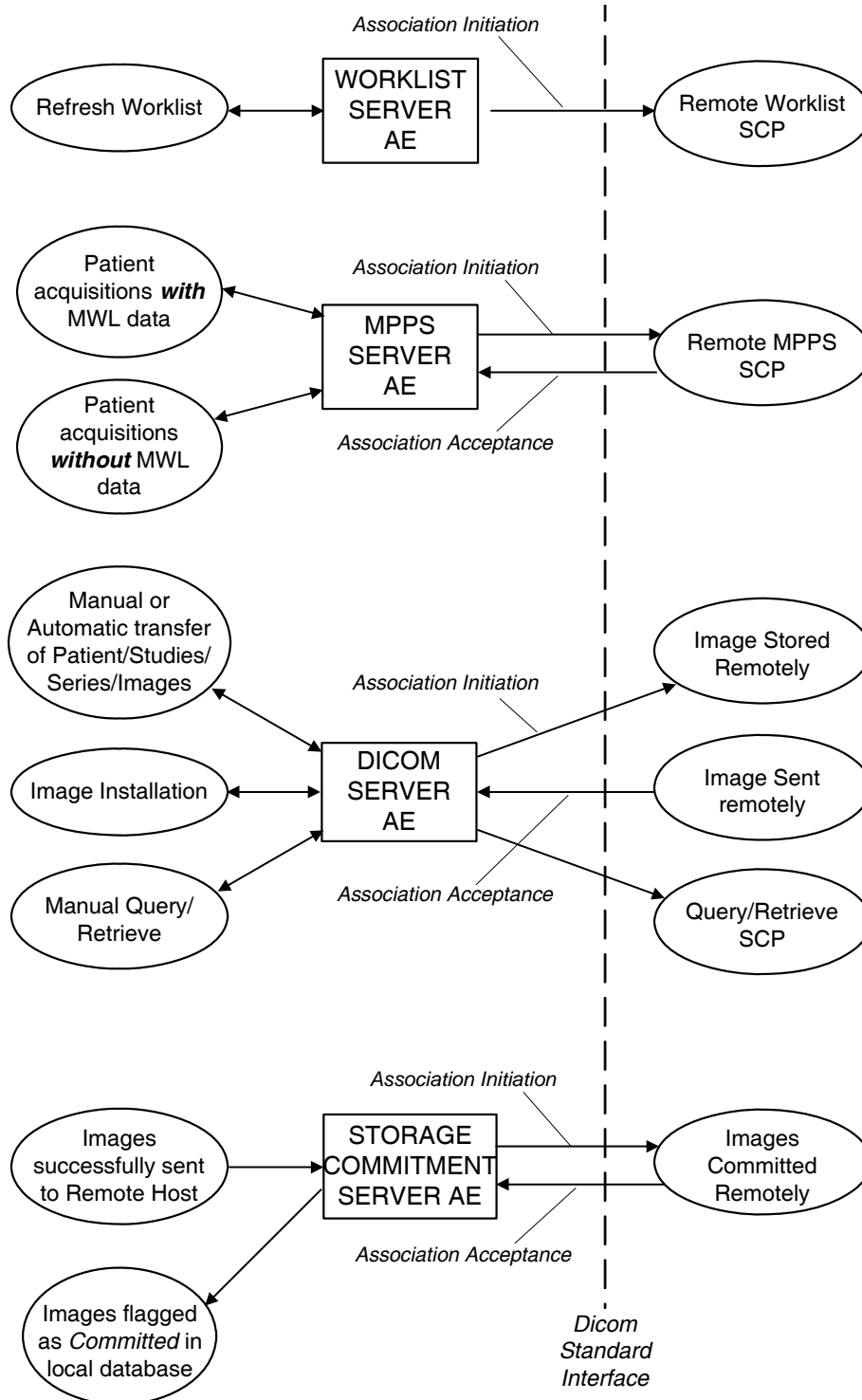

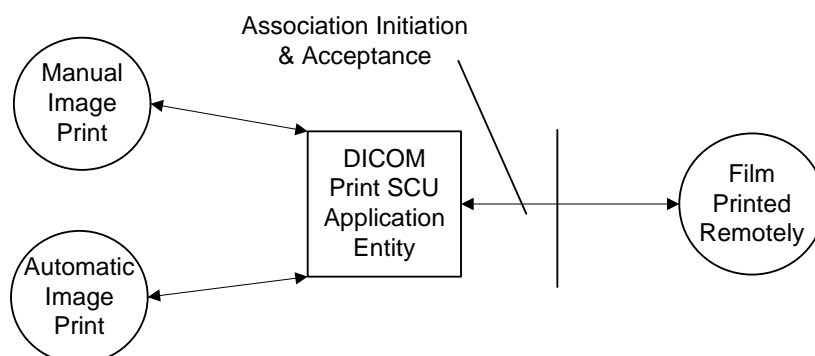
**Note:**

All AEs do support the verification SOP class as SCU. DICOM SERVER AE and STORAGE COMMITMENT SERVER AE also support the verification SOP class as SCP.

2-2-2 Functional Definition of AEs**DICOM SERVER AE:**

The DICOM SERVER Application Entity (AE) is an application which handles DICOM protocol communication. DICOM SERVER AE is automatically brought up when the Senographe Essential Acquisition Workstation is powered on.

The DICOM SERVER AE is invoked by the following Real World Activities:

- Manual Transfer of Patients/Studies/Series/Images (including 3D images) from the Senographe Essential Acquisition Workstation to a Remote Host.
For this operation, the operator selects patients, studies, series or images on the console browser and then sends the selected patients, studies, series or images on one or several remote DICOM AE by a drag and drop on the icon that represents the wanted remote DICOM AE.
All remote DICOM AE must be manually configured on the Senographe Essential Acquisition Workstation by an operator or by a field engineer.
The declaration of remote DICOM AE is done through the NETWORK MANAGEMENT option of the Browser toolkit menu.
- Automatic transfer of Images (including 3D images) from the Senographe Essential Acquisition Workstation to a Remote Host.
For this operation, the transfer of images is triggered automatically. When Auto-Push is ON, all images generated during an acquisition session, that verify Auto-Push settings, are automatically sent to the defined auto-push remote hosts when the user closes the exam.
The setting of Auto-Push status (ON/OFF) and Auto-Push remote host is done through the MEDICAL APPLICATION PREFERENCES option of the Browser toolkit menu.
The visualization of the transfer status is done on a specific message window.
- Images (except 3D images) Sent Remotely from a Remote DICOM AE to the Senographe Essential Acquisition Workstation.
When images are installed in the local database, they are displayed in the Senographe Essential Acquisition Workstation browser.
- Manual Query/Retrieve
For this operation, the operator queries a remote database to obtain a list of data at Patient/Study/Series/Image by clicking on the icon that represents the wanted remote DICOM AE. Once the remote

browser is displayed, the operator can retrieve images of the SOP Classes supported by the Senographe Essential Acquisition Workstation from the remote DICOM AE.

The query is selective based on criteria described below in the document.

Note:

Retrieval of Breast Tomosynthesis Image storage SOP Class is not supported.

The DICOM SERVER AE initiates the following operations:

- Access to patient demographics and pixel data in the local database.
- Build a DICOM format data set.
- Initiate a DICOM association to send DICOM SOP Classes to a remote DICOM AE.
- Initiate a DICOM association to ask for remote patient demographics.
- Initiate a DICOM association to ask for transmit images from a remote DICOM AE to Senographe Essential Acquisition Workstation.

The DICOM SERVER AE waits for association requests from Remote AE:

- Answer to DICOM associations transmitting DICOM SOP Classes to be stored on the Senographe Essential Acquisition Workstation.
- Answer to DICOM associations transmitting Verification SOP Class to the Senographe Essential Acquisition Workstation.

WORKLIST SERVER AE:

The WORKLIST SERVER AE is automatically brought up when the Senographe Essential Acquisition Workstation is powered on.

All remote Worklist SCPs must be manually configured on the Senographe Essential Acquisition Workstation by a field engineer. The configuration of remote Worklist SCP is done through the option Worklist Management of the Browser Toolkit Menu.

The WORKLIST SERVER AE is invoked by the real world activity: Refresh Worklist.

For this operation, the user clicks on the REFRESH WORKLIST button of the Worklist screen in order to obtain latest modality worklist from the RIS. The WORKLIST SERVER sends a query defined by the user to remote AEs and returns the results to the user interface.

The WORKLIST SERVER AE initiates the following functions:

- Build the Worklist query according to the criteria defined by the user in the Query Definition Window.
- Send the query to Worklist Provider: Initiates a DICOM association with the Worklist Provider. If the remote Worklist Provider accepts a presentation context applicable to modality worklist, the WORKLIST SERVER AE issues a modality worklist query request via the C-FIND service.

STORAGE COMMITMENT SERVER AE:

The STORAGE COMMITMENT SERVER AE is automatically brought up when the Senographe Essential Acquisition Workstation is powered on.

The STORAGE COMMITMENT SERVER AE is invoked by the Real World Activities: Images (including 3D images) successfully sent to a remote host supporting Storage Commitment.

The declaration of remote host supporting Storage Commitment is done through a specific menu (known as NETWORK MANAGEMENT menu).

When STORAGE COMMITMENT SERVER AE receives a successful commitment for some images, it flags them as Committed in the local database.

The STORAGE COMMITMENT SERVER AE initiates the following operations:

- Initiate a DICOM association to ask a remote host (Storage Commitment SCP) storage commitment on specific images.

The STORAGE COMMITMENT SERVER AE waits for association requests from Remote Storage Commitment AE:

- Answer to DICOM associations transmitting Storage Commitment Notification (N-EVENT-REPORT)

MPPS SERVER AE:

The MPPS SERVER AE is automatically brought up when the Senographe Essential Acquisition Workstation is powered on.

All remote MPPS SCPs must be manually configured on the Senographe Essential Acquisition Workstation by a field engineer. The configuration of remote MPPS SCP is done through the option PPS Management of the Browser Toolkit menu.

The MPPS SERVER AE is invoked by the following real world activity: acquire images.

The MPPS SERVER AE is implemented as an application process on the Senographe Essential Acquisition Workstation. It runs as a daemon serving requests from other applications to send the PPS information to the remote AE and return the results to the requesting application.

The MPPS SERVER AE initiates the following functions.

- Start PPS: Initiates a DICOM association in order to create a DICOM Modality Performed Procedure Step SOP instance in the remote AE. If the remote MPPS SCP accepts a presentation context applicable to Modality performed Procedure Step, the MPPS SERVER AE will issue a request to create the SOP instance in the remote MPPS SCP via the N-CREATE service.
- Complete PPS: Initiates a DICOM association in order to update a DICOM Modality Performed Step instance that is already created with the remote MPPS SCP. If the remote MPPS SCP accepts a presentation context applicable to Modality performed Procedure Step, the MPPS SERVER AE will issue a request to update the SOP instance in the remote MPPS SCP via the N-SET service. The PPS Status is set to 'COMPLETED'.
- Append PPS: Initiates a DICOM association in order to append a DICOM Modality Performed Procedure Step SOP instance that is already created with the remote MPPS SCP. If the remote MPPS SCP accepts a presentation context applicable to Modality performed Procedure Step, the MPPS SERVER AE will issue a request to send the append SOP instance in the remote MPPS SCP via the N-CREATE service.
- Discontinue PPS: Initiates a DICOM association in order to update a DICOM Modality Performed Step instance that is already created with the remote MPPS SCP. If the remote MPPS SCP accepts a presentation context applicable to Modality performed Procedure Step, the PPS SERVER AE will issue a request to update the SOP instance in the remote MPPS SCP via the N-SET service. The PPS Status is set to 'DISCONTINUED'.

PRINT SERVER AE:

The DICOM Print SCU Application Entity (AE) is an application which handles DICOM protocol communication with Remote DICOM Printers. The DICOM Print SCU AE is activated when the user requests for a print or when automatic print is triggered at close exam time.

The DICOM Print SCU AE does not support printing source images acquired during 3D exam (i.e. Projections) nor 3D Images.

The DICOM Print SCU AE is invoked by the following Real World Activity:

- Manual Image Print.

For this operation, the operator selects an image in the VIEWER, then prints the image clicking on the PRINT button.

- Automatic Image Print

For this operation, user set Auto-Print ON. Then when he acquires images, images are automatically printed at Close Exam time.

In manual or automatic print, the PRINT MANAGER receives the Simple print request, composes a film then send the film to the selected Remote DICOM Printer.

The DICOM Print SCU AE supports the following functions:

- Access to pixel data in the local database.
- Initiate a DICOM association to send DICOM SOP Classes (corresponding to the DICOM Print Management service class) to a remote DICOM Printer.

2-2-3 Sequencing of Real-World Activities

DICOM SERVER AE:

In case of automatic transfer of images (including 3D images) to a remote host:

1. User set Auto-Push ON and defines auto-push remote hosts.
2. User starts an exam.
3. User acquires images
4. User clicks on CLOSE EXAM
5. Images are sent to auto-push remote hosts.

WORKLIST SERVER AE:

The user will usually refresh the Worklist before the image acquisition in order to get the very latest information from the RIS.

1. Upon user request, the system initiates a modality worklist query (as a modality worklist SCU) to the modality worklist SCP with a given set of query parameters.
2. The modality worklist SCP returns responses which match the query parameters.
3. Items from the returned worklist responses are filtered according to the query parameters
4. Only the items matching the query parameters are presented to the user.
5. Each item of the returned worklist responses selected for image acquisition is included in acquired DICOM images related to the responses. Only one item can be selected to perform an acquisition.

STORAGE COMMITMENT SERVER AE:

1. The user selects the images (including 3D images) and send them to a remote host.
2. If the remote host was declared on the system along with an associated Storage Commitment Provider (remote host and storage commitment provider may have different configurations) and if the images are successfully sent, then N-ACTION-RQ request is sent to Storage Commitment Provider
3. Waits for N-ACTION-RSP from Storage Commitment Provider
4. On reception of failure in N-ACTION-RSP, Storage Commitment AE logs the error, displays a pop-up and stops.
5. On reception of success, Storage Commitment AE is ready to receive at any time from Storage Commitment Provider the N-EVENT-REPORT-RQ notification on a new association.
6. On reception of N-EVENT-REPORT-RQ notification from Storage Commitment Provider, system flags the images in the database as committed.
7. When all images are flagged, Storage Commitment AE sends a N-EVENT-REPORT-RSP to the Storage Commitment Provider

MODALITY PERFORMED PROCEDURE STEP SERVER AE:

The Modality performed procedure step messages are automatically exchanged with the remote MPPS SCP provided the following pre-conditions are met:

- The remote MPPS SCP is properly declared on the Senographe Essential and has been associated to one remote host (ex: an image archiving system (PACS)).

- The autopush feature is activated to automatically transfer images to the remote host used in the MPPS configuration. Also note that the following rules apply for the MPPS messages to be sent:
 - Any generated image SOP instances (either FOR PROCESSING, FOR PRESENTATION or both, or Breast Tomosynthesis Image) but at least one type are sent to the MPPS-linked PACS,
 - At least the generated FOR PROCESSING image SOP instances are sent to the MPPS-linked CAD.

Note:

The FOR PROCESSING, FOR PRESENTATION and Breast Tomosynthesis Image types used in the above rule refer respectively to the standard SOP classes described in section 2-3-1.

Moreover three real-world activity cases can be described:

1. PPS acquisitions with Modality Worklist data
2. PPS acquisitions without Modality Worklist data
3. Acquisitions with PPS preconditions not met.

PPS acquisitions with Modality Worklist data

If the Senographe Essential is connected to a Remote worklist SCP, worklist information can be obtained from the HIS/RIS system through the basic worklist management service. The use of this information to create image SOP instances and MPPS SOP instances is described later in this document.

Once a worklist entry is selected to open the medical application in acquisition mode, the system retrieves necessary information from the WORKLIST SERVER AE as mapped in section 11 Table 1 on page 141.

- The system initiates a “start MPPS” when the first image of the series has been acquired. The MPPS SERVER AE initiates one MPPS N-CREATE request to the remote MPPS SCP, in order to create an MPPS SOP instance with an “IN PROGRESS” status.
- The remote MPPS SCP returns response indicating the success/failure of the request execution. The Senographe Essential does not inform the user of the request execution status. In case of a failure, the system retries according to the user-defined retry options. Once the maximum number of retries is reached the Senographe Essential abandons this MPPS SOP instance. The corresponding error codes can be found in the local MPPS logfiles stored on the system.
- At examination closure and if the remote MPPS SCP successfully processed the N-CREATE request, the Senographe Essential initiates a N-SET message to update the already created MPPS SOP instance corresponding to this examination. Based on the operator’s choice within the application exit popup, two exit status can be sent. By default, the N-SET request sent to the remote MPPS SCP conveys a “COMPLETED” status. If the user decides it from the interface provided, the N-SET request can also convey a “DISCONTINUED” status.
- The remote MPPS SCP returns response indicating the success/failure of the request execution. The Senographe Essential does not inform the user of the request execution status. In case of failure, the system again retries according to user-defined retry options. Once the maximum number of retries is reached the Senographe Essential abandons this MPPS SOP Instance. The corresponding error codes can be found in the local MPPS logfiles stored on the system.

The following additional steps only occur in the case of a 3D exam, to reference the 3D Images, at examination closure and if the remote MPPS SCP successfully processed the N_SET request:

- The system initiates an "append MPPS" when the 3D Image reconstruction is complete. The MPPS SERVER AE initiates one MPPS N-CREATE request to the remote MPPS SCP, in order to create an SOP instance with "IN PROGRESS" status.

- The remote MPPS SCP returns response indicating the success/failure of the request execution. The Senographe Essential does not inform the user of the request execution status. In case of a failure, the system retries according to the user-defined retry options. Once the maximum number of retries is reached the Senographe Essential abandons this MPPS SOP instance. The corresponding error codes can be found in the local MPPS logfiles stored on the system.
- If the remote MPPS SCP successfully processed the N-CREATE request sent in the previous step, the Senographe Essential initiates a N-SET message to update the already created MPPS SOP instance corresponding to this examination. Based on the operator's choice within the application exit popup, two Performed Procedure Step Status values can be sent. By default, the N-SET request sent to the remote MPPS SCP conveys a "COMPLETED" status. As per user choice when closing the exam, the N-SET request can also convey a "DISCONTINUED" status.

PPS acquisitions without Modality Worklist data

If the Senographe Essential is not connected to a remote worklist SCP or if an acquisition is started using patient data entered on the local interface, an entry is still created on the local worklist.

- Once a worklist entry is selected to open the medical application in acquisition mode, the system retrieves necessary information from the local worklist as mapped in section 11 Table 1 on page 141.
- From this point on the sequencing of events is equivalent to the real-world activities for PPS acquisitions *with* Modality worklist data described in the previous section.

Acquisitions with PPS preconditions not met.

If the Senographe Essential does not have an MPPS Server AE connection available or if the preconditions described above are not met, no MPPS SOP instance is created.

- No 'Start PPS' event occurs when the first images has been acquired for a given examination
- No information relative to the Performed Procedure Step and/or any MPPS SOP instance is put in the resulting Image SOP instance

PRINT SERVER AE:

Manual Image Print:

1. The user selects the remote DICOM Printer from the Print Manager GUI.
2. The user selects an image in the VIEWER, then prints the image using the Simple print function.
3. The PRINT MANAGER receives the Simple print request, composes a film then activates the DICOM Print SCU AE that initiate the following actions.
4. Initiates a DICOM association and selects a Presentation Context
5. N-GETs printer status from the Printer SOP Instance
 - If Printer Status is FAILURE
 - Signal print failure to the user
 - Association is aborted
 - Else If Printer Status is WARNING and Printer Status Info is not equal to SUPPLY LOW or SUPPLY EMPTY
 - Signal print warning to the user
 - Association is released
6. N-CREATEs a Presentation LUT SOP instance if a review room is declared.
7. N-CREATEs a Basic Film Session SOP Instance
8. N-CREATEs a Basic Film Box SOP Instance for the current film

9. N-SETs the Basic Film Box SOP Instance with the Image Box SOP Instance for each image on the film
10. N-ACTIONS on the Basic Film Box SOP Instance
11. N-DELETES on the Basic Film Box SOP Instance
If DICOM_PRINT_WAIT_SCP_EVENT environment variable is set
12. Wait for N-EVENT-REPORTs of the Printer SOP Instance indicating printer status
13. If no N-EVENT-REPORT has been received after a configurable time out performs an NGET to obtain the printer status from the Printer SOP Instance
(The time out value is defined in the file ~sdcc/app-defaults/dicom_print/dprint.cfg)
14. Releases the DICOM association after printing is successful or failure has been signaled to the user

Automatic Image Print is same as Manual Print except that step 1 and 2 are to be replaced by:

1. User sets Auto-Print ON and defines auto-print parameters.
2. User starts an exam, acquires images and clicks on CLOSE EXAM.

Manual and Automatic Image Print does not support images created during 3D exam (i.e. projections and 3D images).

2-3 AE Specifications

2-3-1 DICOM SERVER AE Specification

This Application Entity provides Standard Conformance to the following DICOM SOP Classes as a **SCU**

SOP Class Name	SOP Class UID
Digital Mammography X-Ray Image Storage - For Presentation	1.2.840.10008.5.1.4.1.1.1.2
Digital Mammography X-Ray Image Storage - For Processing	1.2.840.10008.5.1.4.1.1.1.2.1
Breast Tomosynthesis Image Storage	1.2.840.10008.5.1.4.1.1.13.1.3
Secondary Capture Image Storage	1.2.840.10008.5.1.4.1.1.7
Study Root Query/Retrieve Information Model - FIND	1.2.840.10008.5.1.4.1.2.2.1
Study Root Query/Retrieve Information Model - MOVE	1.2.840.10008.5.1.4.1.2.2.2
Verification SOP Class	1.2.840.10008.1.1

1. C-FIND is done using Study Root Information Model.
2. C-MOVE is done using Study Root Information Model.

This Application Entity provides Standard Conformance to the following DICOM SOP Classes as an **SCP**:

SOP Class Name	SOP Class UID
Digital Mammography X-Ray Image Storage - For Presentation	1.2.840.10008.5.1.4.1.1.1.2
Digital Mammography X-Ray Image Storage - For Processing	1.2.840.10008.5.1.4.1.1.1.2.1
Secondary Capture Image Storage	1.2.840.10008.5.1.4.1.1.7
Verification SOP Class	1.2.840.10008.1.1

2-3-1-1 Association Establishment Policies

2-3-1-1-1. General

The DICOM Application Context Name (ACN), which is always proposed, is:

Application Context Name	1.2.840.10008.3.1.1.1

The Maximum Length PDU negotiation is included in all association establishment requests.

The maximum length PDU for an association initiated by the DICOM SERVER AE is:

Maximum Length PDU	28Kbytes

The SOP Class Extended Negotiation is not supported.

The maximum number of Presentation Context Items that will be proposed is 18.

The user information Items sent by this product are:

- Maximum PDU Length
- Implementation UID

2-3-1-1-2. Number of Associations

The DICOM SERVER AE will initiate only one DICOM association at a time to perform a DICOM store operation as a SCU to a Remote Host AE.

The DICOM SERVER AE can have a maximum of 4 open DICOM associations at a time to perform a DICOM store operation as a SCP or respond to an echo.

The DICOM SERVER AE will initiate only one DICOM association at a time to perform a Query/Retrieve with a Remote Host AE.

2-3-1-1-3. Asynchronous Nature

Asynchronous mode is not supported. All operations will be performed synchronously.

2-3-1-1-4. Implementation Identifying Information

The Implementation UID for this DICOM Implementation is:

Senographe Essential Acquisition Workstation Implementation UID	Depending on the hardware revision of Acquisition Workstation: - V1/V2 (SUN BLADE 150): 1.2.840.113619.6.254 - V3 (U20)/V4 (Z400): 1.2.840.113619.6.255 For Digital Breast Tomosynthesis Images: - 1.2.840.113619.6.324
--	---

2-3-1-1-5. Association Initiation by Real-World Activity

2-3-1-1-5-1. Real-World Activity: Manual Transfer of Patients/Studies/Series/Images

2-3-1-1-5-1-1. Associated Real-World Activity

The operator does the following:

- Select in the BROWSER one or several Patient Folders (or Studies/Series/Images) to be sent. Then, either drag and drop the selection on the icon representing then Remote DICOM AE, or click on the Push icon and select a Remote DICOM AE in the LIST OF REMOTE HOSTS.

Note:

In the case of a 3D exam, acquired source image (i.e. projection) cannot be sent to a remote host as a stand alone image. Projections can be sent at Patient/Studies/Series levels only.

This operation causes:

- The Senographe Essential Acquisition Workstation to retrieve the selected images from its local database.
- The DICOM SERVER AE to initiate a DICOM association, negotiate with the Remote AE an appropriate Abstract and Transfer Syntax.
- The emission of a C-STORE command to send the images, if the negotiation is successful.

2-3-1-1-5-1-2. Proposed Presentation Context Table

Table 1 Proposed Presentation Context Table

Abstract Syntax		Transfer Syntax		Role	Extended Negotiation
Name	UID	Name List	UID List		
Digital Mammography X-Ray Image Storage - For Presentation	1.2.840.10008.5.1.4.1.1.1.2	Explicit VR Big Endian	1.2.840.10008.1.2.2	None	None
Digital Mammography X-Ray Image Storage - For Presentation	1.2.840.10008.5.1.4.1.1.1.2	Implicit VR Little Endian	1.2.840.10008.1.2	None	None
Digital Mammography X-Ray Image Storage - For Presentation	1.2.840.10008.5.1.4.1.1.1.2	Explicit VR Little Endian	1.2.840.10008.1.2.1	None	None
Digital Mammography X-Ray Image Storage - For Processing	1.2.840.10008.5.1.4.1.1.1.2.1	Explicit VR Big Endian	1.2.840.10008.1.2.2	None	None
Digital Mammography X-Ray Image Storage - For Processing	1.2.840.10008.5.1.4.1.1.1.2.1	Implicit VR Little Endian	1.2.840.10008.1.2	None	None
Digital Mammography X-Ray Image Storage - For Processing	1.2.840.10008.5.1.4.1.1.1.2.1	Explicit VR Little Endian	1.2.840.10008.1.2.1	None	None
Breast Tomosynthesis Image Storage	1.2.840.10008.5.1.4.1.1.13.1.3	Explicit VR Big Endian	1.2.840.10008.1.2.2	None	None
Breast Tomosynthesis Image Storage	1.2.840.10008.5.1.4.1.1.13.1.3	Implicit VR Little Endian	1.2.840.10008.1.2	None	None
Breast Tomosynthesis Image Storage	1.2.840.10008.5.1.4.1.1.13.1.3	Explicit VR Little Endian	1.2.840.10008.1.2.1	None	None
Breast Tomosynthesis Image Storage	1.2.840.10008.5.1.4.1.1.13.1.3	Lossless JPEG Compression	1.2.840.10008.1.2.4.70	None	None
Breast Tomosynthesis Image Storage	1.2.840.10008.5.1.4.1.1.13.1.3	Lossy JPEG Compression	1.2.840.10008.1.2.4.51	None	None
Secondary Capture Image Storage	1.2.840.10008.5.1.4.1.1.7	Explicit VR Big Endian	1.2.840.10008.1.2.2	None	None
Secondary Capture Image Storage	1.2.840.10008.5.1.4.1.1.7	Implicit VR Little Endian	1.2.840.10008.1.2	None	None
Secondary Capture Image Storage	1.2.840.10008.5.1.4.1.1.7	Explicit VR Little Endian	1.2.840.10008.1.2.1	None	None

Note:

Other presentation contexts not documented in this table may be proposed (e.g. Digital X-ray Image Storage/ Explicit VR Big Endian)

Note:

The DICOM Server AE can be configured to dismiss Lossy Jpeg Compression transfer syntax for Breast Tomosynthesis Image Storage SOP Class.

2-3-1-1-5-1-2-1. Common SOP Specific DICOM Conformance Statement for all Storage SOP Classes

The following table gives the status codes that are more specifically processed when receiving responses from a **Storage SCP** equipment

Table 2 Status Codes Processed when receiving from Storage SCP Equipment:

Service Status	Status Codes	Further Meaning	Application behavior when receiving Status Codes	Related Fields Processed if received
Refused	A7xx	Out of resources	Association is closed with Remote AE. A message is displayed to the user. Error is logged. Retry is done until 3 times.	(0000,0902)
	0122	SOP Class not Supported	Association is closed with Remote AE. A message is displayed to the user. Error is logged.	(0000,0902)
Error	Cxxx	Cannot Understand	Association is closed with Remote AE. A message is displayed to the user. Error is logged.	(0000,0901) (0000,0902)
	A9xx	Data Set does not match SOP Class	Association is closed with Remote AE. A message is displayed to the user. Error is logged.	(0000,0901) (0000,0902)
Warning	B000	Coercion of Data Elements	Association is closed with Remote AE. A message is displayed to the user. Error is logged.	(0000,0901) (0000,0902)
	B007	Data Set does not match SOP Class	Association is closed with Remote AE. A message is displayed to the user. Error is logged.	(0000,0901) (0000,0902)
	B006	Elements Discarded	Association is closed with Remote AE. A message is displayed to the user. Error is logged.	(0000,0901) (0000,0902)
Success	0000			None

2-3-1-1-5-2. Real-world activity: Automatic Transfer of Patients/Studies/Series/Images

2-3-1-1-5-2-1. Associated Real-World Activity

The operator does the following:

Set Auto-Push ON and Auto-Push remote hosts.

Start an exam, acquire images and close the exam.

This operation will cause:

- The DICOM SERVER AE to initiate a DICOM association, negotiate with the Remote AE an appropriate Abstract and Transfer Syntax.
- To emit C-STORE command to send the acquired images, if the negotiation is successful.

2-3-1-1-5-2-2. Proposed Presentation Context Table

Same as in the Real World Activity Manual Transfer of Patients/Studies/Series/Images.

2-3-1-1-5-2-2-1. Common SOP Specific DICOM Conformance Statement for all Storage SOP Classes

Same as in the Real World Activity Manual Transfer of Patients/Studies/Series/Images.

2-3-1-1-5-3. Real-World Activity: Manual Query/Retrieve

2-3-1-1-5-3-1. Associated Real-World Activity

The operator queries a Remote database by clicking on the icon representing the DICOM Remote AE. A new BROWSER (known as the REMOTE BROWSER) appears on the screen(s) upon successful query. Then, the operator can select one or several Patient Folders/Studies/Series/Images and can either drag on drop the selection on the icon representing the Senographe Essential Acquisition Workstation or click on the Pull icon to retrieve the selection on the Senographe Essential Acquisition Workstation database. These operation will cause:

- the DICOM SERVER AE to initiate a DICOM association.
- the DICOM SERVER AE to emit a C-FIND request to get a list of patients regarding the criteria listed below, then to get the selected studies, series or images.
- the DICOM SERVER AE to emit a C-MOVE request to specify a selected list of Patient Folders/ Studies/Series/Images to be sent by the Remote Host to the Senographe Essential Acquisition Workstation.

2-3-1-1-5-3-2. Proposed Presentation Context Table

Table 3 Proposed Presentation Context Table

Abstract Syntax		Transfer Syntax		Role	Extended Negotiation
Name	UID	Name List	UID List		
Study Root Query/ Retrieve Information Model - FIND	1.2.840.10008.5.1.4.1.2 .2.1	Implicit VR Little Endian	1.2.840.10008.1.2	SCU	None
Study Root Query/ Retrieve Information Model - MOVE	1.2.840.10008.5.1.4.1.2 .2.2	Implicit VR Little Endian	1.2.840.10008.1.2	SCU	None

2-3-1-1-5-3-2-1. SOP Specific DICOM Conformance Statement for the Model, Study Root Query/ Retrieve Information Model -FIND SOP Class

Following are the status codes that are more specifically processed when receiving messages from a **Query** SCP equipment

Table 4 Status Codes Processed when receiving from Query SCP Equipment:

Service Status	Status Codes	Further Meaning	Application behavior when receiving Status Codes	Related fields processed if received
Refused	A7xx	Out of resources	Association is closed. Appropriate message is displayed to the user.	(0000,0902)
	0122	SOP Class not Supported	Association is closed. Appropriate message is displayed to the user.	(0000,0902)

Service Status	Status Codes	Further Meaning	Application behavior when receiving Status Codes	Related fields processed if received
Failed	A9xx	Identifier does not match SOP Class	Association is closed. Error message is displayed to the user.	(0000,0901) (0000,0902)
	Cxxx	Unable to process	Association is closed. Error message is displayed to the user.	(0000,0901) (0000,0902)
Cancel	FE00	Matching terminated due to cancel	Association is closed. Error message is displayed to the user.	None
Success	0000	Matching is complete - No final identifier is supplied		None
Pending	FF00	Matches are continuing - Current Match is supplied and any Optional Keys were supported in the same manner as Required Keys.		Identifier
	FF01	Matches are continuing - Warning that one or more Optional Keys were not supported for existence and/or matching for this Identifier		Identifier

Note:

C-CANCEL is not supported

Status code *Cancel* is considered as an error; it should never be received because the user cannot request a cancel.

Any other status received either during the C-FIND or C-MOVE associations will trigger a generic communication error.

The C-FIND SCU will only perform hierarchical queries (no extended negotiation supported).

Each C-FIND SCU supports an Association Timer, Operation Timer, Session Timer that can be configured at installation time. These timers default to 60, 90, 3600 seconds.

The DICOM SERVER AE will parse each matching C-FIND-RSP reply and will abort the association if an entry does not contain a valid dataset.

2-3-1-1-5-4. Real-World Activity: Verification

2-3-1-1-5-4-1. Associated Real-World Activity

Verification SCU service is not accessible through user interface. The User must run the sendecho command from a command window.

This operation will trigger:

- the DICOM SERVER AE to initiate a DICOM association.
- the DICOM SERVER AE to emit a C-ECHO

2-3-1-1-5-4-2. Proposed Presentation Context Table

2-3-1-1-5-4-2-1. Proposed Presentation Context Table

Abstract Syntax		Transfer Syntax		Role	Extended Negotiation
Name	UID	Name List	UID List		
Verification SOP Class	1.2.840.10008.1.1	Implicit VR Little Endian	1.2.840.10008.1.2	SCU	None
Verification SOP Class	1.2.840.10008.1.1	Explicit VR Little Endian	1.2.840.10008.1.2.1	SCU	None
Verification SOP Class	1.2.840.10008.1.1	Explicit VR Big Endian	1.2.840.10008.1.2.2	SCU	None

2-3-1-1-5-4-2-2. SOP Specific DICOM Conformance Statement for the Verification SOP Class

Following are the status codes that are more specifically processed when receiving messages from a Verification SCP equipment

Table 5 Status Codes Processed when receiving from Query SCP Equipment:

Service Status	Status Codes	Further Meaning	Application behavior when receiving Status Codes	Related fields processed if received
Success	0000			None

2-3-1-1-6. Association Acceptance Policy

When the DICOM SERVER AE accepts an association, it will receive any images transmitted on that association and store the supported SOP Classes on disk. Any Remote DICOM AE can send images to the DICOM SERVER AE.

Note:

When the IP filtering feature is activated on the Senographe Essential, the TCP/IP traffic is only allowed for network hosts declared on the acquisition system.

2-3-1-1-6-1. Real-World Activity Image Installation

The DICOM SERVER AE accepts an association when it receives a valid association request from a DICOM Storage SCU.

2-3-1-1-6-1-1. Associated Real-World Activity

The DICOM SERVER AE waits for any association. No operator action is required to receive an image.

2-3-1-1-6-1-2. Accepted Presentation Context Table

Table 6 Accepted Presentation Context Table

Presentation Context Table - Accepted					
Abstract Syntax		Transfer Syntax		Role	Extended Negotiation
Name	UID	Name List	UID List		
Digital Mammography X-Ray Image Storage - For Presentation	1.2.840.10008.5.1.4.1.1 .1.2	Implicit VR Little Endian	1.2.840.10008.1. 2	SCP	None
Digital Mammography X-Ray Image Storage - For Processing	1.2.840.10008.5.1.4.1.1 .1.2.1	Implicit VR Little Endian	1.2.840.10008.1. 2	SCP	None

Presentation Context Table - Accepted					
Abstract Syntax		Transfer Syntax		Role	Extended Negotiation
Name	UID	Name List	UID List		
Secondary Capture Image Storage	1.2.840.10008.5.1.4.1.1.7	Implicit VR Little Endian	1.2.840.10008.1.2	SCP	None

Note:

Other presentation context not documented in this table may be accepted (e.g., Digital X-Ray / Implicit VR Little Endian) but there are some limitations on the system working with such images.

2-3-1-1-6-1-2-1. SOP Specific DICOM Conformance Statement for all Storage SOP Classes

Following are the status codes the Application may send back to the SCU Equipment after performing the requested Storage:

Table 7 Status Codes returned to SCU Equipment after Storage

Service Status	Status Codes	Further Meaning	Status Code sending explanation	Related Fields sent back to the SCU
Refused	A7xx	Out of resources	indicates that there was not enough space or some other internal resource (such as memory) to store the image. The user should attempt recovery by removing some images from the Senographe Essential Acquisition Workstation	(0000,0902)
Error	C000	Processing Failure	indicates that an internal system call has failed while processing the image.	(0000,0902)
Success	0000			None

Each C-STORE SCP supports an Association Timer, Operation Timer, Session Timer that can be configured at installation time. These timers are defaulted to 60, 180, 3600 seconds.

The DICOM Server AE conforms to the SOP's of the Storage Service Class at Level 2 (Full) as described in Section B4.1 of PS 3.4 of the DICOM Standard Document.

Image Reception phase:

- If the DICOM Server AE fails to parse the received image, the error C000 (Processing Failure) is returned to the C-STORE SCU.
- If the DICOM Server AE fails to install the received image into the local database, the error A700 (Out of Resources) is returned to the C-STORE SCU.

When a C-STORE operation is returned Successful to the C-STORE SCU, the image has been written to the disk and declared into the local database. The image will then be accessed in the same manner as any other image by the applications on the Senographe Essential Acquisition Workstation.

When a C-STORE operation is returned Error to the C-STORE SCU, the image will be removed and a message will appear in the browser message log informing the user of a failure. If a SOP instance containing unknown private elements is received, it will be further sent back using a VR="UN" if an explicit syntax transfer is accepted by the remote SCP.

2-3-1-1-6-1-3. Presentation Context Acceptance Criterion

Only known SOP Classes are accepted.

2-3-1-1-6-1-4. Transfer Syntax Selection Policies

The default transfer syntax for SOP Classes is always Implicit VR Little Endian: (1.2.840.10008.1.2).

2-3-1-1-6-2. Real-World Activity Verification

The DICOM Server AE accepts an association when it receives a valid association request from a DICOM Verification SCU.

2-3-1-1-6-2-1. Associated Real-World Activity

The DICOM Verification AE waits for any association.

2-3-1-1-6-2-2. Accepted Presentation Context Table

Table 8 Accepted Presentation Context Table

Presentation Context Table - Accepted					
Abstract Syntax		Transfer Syntax		Role	Extended Negotiation
Name	UID	Name List	UID List		
Verification SOP Class	1.2.840.10008.1.1	Implicit VR Little Endian	1.2.840.10008.1.2	SCP	None

2-3-1-1-6-2-2-1. SOP Specific DICOM Conformance Statement for verification SOP Classes

Following are the status codes the Application may send back to the SCU Equipment after receiving the requested Verification:

Table 9 Status Codes returned to SCU Equipment after Storage

Service Status	Status Codes	Further Meaning	Status Code sending explanation	Related Fields sent back to the SCU
Success	0000			None

Each C-ECHO SCP supports an Association Timer, Operation Timer, Session Timer that can be configured at installation time. These timers are defaulted to 60, 180, 3600 seconds.

2-3-2 WORKLIST SERVER AE Specification

This Application Entity provides Standard Conformance to the following DICOM SOP Classes as a SCU:

SOP Class Name	SOP Class UID
Modality Worklist Information Model - FIND	1.2.840.10008.5.1.4.31

2-3-2-1 Association Establishment Policies**2-3-2-1-1. General**

The DICOM Application Context Name (ACN), which is always proposed, is:

Application Context Name	1.2.840.10008.3.1.1.1
--------------------------	-----------------------

The Maximum Length PDU negotiation is included in all association establishment requests.

The maximum length PDU for an association initiated by the WORKLIST SERVER AE is:

Maximum Length PDU	28Kbytes
--------------------	----------

The SOP Class Extended Negotiation is not supported.

The maximum number of Presentation Context Items that will be proposed is 1

The user information Items sent by this product are:

- Maximum PDU Length
- Implementation UID

2-3-2-1-2. Number of Associations

The WORKLIST SERVER AE (SCU) will initiate only one DICOM association at a time to perform a modality worklist query of a single remote AE.

2-3-2-1-3. Asynchronous Nature

Asynchronous mode is not supported. All operations will be performed synchronously.

2-3-2-1-4. Implementation Identifying Information

The Implementation UID for this DICOM Implementation is:

Senographe Essential Acquisition Workstation Implementation UID	Depending on the hardware revision of Acquisition Workstation: - V1/V2 (SUN BLADE 150): 1.2.840.113619.6.254 - V3 (U20)/V4 (Z400): 1.2.840.113619.6.255
--	--

2-3-2-1-5. Association Initiation by Real-World Activity**2-3-2-1-5-1. Real-World Activity: Worklist Query****2-3-2-1-5-1-1. Associated Real-World Activity**

The operator of the system initiates a query for a modality worklist by pressing the REFRESH WORKLIST button of the Worklist screen. The Worklist Server will then initiate an association with the remote AE in order to query for the worklist.

A user can configure a number of parameters which directly control the worklist query request. The user can request worklist items that are intended for the system the user is working at, all items that apply to the modality of the system the user is working at or all worklist items available. These selections and their affects on worklist query parameters are given below:

- This System (see [8-5-1-1 This System: on page 121](#))
- This Modality (see [8-5-1-2 This Modality: on page 121](#))
- All Systems (see [8-5-1-3 All Systems: on page 121](#))
- Today (see [8-5-1-4 Today: on page 121](#))
- Tomorrow (see [8-5-1-5 Tomorrow: on page 121](#))
- Between two dates (see [8-5-1-6 Between two dates: on page 121](#))
- Patient Name (see [8-5-1-7 Patient Name: on page 121](#))
- Patient ID (see [8-5-1-8 Patient ID: on page 121](#))
- Accession number (see [8-5-1-9 Accession number: on page 121](#))
- Requested Procedure ID (see [8-5-1-10 Requested Procedure ID: on page 122](#))

2-3-2-1-5-1-2. Proposed Presentation Context Table

The following table shows the proposed presentation contexts for the Worklist Server AE after real-world activity Worklist Query has been initiated.

Table 10 Proposed Presentation Context Table

Presentation Context Table - Proposed					
Abstract Syntax		Transfer Syntax		Role	Extended
Name	UID	Name List	UID List		Negotiation
Modality Worklist Information Model - FIND	1.2.840.10008.5.1.4.31	Implicit VR Little Endian	1.2.840.10008.1.2	SCU	None

2-3-2-1-5-1-2-1. SOP Specific DICOM Conformance Statement for the Worklist SOP Class

Following are the status codes that are more specifically processed when receiving messages from a **Modality Worklist SCP** equipment:

Table 11 Status Codes processed when receiving from Modality Worklist Equipment

Service Status	Status Codes	Further Meaning	Application behavior when receiving status codes	Related Fields Processed if received
Refused	A700	Out of resources	Association is closed. The Worklist is emptied. Error is logged.	(0000,0902)
Failed	A900	Identifier does not match SOP Class	Association is closed. The Worklist is emptied. Error is logged.	(0000,0901) (0000,0902)
	Cxxx	Unable to process	Association is closed. The Worklist is emptied Error is logged.	(0000,0901) (0000,0902)
Cancel	FE00	Matching terminated due to Cancel request	Association is closed. The Worklist is emptied Error is logged.	None
Success	0000	Matching is complete - No final identifier is supplied.		None

Service Status	Status Codes	Further Meaning	Application behavior when receiving status codes	Related Fields Processed if received
Pending	FF00	Matches are continuing - Current Match is supplied and any Optional Keys were supported in the same manner as Required Keys.		Identifier
	FF01	Matches are continuing - Warning that one or more Optional Keys were not supported for existence for this Identifier.		Identifier

Note:

When any other status code is received, Association is closed. The old Worklist is not displayed anymore. Error is logged.

If the remote AE does not support the proposed Presentation Context, an appropriate error is logged and the operator is notified.

This implementation can receive multiple C-FIND results over a single association. Only one association is opened at a time.

Each C-FIND response received from the remote AE is parsed to verify the length/type of the items in the response. Upon detecting any error in the response data, the Worklist Server AE will ignore the bad data and carry on to the next C-FIND response.

On receipt of any error from the remote AE, the Worklist Server will issue a C-FIND-CANCEL and, upon receipt of a C-FIND-RSP (or if an applicable timer expires), will abort the association. Warnings received from the remote AE are ignored.

Each C-FIND operation supports a configurable Association Timer. This timer starts when the association request is sent or received and stops when the association is established. The default time-out value is 30 seconds.

Each C-FIND operation supports a configurable Session Timer. This timer starts when an association is established and stops when the association is ended. The default time-out value is 3600 seconds.

If any of the above timers expires, the association is aborted (A-ABORT) and the operation in progress is considered to be failed. Any previously received worklist items are kept.

2-3-2-1-5-1-2-2. Record Acceptance Policy

All worklist items coming from the remote AE are accepted.

! **Notice:**

Any returned dataset not compliant with the DICOM return type (i.e. missing return type 1 and 2 elements) will be silently rejected by the WORKLIST SERVER AE and thus not displayed to the user.

2-3-2-2 Association Acceptance Policy

The Worklist Server AE does not respond to attempts by a remote AE to open an association.

2-3-3 STORAGE COMMITMENT SERVER AE Specification

This Application Entity provides Standard Conformance to the following DICOM SOP Classes as a SCU:

SOP Class Name	SOP Class UID
Storage Commitment Push Model	1.2.840.10008.1.20.1

2-3-3-1 Association Establishment Policies**2-3-3-1-1. General**

The DICOM Application Context Name (ACN), which is always proposed, is:

Application Context Name	1.2.840.10008.3.1.1.1
--------------------------	-----------------------

The Maximum Length PDU negotiation is included in all association establishment requests.

The maximum length PDU for an association initiated by the STORAGE COMMITMENT SERVER AE is:

Maximum Length PDU	28Kbytes
--------------------	----------

The SOP Class Extended Negotiation is not supported.

The maximum number of Presentation Context Items that will be proposed is 1

The user information Items sent by this product are:

- Maximum PDU Length
- Implementation UID

2-3-3-1-2. Number of Associations

The STORAGE COMMITMENT SERVER AE will initiate only one DICOM association at a time to perform a DICOM storage commitment operation as a SCU to a Remote Host AE.

2-3-3-1-3. Asynchronous Nature

Asynchronous mode is not supported. All operations will be performed synchronously.

2-3-3-1-4. Implementation Identifying Information

The Implementation UID for this DICOM Implementation is:

Senographe Essential Acquisition Workstation Implementation UID	Depending on the hardware revision of Acquisition Workstation: - V1/V2 (SUN BLADE 150): 1.2.840.113619.6.254 - V3 (U20)/V4 (Z400): 1.2.840.113619.6.255
--	--

2-3-3-1-5. Association Initiation by Real-World Activity

2-3-3-1-5-1. Real-World Activity: Images successfully sent to a remote host declared as a Storage Commitment Provider

2-3-3-1-5-1-1. Associated Real-World Activity

The operator or GE Field Engineer can declare a Remote Host as Storage Commitment Provider on the Senographe Essential Acquisition Workstation.

The operator selects in the BROWSER one or several Patient Folders (or Studies/Series/Images) to be sent. Then, the user can either drag and drop the selection on the icon representing then Remote DICOM AE, or click on the Push icon and select a Remote DICOM AE in the LIST OF REMOTE HOST. The selected Remote DICOM AE must be declared as Storage Commitment Provider.

This operation causes:

- The Senographe Essential Acquisition Workstation to retrieve the selected image from its local database.
- The DICOM SERVER AE to initiate a DICOM association, negotiate with the Remote AE an appropriate Abstract and Transfer Syntax.
- To emit C-STORE command to send the image, if the negotiation is successful.
- When all images have been successfully sent, the DICOM SERVER AE asks the STORAGE COMMITMENT SERVER AE to commit the images.
- The STORAGE COMMITMENT SERVER AE initiates a DICOM association, negotiate with the Remote AE an appropriate Abstract and Transfer Syntax.
- If the negotiation is successful, STORAGE COMMITMENT SERVER AE emits a N-ACTION request. Only one N-ACTION Request is sent for all images to be committed.

2-3-3-1-5-1-2. Proposed Presentation Context Table:

Table 12 Proposed Presentation Context Table

Abstract Syntax		Transfer Syntax		Role	Extended Negotiation
Name	UID	Name List	UID List		
Storage Commitment Push Model	1.2.840.10008.1.20.1	Explicit VR Big Endian	1.2.840.10008.1.2.2	SCU	None
Storage Commitment Push Model	1.2.840.10008.1.20.1	Implicit VR Little Endian	1.2.840.10008.1.2	SCU	None
Storage Commitment Push Model	1.2.840.10008.1.20.1	Explicit VR Little Endian	1.2.840.10008.1.2.1	SCU	None

2-3-3-1-5-1-2-1. SOP Specific DICOM Conformance Statement for the Storage Commitment Push Model SOP Class

If the association negotiation is not successful the STORAGE COMMITMENT SERVER AE retries the association negotiation 3 times. After the 3 retries, if association negotiation still fails, an error file is logged, the Storage Commitment is abandoned and a pop-up is displayed to the user.

After the N-ACTION request, if the received N-ACTION Response from the Storage Commitment Provider has a failure status, an error file is logged, the Storage Commitment is abandoned and a pop-up is displayed to the user.

After the N-ACTION request, if the received N-ACTION Response from the Storage Commitment Provider has a success status, the STORAGE COMMITMENT SERVER AE can receive the N-EVENT-REPORT from the Storage Commitment Provider at any time (See section *Real-World Activity Image Remotely Committed*) There is no time out to limit the period of time between the reception of the N-ACTION Response and the reception of the N-EVENT-REPORT from the Storage Commitment Provider.

2-3-3-1-6. Association Acceptance Policy

2-3-3-1-6-1. Real-World Activity Image Remotely Committed

The STORAGE COMMITMENT SERVER AE accepts an association for Storage Commitment notification (N-EVENT-REPORT) **only as a SCU**. The Storage Commitment Provider initiating the association must use the role selection negotiation.

The STORAGE COMMITMENT SERVER AE accepts an association when it receives a valid association request from a STORAGE COMMITMENT Provider.

2-3-3-1-6-1-1. Associated Real-World Activity

The STORAGE COMMITMENT SERVER AE waits for any association. No operator action is required to receive a storage commitment notification.

2-3-3-1-6-1-2. Accepted Presentation Context Table

Table 13 Accepted Presentation Context Table

Presentation Context Table - Accepted					
Abstract Syntax		Transfer Syntax		Role	Extended Negotiation
Name	UID	Name List	UID List		
Storage Commitment Push Model	1.2.840.10008.1.20.1	Explicit VR Big Endian	1.2.840.10008.1.2.2	SCU	None
Storage Commitment Push Model	1.2.840.10008.1.20.1	Implicit VR Little Endian	1.2.840.10008.1.2	SCU	None
Storage Commitment Push Model	1.2.840.10008.1.20.1	Explicit VR Little Endian	1.2.840.10008.1.2.1	SCU	None

Note:

The Storage Commitment Provider initiating the association must use the role selection negotiation.

2-3-3-1-6-1-2-1. N-Event-Report Status Codes supported

Following are the status codes the Application may send back to the SCP Equipment after receiving the N-EVENT-REPORT:

Table 14 Status Code values returned to SCP Equipment in the N-Event-Report Response

Service Status	Status Codes	Further Meaning	Status Code sending explanation	Related Fields sent back to the SCP
Error	0110	Processing Failure	indicates that an internal system call has failed while processing the storage commitment notification	None
Success	0000			None

Storage Commitment Notification notifies the STORAGE COMMITMENT SERVER AE if the Storage Commitment Provider has successfully committed the images or not.

If an image has been successfully committed, the STORAGE COMMITMENT SERVER AE asks the local database to flag the image as Committed.

If an image has NOT been committed, the STORAGE COMMITMENT SERVER AE logs the error file and displays a pop-up to the user.

If the STORAGE COMMITMENT SERVER AE has successfully processed the notification as described above, Success is sent back to the Storage Commitment Provider else Error.

2-3-3-1-6-1-3. Presentation Context Acceptance Criterion

The Storage Commitment Provider initiating the association must use the role selection negotiation

2-3-3-1-6-1-4. Transfer Syntax Selection Policies

Explicit Big Endian transfer syntax is chosen first, then the Explicit Little Endian and then the Implicit Little Endian.

2-3-3-1-6-2. Real-World Activity Verification

The DICOM Storage Commitment Server AE accepts an association when it receives a valid association request from a DICOM Verification SCU.

2-3-3-1-6-2-1. Associated Real-World Activity

The DICOM Verification AE waits for any association.

2-3-3-1-6-2-2. Accepted Presentation Context Table

Table 15 Accepted Presentation Context Table

Presentation Context Table - Accepted					
Abstract Syntax		Transfer Syntax		Role	Extended Negotiation
Name	UID	Name List	UID List		
Verification SOP Class	1.2.840.10008.1.1	Implicit VR Little Endian	1.2.840.10008.1.2	SCP	None
Verification SOP Class	1.2.840.10008.1.1	Explicit VR Little Endian	1.2.840.10008.1.2.1	SCP	None
Verification SOP Class	1.2.840.10008.1.1	Implicit VR Little Endian	1.2.840.10008.1.2.2	SCP	None

2-3-4 MPPS SERVER AE Specification

This application entity provides standard conformance to the following DICOM SOP Class as a **SCU**:

SOP Class Name	SOP Class UID
Modality Performed Procedure Step	1.2.840.10008.3.1.2.3.3

2-3-4-1 Association Establishment policies

2-3-4-1-1. General

The DICOM application context name (CAN), which is always proposed, is:

Application context name	1.2.840.10008.3.1.1.1

The maximum Length PDU negotiation is included in all association establishment requests.

The maximum Length PDU for an association initiated by the MPPS SERVER AE is:

Maximum Length PDU	28Kbytes

The SOP Class Extended negotiation is not supported.

The maximum number of Presentation Context Items that will be proposed is 1.

The user information Items sent by this product are:

- Maximum PDU Length
- Implementation UID

2-3-4-1-2. Number of associations

The MPPS SERVER AE will initiate only one DICOM association at a time to perform a DICOM Modality Performed Procedure Step operation as a SCU to a remote host AE.

2-3-4-1-3. Asynchronous nature

Asynchronous mode is not supported. All operations will be performed synchronously.

2-3-4-1-4. Implementation Identifying information

The implementation UID for this DICOM implementation is:

Senographe Essential Acquisition Workstation Implementation UID	Depending on the hardware revision of Acquisition Workstation: - V1/V2 (SUN BLADE 150): 1.2.840.113619.6.254 - V3 (U20)/V4 (Z400): 1.2.840.113619.6.255
--	--

2-3-4-1-5. Association initiation by Real-World Activity: Performed Procedure Step creation and update

2-3-4-1-5-1. Associated real-world activity

The real world activities are mentioned in section [2-2-3 Sequencing of Real-World Activities on page 20](#). Each of the real world activities results in either creating a new Performed Procedure Step SOP instance at the remote SCP or updating an already created Performed Procedure Step SOP instance as per the DICOM standard.

2-3-4-1-5-2. Proposed presentation context table

Table 16 Proposed presentation context table

Abstract syntax		Transfer syntax		Role	Extended negotiation
Name	UID	Name List	UID List		
Modality Performed Procedure Step	1.2.840.10008.3.1.2.3.3	Explicit VR Big Endian	1.2.840.10008.1.2.2	SCU	None
Modality Performed Procedure Step	1.2.840.10008.3.1.2.3.3	Explicit VR Little Endian	1.2.840.10008.1.2	SCU	None
Modality Performed Procedure Step	1.2.840.10008.3.1.2.3.3	Implicit VR Little Endian	1.2.840.10008.1.2.1	SCU	None

2-3-4-1-5-2-1. SOP specific DICOM Conformance statement for MPPS SOP Class

If the association negotiation is not successful, the MPPS SERVER AE retries the association the user-defined number of times, using the user-defined delay between retries. Also, an error is logged into the local logfiles. If the association still fails when the maximum number of retries is reached, the PPS is abandoned. This is the case for both the N-CREATE and the N-SET messages.

The user is never warned of failed messages (either N-SET or N-CREATE); only access to the appropriate logfiles stored on the Senographe Essential will show failed messages.

2-3-4-1-6. Association acceptance policy

The PPS Server AE does not respond to attempts by remote AE to open an association.

2-3-5 PRINT SERVER AE Specification

This Application Entity provides Standard Conformance to the following DICOM SOP Classes as a SCU:

SOP Class Name	SOP Class UID
Basic Grayscale Print Management Meta SOP Class	1.2.840.10008.5.1.1.9
Presentation LUT SOP Class	1.2.840.10008.5.1.1.23

Note:

Support of the Basic Grayscale Print Management Meta SOP Class as an SCU mandates support for the Basic Film Session, Basic Film Box, Basic Grayscale Image Box and Printer SOP Classes as a SCU.

2-3-5-1 Association Establishment Policies

2-3-5-1-1. General

The DICOM Application Context Name (ACN), which is always proposed, is:

Application Context Name	1.2.840.10008.3.1.1.1
---------------------------------	------------------------------

The Maximum Length PDU negotiation is included in all association establishment requests.

The Maximum Length PDU for an association initiated by the DICOM Print SCU is:

Maximum Length PDU	16384
---------------------------	--------------

The Print Management Service Class does not support extended negotiation.

The maximum number of Presentation Context Items that will be proposed is: 3

The user information Items sent by this product are:

- Maximum PDU Length
- Implementation UID
- Implementation Version Name

Note:

The maximum PDU length can be modified when installing the system. The default value is set at 0 which indicates that no maximum length is specified.

2-3-5-1-2. Number of Associations

The DICOM Print SCU AE supports only one association at a time. Request are internally queued.

2-3-5-1-3. Asynchronous Nature

Asynchronous mode is not supported. All operations will be performed synchronously.

2-3-5-1-4. Implementation Identifying Information

The Implementation UID for this DICOM Implementation is:

Senographe Essential Acquisition Workstation Implementation UID	Depending on the hardware revision of Acquisition Workstation: - V1/V2 (SUN BLADE 150): 1.2.840.113619.6.254 - V3 (U20)/V4 (Z400): 1.2.840.113619.6.255
--	--

The Implementation Version Name for this DICOM Implementation is:

Senographe Essential Acquisition Workstation Implementation Version Name	1_2_10
---	---------------

2-3-5-2 Association Initiation Policy

The DICOM Print SCU AE initiates one association with the selected REMOTE DICOM Printer. No other association can be opened by the DICOM Print SCU AE while the current association is active.

2-3-5-2-1. Real-World Activity Manual Image Print

2-3-5-2-1-1. Associated Real-World Activity

The operator does the following:

1. Selects an image in Viewer.
2. Clicks on Print Button
3. Print window is displayed. User checks or modifies selected printer and print parameters (film format, number of copies, pixel depth, etc.).
4. Clicks on Print to confirm.

This operation causes:

- The DICOM PRINT SCU AE to try to establish the association with the requested printer
- To emit N-GET command to get printer status from the Printer SOP Instance if the negotiation is successful.
- To emit N-CREATE command for Presentation LUT SOP Instance if the printer status is not FAILURE, or WARNING with Printer Status Info equal to SUPPLY LOW or SUPPLY EMPTY.
- To emit N-CREATE command for Basic Film Session SOP Instance if the previous N-CREATE is successful.
- To emit N-SET Basic Film Box SOP Instance with the Image Box SOP Instance for each image on the film.
- To emit N-ACTION on Basic Film Box SOP Instance to request the SCP to print one or more copies of a single film of the film session.
- To emit N-DELETE on the Basic Film Box SOP Instance if DICOM_PRINT_WAIT_SCP_EVENT environment variable is set.
- To wait for N-EVENT-REPORT from the printer SOP Instance indicating printer status.
- To emit N-GET to receive the printer status if no N-EVENT-REPORT has been received after a configurable time out.
- To release the DICOM association after printing is successful or failure has been signaled to the user.

This operation will cause the DICOM PRINT SCU AE to try to establish the association with the requested printer and sends the images for printing.

2-3-5-2-1-2. Proposed Presentation Context Table

Presentation Context Table - Proposed					
Abstract Syntax		Transfer Syntax		Role	Extended Negotiation
Name	UID	Name List	UID List		
Basic Grayscale Print Management Meta SOP Class	1.2.840.10008.5.1.1.9	Implicit VR Little Endian	1.2.840.10008.1.2	SCU	None
Presentation LUT SOP Class	1.2.840.10008.5.1.1.23	Implicit VR Little Endian	1.2.840.10008.1.2	SCU	None

2-3-5-2-1-2-1. SOP Specific DICOM Conformance Statement for Print Management SOP Classes
Following are the status codes that are more specifically processed:

Table 17 Status Codes processed when receiving N-CREATE response for Basic Film Session SOP

Service Status	Status Codes	Further Meaning	Application Behavior When receiving Status Codes
Warning	B600	Memory allocation not supported	Association is aborted
Success	0000	Film session successfully created	Next step described in the sequencing of Real-World Activities paragraph is performed

Note:

All other status codes returned by the remote host will result in the association being silently aborted.

Table 18 Status Codes processed when receiving N-CREATE response for Basic Film Box SOP

Service Status	Status Codes	Further Meaning	Application Behavior When receiving Status Codes
Failure	0110	Processing failure	Retried
Failure	0213	Resource limitation	Retried
Failure	0211	Unrecognized operation	Retried
Success	0000	Success	Next step described in the sequencing of Real-World. Activities paragraph is performed

Note:

All other status codes returned by the remote host will result in the association being silently aborted.

Table 19 Status Codes processed when receiving N-ACTION response for Basic Film Box SOP

Service Status	Status Codes	Further Meaning	Application Behavior When receiving Status Codes
Success	0000	Film accepted for printing.	Next step described in the sequencing of Real-World Activities paragraph is performed
Warning	B603	Film Box SOP Instance hierarchy does not contain Image Box SOP Instances (empty page)	This case should not happen. This warning is considered as an error. Association is aborted.
Failure	C602	Unable to create Print Job SOP Instance; print queue is full	Appropriate message is returned to the user. Association is aborted.
	C604	Image position collision: multiple images assigned to single image position	Appropriate message is returned to the user. Association is aborted.
	C603	Image size is larger than image box size (by using the specified magnification value)	Appropriate message is returned to the user. Association is aborted.
	0110	Processing failure	Retried
	0213	Resource limitation	Retried
	0211	Unrecognized operation	Retried

Note:

All other status codes returned by the remote host will result in the association being silently aborted.

Table 20 Status Codes processed when receiving N-SET response for Basic Grayscale Image Box SOP Class

Service Status	Status Codes	Further Meaning	Application Behavior When receiving Status Codes
Failure	C605	Insufficient memory in printer to store the image	Appropriate message is returned to the user. Association is aborted.
Failure	0110	Processing failure	Retried
Failure	0213	Resource limitation	Retried
Failure	0211	Unrecognized operation	Retried
Success	0000	Success	Next step described in the sequencing of Real-World. Activities paragraph is performed

Note:

All other status codes returned by the remote host will result in the association being silently aborted.

Table 21 Status Codes processed when receiving N-CREATE response for Presentation LUT SOP

Service Status	Status Codes	Further Meaning	Application Behavior When receiving Status Codes
Failure	0110	Processing failure	Retried
Failure	0213	Resource limitation	Retried
Failure	0211	Unrecognized operation	Retried
Success	0000	Success	Next step described in the sequencing of Real-World. Activities paragraph is performed

Note:

All other status codes returned by the remote host will result in the association being silently aborted.

2-3-5-2-2. Real-World Activity Automatic Image Print

2-3-5-2-2-1. Associated Real-World Activity

The operator does the following:

1. Set Auto-Print ON and define the auto-print parameters using MEDICAL APPLICATION PREFERENCES option of the Browser toolkit menu.
2. Starts an exam
3. Acquires images
4. Clicks on CLOSE EXAM

This operation will cause the DICOM PRINT SCU AE to try to establish the association with the requested printer and sends the acquired images for printing as described in Manual Image Print real world activity.

2-3-5-2-2-2. Proposed Presentation Context Table

Same as Manual Image Print real world activity.

2-3-5-2-2-2-1. SOP Specific DICOM Conformance Statement for Print Management SOP Classes

Same as Manual Image Print real world activity.

2-4 Communication Profiles

2-4-1 Supported Communication Stacks (PS 3.8)

DICOM Upper Layer (PS 3.8) is supported using TCP/IP.

2-4-2 Physical Media Support

DICOM is indifferent to the Physical medium over which TCP/IP executes (e.g. Ethernet V2.0, IEEE 802.3, ATM, FDDI)

Note:

For more information about the Physical Media available on Senographe Essential Acquisition Workstation, please refer to the Product Data Sheet.

2-4-3 IPv4 and IPv6 Support

Only IPv4 is supported. IPv6 is not supported.

2-5 Extension / Specializations / Privatization

2-5-1 Standard Extended /Specialized/Private SOPs

- The Digital Mammography X-ray Image Storage - for Presentation and the Digital Mammography X-ray Image Storage - for Processing SOP classes are supported as DICOM standard extended SOP classes. The list of private attributes can be found in Table [27 on page 79](#).
- The Breast Tomosynthesis Image Storage SOP class is supported as DICOM standard extended SOP class. The list of private attributes can be found in Table [21 on page 105](#).
- The Modality Performed Procedure Step SOP class is supported as a DICOM standard extended SOP class. The additional attributes sent can be found in Table [1 on page 141](#).

2-5-2 Private Transfer Syntaxes

None supported

2-6 Configuration

Note:

hostname is the system hostname and it is configured by a GE Field Engineer during installation.

Note:

The value chosen for the system hostname should not exceed 12 characters in order for all pre-configured AE title not to be truncated.

2-6-1 AE Title/Presentation Address Mapping

DICOM SERVER AE:

AE Title is set to hostname.

WORKLIST SERVER AE:

AE Title is set to hostname by default.

STORAGE COMMITMENT SERVER AE:

AE Title is set to SCU_hostname.

MPPS SERVER AE:

AE Title is set to SCU_hostname by default.

PRINT SERVER AE:

AE Title is set to PR_hostname by default.

2-6-2 Configurable Parameters

The following fields are configurable for this AE (local):

- Local IP Address
- Local IP Netmask

The Local Listening Port Number for C-STORE SCP DICOM service is not configurable and set to **4006**

The Local Listening Port Number for STORAGE COMMITMENT DICOM service is not configurable and set to **4008**

The Print SCU AE Title value is defined in the file:

```
~sdc/app-defaults/dicom_print/dprint.cfg
```

The Worklist SCU AE Title can be modified using the script:

```
~sdc/senovision/scripts/SetWorklistAETitle.sh
```

The following fields are configurable for every remote DICOM AE including Worklist provider, MPDS remote AEs and Printers:

- Remote AE Title
- Remote IP Address
- Listening TCP/IP Port Number

Only one **default router** IP Address can be configured for **all remote nodes**.

DHCP is not supported.

The following fields are configurable:

- Association Establishment Timer
- Store, Find, Move, Timers
- N-SET timer (default set to 300s)
- N-ACTION timer (default set to 300s)
- N-GET timer (default set to 300s)
- N-DELETE timer (default set to 300s)
- N-EVENT timer (default set to 30s)
- Inactivity Timers (default set to 3000s)
- Maximum Length PDU

2-7 Support of Extended Character Sets

The Senographe Essential Acquisition Workstation will support only the ISO_IR 100 (ISO 8859-1:1987 Latin alphabet N 1. supplementary set) as extended character sets.

While processing a C-STORE Request, if the system fails to decode a character because of the use of another character sets, the system sends a C-STORE Response with the failure status 0110H that stands for Processing Failure.

If a worklist SPS from RIS contains a character that the system fails to decode because of the use of another character sets, the SPS is displayed in the worklist but the character is ignored by the system and thus is not displayed/saved.

2-8 Security Profiles

The product does not conform to any defined DICOM Security Profiles.

It is assumed that the product is used within a secured environment. It is assumed that a secured environment includes at a minimum:

1. Firewall or router protections to ensure that only approved external hosts have network access to the product.
2. Firewall or router protections to ensure that the product only has network access to approved external hosts and services.
3. Any communications with external hosts and services outside the locally secured environment use appropriate secure network channels (such as a Virtual Private Network (VPN)).

3 Media Storage Conformance Statement

3-1 Introduction

This section of the conformance statement (CS) specifies the Senographe Essential Acquisition Workstation compliance to DICOM Media Interchange. It details the DICOM Media Storage Application Profiles and roles which are supported by this product.

This station provides capabilities to DICOM interchange on CD-Rs (Compact Disc-Recordable), supporting Digital Mammography X-Ray (MG) For Processing, Digital Mammography X-Ray (MG) For Presentation images and Secondary Capture Image. Breast Tomosynthesis Image is not supported.

Note:

Although Breast Tomosynthesis Image is not supported for DICOM interchange on CD-R, the corresponding Projections which enable reconstructing the 3D image can be interchanged on CD-Rs as Digital Mammography X-Ray (MG) images For Processing.

The format of this section strictly follows the format defined in DICOM Standard PS 3.2 (Conformance). Please refer to that part of the standard while reading this section.

3-2 Implementation Model

3-2-1 Application Data Flow Diagram

The Basic and Specific Application models for the CD-R device are shown in the following Illustration: Specific AE Application Model for the CD-R device

- Description of the Data Flow Diagram for the CD-R device.

The DICOM ARCHIVE/RESTORE functionality for the CD-R device is handled by the CD-R DICOM Media Server Application Entity (AE). The CD-R DICOM Media Server Application Entity (AE) is commanded by the user to perform DICOM services operating on the DICOM media through the use of buttons and menu selections on the graphical user interface of the station.

The user requests the creation of a DICOM file set and the writing of this DICOM File Set on a blank CD-R by selecting images in the local Browser, and by a drag and drop of those images on the CD-R icon. Images are saved on a mono-session disk in a one shot operation.

The user can request the reading of a DICOM file set written on a CD-R by selecting the CD-R drive as the active archive device, and browsing the archive using the Query Item of the Archive drop down menu, and then restore the selected items by a drag and drop on the local browser icon or by clicking on the suitable restore buttons.

The Application models for the CD-R device are shown in [Illustration 1](#).

Illustration 1 Specific AE Application Model for the CD-R device

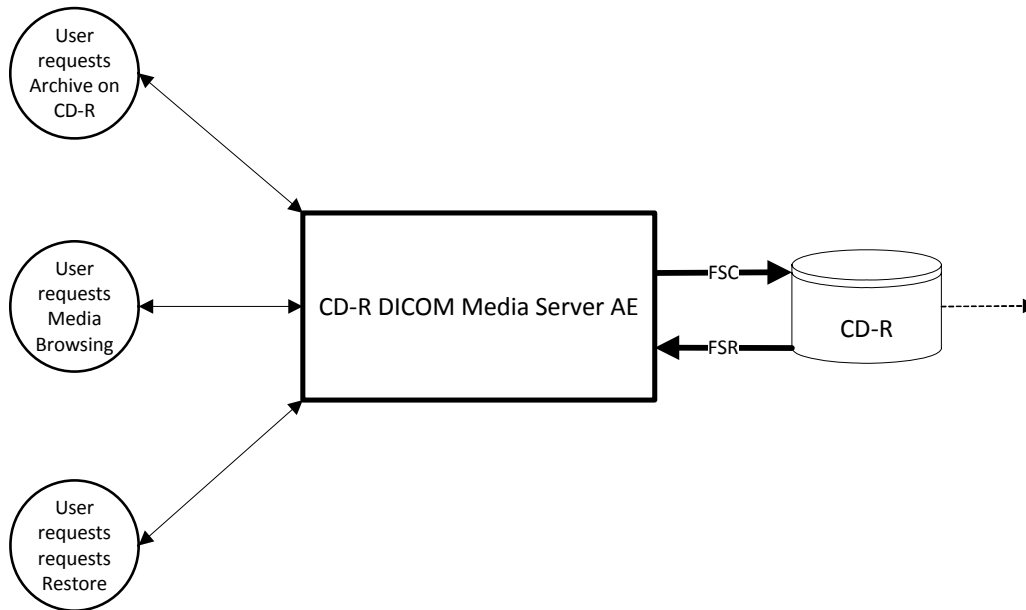

3-2-2 Functional Definition of AEs

3-2-2-1 Functional Definition of the DICOM Media Server AE

3-2-2-1-1. Functional definition of the CD-R DICOM Media Server AE

The CD-R DICOM Media Server Application Entity supports the following functions:

- Has access to patient demographics and pixel data in the local database.
- Can generate a DICOM File Set (FSC) for Digital Mammography X-Ray (MG) For Processing and MG For Presentation data types in a one shot activity.
- Can write a DICOM File Set (FSC) on a CD-R in mono-session.
- Can read a DICOM File Set (FSR) on a CD-R.

3-2-3 Sequencing Requirements

Non Applicable for writing a CD-R.

For restoring images from a CD-R:

1. Browse the CD-R
2. User selects images to be restored from CD-R to the system.
3. System restores Images.

3-2-4 File Meta Information Options (See PS3.10)

The File Meta-Information for this implementation is:

File Meta-Information Version	1
Senographe Essential Acquisition Workstation Implementation UID	Depending on the hardware revision of Acquisition Workstation: - V1/V2 (SUN BLADE 150): 1.2.840.113619.6.254 - V3 (U20)/V4 (Z400): 1.2.840.113619.6.255
Implementation Version Name	The Implementation Version Name is set dynamically through an environment variable

3-3 AE Specifications

3-3-1 DICOM CD-R SERVER AE Specification

The DICOM CDR/CDROM SERVER Application Entity provides standard conformance to DICOM Interchange Option of the Media Storage Service Class. The application Profiles and roles are listed below.

Table 1 Supported Application Profiles

Supported Application Profile	Real World Activity	Role	Description
STD-GEN-CD	Browse CD	FSR	Interchange
STD-GEN-CD	Restore CD	FSR	Interchange
STD-GEN-CD	Archive CD	FSC See Note	Interchange

Note:

1. Archive is available only on blank CD-Rs.
2. Browse and Restore is possible on CD-R.

3-3-1-1 File Meta Information for the DICOM CDR/CDROM Application Entity

Following are the values set in the File Meta Information for this AE Title:

Source Application Entity Title	Set to system hostname
---------------------------------	------------------------

3-3-1-2 Real-World Activities for the DICOM CD-R Application Entity

3-3-1-2-1. Real-World Activity (RWA) Browse CD

The CD-R DICOM Media Server AE acts as an FSR using the interchange option when requested to browse the CD.

When the CD-R DICOM Media Server AE is requested to provide a directory listing, it reads the File-set and displays the DICOMDIR directory entries, according to the PATIENT, STUDY, SERIES, IMAGE paradigm.

If the DICOMDIR file is not found in the File-set, the CD is ejected out of the drive.

3-3-1-2-1-1. Media Storage Application Profile for the RWA Browse CD:

For the list of Application Profiles that invoke this AE for the Browse CD RWA, refer to the Table in section 3-3-1.

3-3-1-2-1-1-1. Options:

Following are the SOP Classes supported by the RWA Browse CD:

Information Object Definition	SOP Class UID	Transfer Syntax	Transfer Syntax UID
Media Storage Directory Storage	1.2.840.10008.1.3.10	Explicit VR Little Endian	1.2.840.10008.1.2.1

Note:

Some fields are read directly from the images.

3-3-1-2-2. Real-World Activity (RWA) Restore CD

The CD-R/CDROM DICOM Media Server AE acts as an FSR using the interchange option when requested to copy SOP instances from the CD to the local database.

The user selects the SOP instances that he wants the DICOM Media Server AE to copy on the local data base by a drag and drop on the local browser icon or by clicking on the suitable restore buttons. Once selected, the SOP instances are copied from the media to the local database.

Only, the SOP classes supported by the station are declared to the database in a transfer syntax supported by the station.

3-3-1-2-2-1. Media Storage Application Profile for the RWA "Restore CD":

For the list of Application Profiles that invoke this AE for the Restore CD RWA, please refer to the Table in section 3-3-1.

3-3-1-2-2-1-1. Options:

Table 2 SOP Classes supported by the RWA Restore CD:

Information Object Definition	SOP Class UID	Transfer Syntax	Transfer Syntax UID
Digital Mammography X-ray For Processing Image Storage	1.2.840.10008.5.1.4.1.1.1.2.1	Explicit VR Little Endian	1.2.840.10008.1.2.1
Digital Mammography X-ray for Presentation Image Storage	1.2.840.10008.5.1.4.1.1.1.2	Explicit VR Little Endian	1.2.840.10008.1.2.1
Secondary Capture Image Storage	1.2.840.10008.5.1.4.1.1.7	Explicit VR Little Endian	1.2.840.10008.1.2.1

Note:

1. Only Secondary Captures whose modality is MG, DX, CR or OT are supported
2. Other objects such as Digital X-ray Images can be restored but there are some limitations on the system working with such objects.

3-3-1-2-3. Real-World Activity (RWA) Archive CD

The CD-R/CDROM DICOM Media Server acts as an FSC using the interchange option when requested to copy SOP Instances from the local data base to the CD-R.

The user has to insert a blank CD into the CD-R drive. Then, the user selects the entries in the local database that he wants the CD-R DICOM Media Server to copy onto the CD.

A confirmation pop-up that indicates what can be archived on the CD-R is displayed.

Before writing the CD, the DICOM Media Server checks for the following conditions:

- The inserted media is blank and writable. If the condition is not met, an error is displayed and the CD is ejected.
- The corresponding SOP instances have been encoded with the ISO_IR 100 Specific Character Set or DICOM Default Character Set.

The corresponding SOP instances are set to the transfer syntax defined by the application and copied to the CD. Unknown Private Data Elements are coded using a UN Value Representation.

3-3-1-2-3-1. Media Storage Application Profile for the RWA Archive CD:

For the list of Application Profiles that invoke this AE for the Archive CD RWA, please refer to the Table in section 3-3-1.

3-3-1-2-3-1-1. Options:

Note:**SOP Classes supported by the RWA Archive CD**

Information Object Definition	SOP Class UID	Transfer Syntax	Transfer Syntax UID
Digital Mammography X-ray For Processing Image Storage	1.2.840.10008.5.1.4.1.1.1.2.1	Explicit VR Little Endian	1.2.840.10008.1.2.1
Digital Mammography X-ray For Presentation Image Storage	1.2.840.10008.5.1.4.1.1.1.2	Explicit VR Little Endian	1.2.840.10008.1.2.1
Secondary Capture Image Storage	1.2.840.10008.5.1.4.1.1.7	Explicit VR Little Endian	1.2.840.10008.1.2.1

Table 3 Additional DICOMDIR Keys

Key Attribute	Tag	Directory Record Type	Type	Notes
Patient Birth Date	(0010,0030)	Patient	3	FSC/FSU: Always present. From image
Patient Sex	(0010,0040)	Patient	3	FSC/FSU: Always present. From image
Manufacturer	(0008,0070)	Series	3	FSC/FSU: Always present. From image
Institution Name	(0008,0080)	Series	3	FSC/FSU: Always present. From image
Institution Address	(0008,0081)	Series	3	FSC/FSU: Always present. From image
Series Description	(0008,103E)	Series	3	FSC/FSU: Always present. From image
Performing Physician Name	(0008,1050)	Series	3	FSC/FSU: Always present. From image
Body Part Examined	(0018,0015)	Series	3	FSC/FSU: Always present. From image
Image Type	(0008,0008)	Image	1C	FSC/FSU: Always present. From image
Image Laterality	(0020,0062)	Image	3	FSC/FSU: Always present. From image
Rows	(0028,0010)	Image	3	FSC/FSU: Always present. From image
Columns	(0028,0011)	Image	3	FSC/FSU: Always present. From image

3-4 Augmented and Private Application Profiles

No augmented/private profile is implemented

3-5 Extensions, Specializations, Privatizations of SOP Classes and Transfer Syntaxes

3-5-1 Extensions, Specializations, and Privatizations of SOP Classes

3-5-1-1 SOP Specific Conformance Statement for SOP Media Storage Directory

Note:

The CD-R Browser displays less information than the local Browser.

3-5-2 Private Transfer Syntax Specification

No private Transfer Syntax is written on media by the described DICOM CDR/CDROM SERVER AE of Senographe Essential Acquisition Workstation.

3-6 Configuration

The source AE Title encoded in the File Meta-Information can not be modified.

3-7 Support of Extended Character Sets

The Senographe Essential Acquisition Workstation will support only the ISO_IR 100 (ISO 8859-1:1987 Latin alphabet N 1. supplementary set) as extended character sets. Any incoming SOP instance that is encoded using another extended character set will not be installed in the local database.

While reading a DICOM file set written on a CD-R, if the system fails to decode a character because of the use of another character sets in the CD-R, reading fails and a message is displayed to the user.

4 Digital Mammography X-ray Information Object Implementation

4-1 Introduction

This section specifies the use of the DICOM Digital Mammography X-ray (MG) Image IOD to represent the information included in MG images produced by this implementation. Corresponding attributes are conveyed using the module construct. The contents of this section are:

4-2 MG IOD Implementation on page 55

4-3 MG Entity-Relationship Model on page 55

4-4 IOD Module Table on page 57

4-5 Information Module Definitions on page 59

4-6 Private Data Dictionary on page 81

4-7 Mammography View Codes on page 82

4-8 Limitations summary on page 83

4-2 MG IOD Implementation

The MG Image IOD is used in two SOP classes as defined in PS3.4 Storage Service Class, a SOP Class for storage of images intended for presentation, and a SOP class for storage of images intended for further processing before presentation. These are distinguished by their SOP Class UID and by the Enumerated Value of the mandatory Attribute in DX Series Module, Presentation Intent Type (0008,0068).

Within a 3D exam, the MG Image IOD is used to describe the acquired source images: Projections. Each projection is stored as Digital Image For Processing that can be distinguished by its SOP Class UID and the mandatory attribute Image type (0008,0008).

4-3 MG Entity-Relationship Model

The Entity-Relationship diagram for the MG Image interoperability schema is shown in [Illustration 7](#). In this figure, the following diagrammatic convention is established to represent the information organization:

- each entity is represented by a rectangular box.
- each relationship is represented by a diamond shaped box.
- the fact that a relationship exists between two entities is depicted by lines connecting the corresponding entity boxes to the relationship boxes.

The relationships are fully defined with the maximum number of possible entities in the relationship shown. In other words, the relationship between Series and Image can have up to n Images per Series, but the Patient to Study relationship has 1 Patient for each Study (a Patient can have more than one Study on the system, however each Study will contain all of the information pertaining to that Patient)

Illustration 1 MG Image Entity Relationship Diagram.

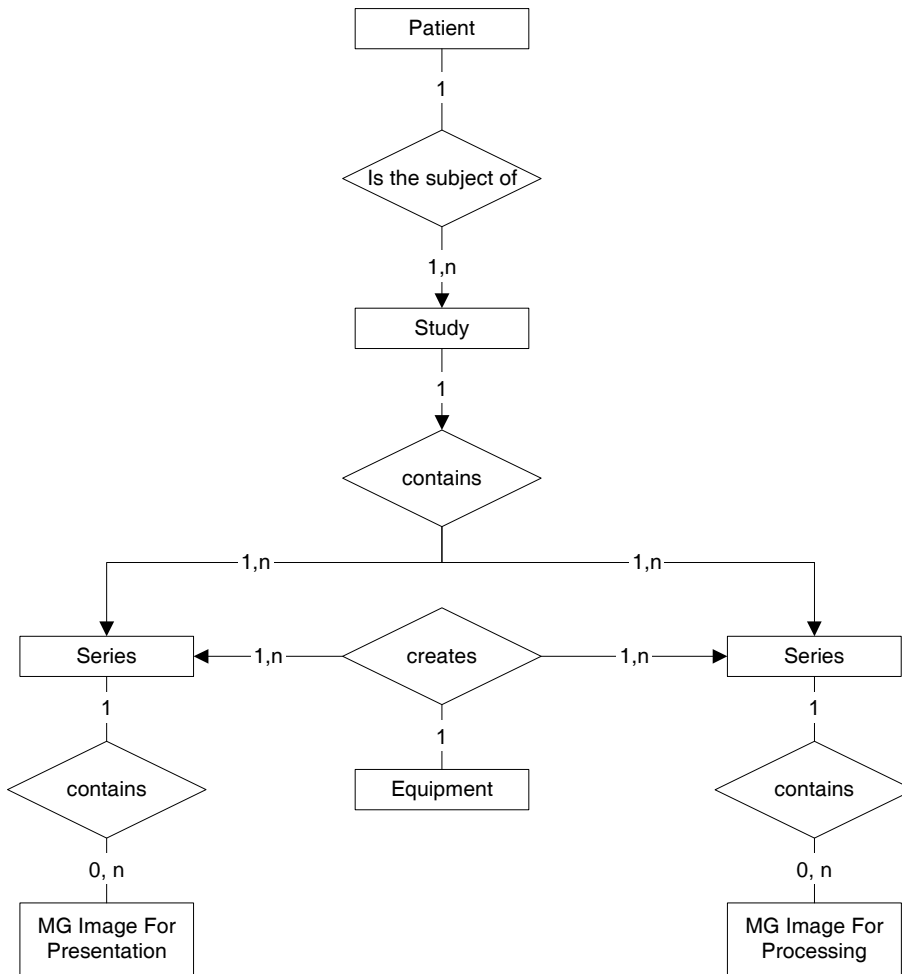

4-3-1 Entity Descriptions

Please refer to DICOM Standard Part 3 (Information Object Definitions) for a description of each of the entities contained within the MG Information Object.

4-3-2 Senographe Essential Acquisition Workstation Mapping of DICOM entities

Table 1 Mapping of DICOM Entities to Senographe Essential AWS Entities

DICOM	Senographe Essential AWS Entity
Patient	Patient
Study	Study
Series	Series
Image	Image
Frame	Frame

4-4 IOD Module Table

Within an entity of the DICOM MG IOD, attributes are grouped into related set of attributes. A set of related attributes is termed a module. A module facilitates the understanding of the semantics concerning the attributes and how the attributes are related with each other. A module grouping does not infer any encoding of information into datasets.

[Table 2 on page 57](#) identifies the defined modules within the entities which comprise the DICOM MG IOD. Modules are identified by Module Name.

See DICOM Part 3.

Table 2 MG Image IOD Modules

Entity Name	Module Name	Usage	Reference
Patient	Patient	Used	4-5-1-1 Patient Module on page 60
Study	General Study	Used	4-5-2-1 General Study Module on page 61
	Patient Study	Used	4-5-2-2 Patient Study Module on page 62
	Series	General Series	Used
	DX Series	Used	4-5-3-2 DX Series Module on page 63
	Mammography Series	Used	4-5-6-14 Mammo Series Module on page 75
	Frame of Reference	Used in stereotactic exam, CEM exam and 3D exam.	4-5-4-1 Frame of reference module on page 64
Equipment	General Equipment	Used	4-5-5-1 General Equipment Module on page 64
Image	General Image Icon Image	Used	4-5-6-1 General Image Module on page 65
	Image Pixel	Used	4-5-6-2 Image Pixel Module on page 67
	Contrast/Bolus Agent	Used in CEM images only	4-5-6-3 Contrast/Bolus Module Attributes on page 68
	Display Shutter	Used for 3D exam images only (i.e. projections)	4-5-6-4 Display Shutter Module Attributes on page 68
	X-Ray Filtration	Used	4-5-6-7 X-Ray Filtration Module on page 71
	X-Ray Acquisition Dose	Used	4-5-6-5 X-Ray Acquisition Dose Modules on page 68
	X-Ray Generation	Used	4-5-6-6 X-Ray Generation Module on page 69
	X-Ray Grid	Used	4-5-6-8 X-Ray Grid Module on page 71

Entity Name	Module Name	Usage	Reference
	DX Anatomy Imaged	Used	4-5-6-9 DX Anatomy Imaged Module on page 71
	DX Image	Used	4-5-6-10 DX Image Module on page 71
	Mammography Image	Used	4-5-6-15 Mammo Image Module on page 76
	DX Detector	Used	4-5-6-11 DX Detector Module on page 73
	X-Ray Collimator	Used when collimation has been applied	4-5-6-12 X-Ray Collimator Module on page 74
	DX Positioning	Used	4-5-6-13 DX Positioning Module on page 74
	Acquisition Context	Used	4-5-6-16 Acquisition Context Module on page 77
	VOI LUT	Used	4-5-6-17 VOI LUT module on page 77
	SOP Common	Used	4-5-6-18 SOP Common Module on page 78
Private Module	Application module	Used when information is available	4-5-7 Application Module (Private Module) on page 78

4-5 Information Module Definitions

Please refer to DICOM Standard Part 3 (Information Object Definitions) for a description of each of the entities and modules contained within the Digital Mammography X-ray Information Object.

The following modules are included to convey Supported Values and Optional Attributes supported. Type 1 & Type 2 Attributes are also included for completeness and to define what values they may take and where these values are obtained from. It should be noted that they are the same ones as defined in the DICOM Standard Part 3 (Information Object Definitions). Attributes not enclosed in the following modules are not generated by the system and are ignored when received from a remote host.

4-5-1 Common Patient Entity Modules

4-5-1-1 Patient Module

This section specifies the Attributes of the Patient that describe and identify the Patient who is the subject of a diagnostic Study. This Module contains Attributes of the patient that are needed for diagnostic interpretation of the Image and are common for all studies performed on the patient.

Table 3 PATIENT MODULE ATTRIBUTES

Attribute Name	Tag	Type	Attribute Description
Patient's Name	(0010,0010)	2	The value is loaded from HIS/RIS or is entered by the user using the Medical Procedure Card.
Patient ID	(0010,0020)	2	The value is loaded from HIS/RIS or is entered by the user using the Medical Procedure Card.
Patient's Birth Date	(0010,0030)	2	The value is loaded from HIS/RIS or is entered by the user using the Medical Procedure Card.
Patient's Sex	(0010,0040)	2	The value is loaded from HIS/RIS or is entered by the user using the Medical Procedure Card.
Referenced Patient Sequence*	(0008,1120)	3	Present if retrieved from the HIS/RIS, not sent otherwise
> Referenced SOP Class UID*	(0008,1150)	1C	Data retrieved from the HIS/RIS
> Referenced SOP Instance UID*	(0008,1155)	1C	Data retrieved from the HIS/RIS
Patient Identity Removed	(0012,0062)	3	Used only in de-identified images with the value "YES"
De-Identification Method	(0012,0063)	1C	Used only in de-identified images with the value "De-identification"
Issuer of Patient ID	(0010,0021)	3	Not Used
Issuer of Patient ID Qualifiers Sequence	(0010,0024)	3	Not Used
>Universal Entity ID	(0040,0032)	3	Not Used
>Universal Entity ID Type	(0040,0033)	1C	Not Used
>Identifier Type Code	(0040,0035)	3	Not Used
Other Patient IDs	(0010,1000)	3	Not Used
Other Patient IDs Sequence	(0010,1002)	3	Not Used
>Type of Patient ID	(0010,0022)	1	Not Used
>Issuer of Patient ID	(0010,0021)	3	Not Used
>>Issuer of Patient ID Qualifiers Sequence	(0010,0024)	3	Not Used
>>Universal Entity ID	(0040,0032)	3	Not Used
>>Universal Entity ID Type	(0040,0033)	1C	Not Used
>>Identifier Type Code	(0040,0035)	3	Not Used

Note: All items marked by an asterisk are present in the generated images only if data has been retrieved from Modality Worklist through the WORKLIST SERVER AE.

4-5-2 Common Study Entity Modules

The following Study IE Modules are common to all Composite Image IODs which reference the Study IE. These Modules contain Attributes of the patient and study that are needed for diagnostic interpretation of the image.

4-5-2-1 General Study Module

This section specifies the Attributes which describe and identify the Study performed upon the Patient.

Table 4 GENERAL STUDY MODULE ATTRIBUTES

Attribute Name	Tag	Type	Attribute Description
Study Date	(0008,0020)	2	The system set it to today's date when generating a new study.
Study Time	(0008,0030)	2	The system set it to current time when generating a new study.
Accession Number	(0008,0050)	2	The value is loaded from HIS/RIS or is entered by the user using the Medical Procedure Card.
Referring Physician's Name	(0008,0090)	2	The value is loaded from HIS/RIS or is entered by the user using the Medical Procedure Card.
Study Description	(0008,1030)	3	The value is loaded from HIS/RIS, using information in Procedure description attribute (0032, 1060), or is entered by the user using the Medical Procedure Card.
Referenced study sequence*	(0008,1110)	3	Data retrieved from the HIS/RIS or attribute is not sent otherwise
> Referenced SOP Class UID*	(0008,1150)	1C	Data retrieved from the HIS/RIS or attribute is not sent otherwise
> Referenced SOP Instance UID*	(0008,1155)	1C	Data retrieved from the HIS/RIS or attribute is not sent otherwise
Study Instance UID	(0020,000D)	1	The value is loaded from HIS/RIS or is generated by the system.
Study ID	(0020,0010)	2	The value is loaded from HIS/RIS, using information in Requested Procedure ID (0040, 1001) or is generated by the system.
Procedure Code Sequence	(0008,1032)	3	Data retrieved from the HIS/RIS or attribute is not sent otherwise
>Code Value	(0008,0100)	1	Data retrieved from the HIS/RIS or attribute is not sent otherwise
>Coding Scheme Designator	(0008,0102)	1	Data retrieved from the HIS/RIS or attribute is not sent otherwise
>Code Meaning	(0008,0104)	1C	Data retrieved from the HIS/RIS or attribute is not sent otherwise

Note:

All items marked by an asterisk are present in the generated images only if data has been retrieved from Modality Worklist through the WORKLIST SERVER AE.

4-5-2-2 Patient Study Module

This section specifies the Attributes which provide information about the patient at the time the study was performed.

Table 5 Patient STUDY MODULE ATTRIBUTES

Attribute Name	Tag	Type	Attribute Description
Patient's age	(0010,1010)	3	The value is generated by the system when the patient's birth date (0010,0030) is provided.

4-5-3 Common Series Entity Modules

The following Series IE Modules are common to all Composite Image IODs which reference the Series IE.

4-5-3-1 General Series Module

This section specifies the Attributes which identify and describe general information about the Series within a Study.

Table 6 GENERAL SERIES MODULE ATTRIBUTES

Attribute Name	Tag	Type	Attribute Description
Modality	(0008,0060)	1	MG = Digital Mammography X-Ray
Series Date	(0008,0021)	3	The system sets it to today's date when generating a new series.
Series Time	(0008,0031)	3	The system sets it to current time when generating a new series.
Performing Physicians' Name	(0008,1050)	3	The value is loaded from HIS/RIS, using information in Scheduled Performing Physician's Name (0040, 0006) or is entered/updated by the user using the Medical Procedure Card.
Protocol Name	(0018,1030)	3	Set to ROUTINE for a routine exam. Set to STEREO for a stereotaxy exam Set to CESH for CESH exam. Set to 3D_ROUTINE for 3D exam.
Series Description	(0008,103E)	3	The value is loaded from HIS/RIS, using information in Scheduled Procedure Step Description (0040, 0007) or is entered by the user using the Medical Procedure Card.
Operators' Name	(0008,1070)	3	The value is entered by the user using the Medical Procedure Card.
Referenced Performed Procedure Step Sequence*	(0008,1111)	3	Uniquely identifies the MPPS SOP instance to which the image is linked
> Referenced SOP Class UID	(0008,1150)	1C	Set to 1.2.840.10008.3.1.2.3.3
> Referenced SOP Instance UID	(0008,1155)	1C	MPPS SOP instance UID generated by the system at acquisition
Body Part Examined	(0018,0015)	3	Set to BREAST

Attribute Name	Tag	Type	Attribute Description
Series Instance UID	(0020,000E)	1	UID is generated by the system.
Series Number	(0020,0011)	2	Number generated by the system
Performed procedure step start date*	(0040,0244)	3	Date on which the exam was started
Performed procedure step start time*	(0040,0245)	3	Time on which the exam was started
Performed procedure step ID*	(0040,0253)	3	Order number automatically generated by the system
Performed procedure step description*	(0040,0254)	3	User entered data or data retrieved from the RIS.
Request Attributes Sequence	(0040,0275)	3	This information is present only if retrieved from HIS/RIS.
>Scheduled Procedure Step Description	(0040,0007)	3	This information is present only if retrieved from HIS/RIS.
>Scheduled Protocol Code Sequence	(0040,0008)	1C	This information is present only if retrieved from HIS/RIS.
>>Code Value	(0008,0100)	1	This information is present only if retrieved from HIS/RIS.
>>Coding Scheme Designator	(0008,0102)	1	This information is present only if retrieved from HIS/RIS.
>>Code Meaning	(0008,0104)	1C	This information is present only if retrieved from HIS/RIS.
>Scheduled Procedure Step ID	(0040,0009)	1C	This information is present only if retrieved from HIS/RIS.
>Requested Procedure ID	(0040,1001)	1C	This information is present only if retrieved from HIS/RIS.

Note:

All items marked by an asterisk are present in the generated images only if they are referenced by an associated MPPS SOP instance.

4-5-3-2 DX Series Module

This Module contains IOD Attributes that describe a Digital X-ray series performed on the patient.

Table 7 DX SERIES MODULE ATTRIBUTES

Attribute Name	Tag	Type	Attribute Description
Modality	(0008,0060)	1	Described in General Series Module
Presentation Intent Type	(0008,0068)	1	Supported Values: FOR PROCESSING in MG For Processing images. FOR PRESENTATION in MG For Presentation images.
Referenced Performed Procedure Step Sequence*	(0008,1111)	1C	Described in General Series Module
> Referenced SOP Class UID	(0008,1150)	1C	Described in General Series Module

Attribute Name	Tag	Type	Attribute Description
> Referenced SOP Instance UID	(0008,1155)	1C	Described in General Series Module

Note:

All items marked by an asterisk are present in the generated images only if they are referenced by an associated MPPS SOP instance.

4-5-4 Frame of reference Entity Modules

The following Frame Of Reference IE Module is common to all Composite Image IODs, which reference the Frame Of Reference IE.

4-5-4-1 Frame of reference module

This section specifies the Attributes necessary to uniquely identify a frame of reference, which insures the spatial relationship of Images within a Series.

The Frame Of Reference module is present in Composite Image IODs generated by the system during stereotactic exams, CESTM exams or 3D exams.

Table 8 Frame of reference module attributes

Attribute Name	Tag	Type	Attribute Description
Frame of Reference UID	(0020,0052)	1	The value is generated by the system for MG image produced during a stereotactic exam, CESTM exam or 3D exam.
Position Reference Indicator	(0020,1040)	2	Empty for MG image produced during a stereotactic, CESTM exam or 3D exam.

4-5-5 Common Equipment Entity Modules

The following Equipment IE Module is common to all Composite Image IODs which reference the Equipment IE.

4-5-5-1 General Equipment Module

This section specifies the Attributes which identify and describe the piece of equipment which produced a Series of Images.

Table 9 GENERAL EQUIPMENT MODULE ATTRIBUTES

Attribute Name	Tag	Type	Attribute Description
Manufacturer	(0008,0070)	2	Value set to GE MEDICAL SYSTEMS
Institution Name	(0008,0080)	3	Value comes from system configuration
Institution Address	(0008,0081)	3	Value comes from system configuration
Station Name	(0008,1010)	3	Set to ADS workstation hostname
Manufacturer's Model Name	(0008,1090)	3	Value set to "Senographe Essential ADS_xx.yy" where xx.yy is the release number of the software that generated the image.
Device Serial Number	(0018,1000)	3	Value is set to either hostId (SB 150) or MAC address (U20) of the ADS workstation.
Software Versions	(0018,1020)	3	Value set to "ADS Application Package VERSION ADS xx.yy" where xx.yy is the release number of the software that generated the image.

Attribute Name	Tag	Type	Attribute Description
Pixel Padding Value	(0028,0120)	1C	Only sent in MG For Presentation images except CESM Recombined images. Value is set to 0.

4-5-6 Common Image Entity Modules

These Image IE Modules are common to all Composite Image IODs which reference the Image IE.

4-5-6-1 General Image Module

This section specifies the Attributes which identify and describe an image within a particular series.

Table 10 GENERAL IMAGE MODULE ATTRIBUTES

Attribute Name	Tag	Type	Attribute Description
Image Type	(0008,0008)	3	Value 1 is set to: ORIGINAL or DERIVED Value 2 is set to: PRIMARY or SECONDARY Value 3 is left EMPTY. Value 4 is set in CESM images to: HIGH_ENERGY, LOW_ENERGY or RECOMBINED Value 4 is set in images acquired during 3D exam to PROJECTION Value 4 is not present otherwise. Note: Even in the case of stereotactic exam value 3 remains empty
Acquisition Date	(0008,0022)	3	Set by the system when acquiring the image
Content Date	(0008,0023)	2C	Set by the system when building the image. Equal to Acquisition Date in MG For Processing image.
Acquisition Time	(0008,0032)	3	Set by the system when acquiring the image
Content Time	(0008,0033)	2C	Set by the system when building the image. Equal to Acquisition Time in MG For Processing image.
Source Image Sequence	(0008,2112)	3	Only described in MG for Presentation Images. Sent with 1 or 2 items.
>Referenced SOP Class UID	(0008,1150)	1C	Always set to 1.2.840.10008.5.1.4.1.1.1.2.1
>Referenced SOP Instance UID	(0008,1155)	1C	In MG For Presentation images: Set to the UID of the IOD from which this For Presentation image has been derived. In CESM Recombined images: contains the UID for the LOW_ENERGY (respectively HIGH_ENERGY) raw image (MG for processing image) that was used to build the RECOMBINED image.
>Spatial Location Preserved	(0028,135A)	3	Always set to YES.
Image Number	(0020,0013)	2	Number generated by the system
Patient Orientation	(0020,0020)	2C	See 4-5-6-1-1-1 Patient Orientation on page 66 .
Images in Acquisition	(0020,1002)	3	Sent for 3D exams only. Value set to the number of Projections.

Attribute Name	Tag	Type	Attribute Description
Quality Control Image	(0028,0300)	3	Always set to NO
Burned In Annotation	(0028,0301)	1	Always set to NO
Lossy Image Compression	(0028,2110)	1	Always set to 00
Icon Image Sequence	(0088,0200)	3	Always sent with one item.
>Samples Per Pixel	(0028,0002)	1C	Always set to 1
>Photometric Interpretation	(0028,0004)	1C	Always set to MONOCHROME2
>Rows	(0028,0010)	1C	Always <= 64
>Columns	(0028,0011)	1C	Always <= 64
>Bits Allocated	(0028,0100)	1C	Always equal to 8
>Bits Stored	(0028,0101)	1C	Always equal to 8
>High Bit	(0028,0102)	1C	Always equal to 7
>Pixel Representation	(0028,0103)	1C	Always equal to 0
>Pixel Data	(7FE0,0010)	1C	Always sent
Presentation LUT Shape	(2050,0020)	3	Described in DX image module

4-5-6-1-1. General Image Attribute Descriptions

4-5-6-1-1-1. Patient Orientation

Patient Orientation is set according to the Clinical View, as describe in the following table:

Clinical View	Patient Orientation (Row orientation \ Column Orientation)
RCC, RXCCM, RXCCL, RXCC	P\L
CV	A\R
LCC, LXCCM, LXCCL, LXCC	A\R
RAT, RMLO, LSIO	P\FL
RFB	P\R
LFB	A\L
LAT, LMLO, RSIO	A\FR
RML, LLM	P\F
LLMO	P\FR
RLMO	A\FL
LML, RLM	A\F

4-5-6-1-1-2. Source Image Sequence

Only in MG for Presentation Image.

- For routine image: Source Image Sequence references the SOP instance UID of the raw image (MG for Processing image) from which the processed image (MG for presentation image) was created.

- For MG RECOMBINED CESM image: Source Image Sequence references the two SOP instance UIDs of the FOR PROCESSING images (HIGH_ENERGY and LOW_ENERGY) from which the image was created.

4-5-6-2 Image Pixel Module

This section specifies the Attributes that describe the pixel data of the image.

Table 11 IMAGE PIXEL MODULE ATTRIBUTES

Attribute Name	Tag	Type	Attribute Description
Samples per Pixel	(0028,0002)	1	Always set to 1
Photometric Interpretation	(0028,0004)	1	Set to MONOCHROME1 in MG For Processing images. Set to MONOCHROME2 in MG For Presentation images.
Rows	(0028,0010)	1	Routine, CESM and 3D exams: set to 2294 or 3062, depending on the Field of View used for acquisition. Stereotactic exam: set to 794 for scout images and 707 for angulated images
Columns	(0028,0011)	1	Routine, CESM and 3D exams: set to 1914 or 2394, depending on the Field of View used for acquisition. Stereotactic exam: set to 990 for scout images and 989 for angulated images
Bits Allocated	(0028,0100)	1	Set to 16
Bits Stored	(0028,0101)	1	Set to 14 for MG for Processing. Set to 12 for MG for Presentation
High Bit	(0028,0102)	1	Set to 13 for MG for Processing. Set to 11 for MG for Presentation
Pixel Representation	(0028,0103)	1	Always set to 0000H (unsigned integer)
Pixel Padding Range Limit	(0028,0121)	1C	Only described in MG For Presentation images. Value is the upper bound of the detected pixels values not containing breast data. Note: Attribute may be absent if no breast border detection occurred in the image creation process (PROC_0 processing code) or if breast border detection failed.
Pixel Data	(7FE0,0010)	1	Always sent

4-5-6-3 Contrast/Bolus Module Attributes

This section specifies the attributes that describe the contrast/bolus used in the acquisition of the image. This module is only present for images acquired during CESM.

Table 12 Contrast/Bolus Module Attributes

Attribute Name	Tag	Type	Attribute Description
Contrast/Bolus Agent	(0018,0010)	2	Contrast or bolus agent used during CESM acquisition. Information selected by user at exam start
Contrast/Bolus Volume	(0018,1041)	3	Volume injected in milliliters of diluted contrast agent: information selected by user at exam start
Contrast/Bolus Ingredient Concentration	(0018,1049)	3	Milligrams of active ingredient per milliliter of (diluted) agent
Contrast/Bolus Start Time	(0018,1042)	3	Time of start of injection: information entered by user at exam start

4-5-6-4 Display Shutter Module Attributes

This section specifies the attributes that describe the Display Shutter used for the image. This module is only present for images acquired during 3D exam (i.e. Projections).

Table 13 DISPLAY SHUTTER MODULE ATTRIBUTES

Attribute Name	Tag	Type	Attribute Description
Shutter Shape	(0018,1600)	1	Sent with value set to POLYGONAL
Vertices of the Polygonal Shutter	(0018,1620)	1C	Sent with one or more row and column pair coordinates
Shutter Presentation Value	(0018,1622)	3	Sent with value set to 0

4-5-6-5 X-Ray Acquisition Dose Modules

This section specifies the Attributes that describe parameters used when acquiring an image.

Table 14 X-Ray Acquisition Dose MODULE ATTRIBUTES

Attribute Name	Tag	Type	Attribute Description
KVP	(0018,0060)	3	Unit: KV (Not present in CESM RECOMBINED images)
Distance Source to Detector	(0018,1110)	3	Described in DX Positioning Module
Distance Source to Patient	(0018,1111)	3	Described in DX Positioning Module
Exposure Time	(0018,1150)	3	Unit: ms (Not present in CESM RECOMBINED images).
X-Ray Tube Current	(0018,1151)	3	Unit: mA (Not present in CESM RECOMBINED images)

Attribute Name	Tag	Type	Attribute Description
Exposure	(0018,1152)	3	Unit: mAs (Not present in CESH RECOMBINED images)
Exposure in μ As	(0018,1153)	3	Unit: μ As (Not present in CESH RECOMBINED images)
Anode Target Material	(0018,1191)	3	Described in X-Ray Generation Module
Body Part Thickness	(0018,11A0)	3	Unit: mm
Relative X-ray Exposure	(0018,1405)	3	Set to exposure Entrance Dose in microGy
Distance Source to Entrance	(0040,0306)	3	Unit: mm
Entrance Dose	(0040,0302)	3	Unit: dGy (Not present in CESH RECOMBINED images)
Comments on Radiation Dose	(0040,0310)	3	Breast glandularity in% (Not present in CESH RECOMBINED images)
Half Value Layer	(0040,0314)	3	Sent in acquired images for 3D exam only (i.e. Projections).
Organ Dose	(0040,0316)	3	Unit: dGy (Not present in CESH RECOMBINED images)
Entrance dose in mGy	(0040,8302)	3	Unit: mGy, decimal value (Not present in CESH RECOMBINED images)
Organ exposed	(0040,0318)	3	Sent with value BREAST

4-5-6-6 X-Ray Generation Module

This section specifies Attributes that describe the X-Ray generation when acquiring the image.

Table 15 X-RAY Generation MODULE ATTRIBUTES

Attribute Name	Tag	Type	Attribute Description
KVP	(0018,0060)	3	Described in X-Ray Acquisition Dose Module (Not present in CESH RECOMBINED images)
Exposure Time	(0018,1150)	3	Described in X-Ray Acquisition Dose Module (Not present in CESH RECOMBINED images)
Exposure	(0018,1152)	3	Described in X-Ray Acquisition Dose Module (Not present in CESH RECOMBINED images)
Focal Spot	(0018,1190)	3	Set to 0.1 or 0.3 (Not present in CESH RECOMBINED images)
Anode Target Material	(0018,1191)	3	Set to MOLYBDENUM or RHODIUM (Not present in CESH RECOMBINED images)
Exposure Control Mode	(0018,7060)	3	Defined Terms: MANUAL AUTOMATIC (Not present in CESH RECOMBINED images)
X-Ray Tube Current	(0018,1151)	3	Described in X-Ray Acquisition Dose Module (Not present in CESH RECOMBINED images)

Attribute Name	Tag	Type	Attribute Description
Exposure in μ As	(0018,1153)	3	Described in X-Ray Acquisition Dose Module (Not present in CESM RECOMBINED images)
Exposure Control Mode Description	(0018,7062)	3	<p>Described in AUTOMATIC and MANUAL but less values are sent when MANUAL MODE.</p> <p>When automatic is sent, this field contains 12 elements:</p> <ul style="list-style-type: none"> - AOP xxx where xxx is the AOP mode used (values are CNT, STD, DOSE or IMPLANT) - RECTANGLE xx mm yy mm aa mm bb mm where xx,yy,aa,bb are the coordinate and size of the AOP cell used for this image - EXP DOSE xx nGy where xx is the detector dose computed for the exposure in nGy - PRE-EXP DOSE xx nGy where xx is the detector dose computed for the pre-exposure in nGy - PRE-EXP THICK xx mm where xx is the computed equivalent thickness based on the pre-exposure shot - PRE-EXP COMPO xx% is the glandularity computed based on the pre-exposure shot - PRE-EXP KV xx is the kV used for the pre-exposure shot - PRE-EXP TRACK xx is the track used for the pre-exposure shot - PRE-EXP FILTER xx is the filter used for the pre-exposure shot - PADDLE xx indicates if a paddle has been detected in the FOV (if any) - FLATFIELD xx indicates if the image has been treated like a flat field image. - SUPPORT xx is the breast support type <p>Additional values are present in the 3D exam images (i.e. projections):</p> <ul style="list-style-type: none"> - DGN0 xx indicates, for the 0-degree projection, the ratio between Average Glandular Dose and Entrance Skin Exposure. - PRE-EXP DGN xx is the pre-exposure ratio between Average Glandular Dose and Entrance Skin Exposure. - PRE-EXP AGD xx is the pre-exposure average glandular dose in nGy
Exposure Status	(0018,7064)	3	<p>Defined Terms:</p> <p>NORMAL</p> <p>ABORTED</p>

4-5-6-7 X-Ray Filtration Module

This section specifies the Attributes that describe the filter used during acquisition.

Table 16 X-RAY Filtration MODULE ATTRIBUTES

Attribute Name	Tag	Type	Attribute Description
Filter Type	(0018,1160)	3	Set to STRIP (Not present in CESM RECOMBINED images).
Filter Material	(0018,7050)	3	Set to MOLYBDENUM or RHODIUM or COPPER (Not present in CESM RECOMBINED images).

4-5-6-8 X-Ray Grid Module

This section specifies the Attributes that describe the grid used during acquisition.

Table 17 X-RAY GRID MODULE ATTRIBUTES

Attribute Name	Tag	Type	Attribute Description
Grid	(0018,1166)	3	Value 1: RECIPROCATING Value 2: FOCUSED

4-5-6-9 DX Anatomy Imaged Module

The table in this Section contains IOD Attributes that describe the anatomy contained in a MG IOD.

Table 18 DX ANATOMY IMAGED MODULE ATTRIBUTES

Attribute Name	Tag	Type	Attribute Description
Anatomic Region Sequence	(0008,2218)	2	Always sent
>Code Value	(0008,0100)	1C	Used Code: T-04000 for Breast
>Coding Scheme Designator	(0008,0102)	1C	Set to SRT in projections Set to SNM3 otherwise
>Code Meaning	(0008,0104)	1C	Set to Breast
Image Laterality	(0020,0062)	1	Supported Values: R = right L = left B = both

4-5-6-10 DX Image Module

The table in this Section contains IOD Attributes that describe a DX image by specializing Attributes of the General Image and Image Pixel Modules, and adding additional attributes.

Table 19 DX IMAGE MODULE ATTRIBUTES

Attribute Name	Tag	Type	Attribute Description
Samples Per Pixel	(0028,0002)	1	Described in Image Pixel module
Photometric Interpretation	(0028,0004)	1	Described in Image Pixel module
Rows	(0028,0010)	1	Described in Image Pixel module
Columns	(0028,0011)	1	Described in Image Pixel module
Bits Allocated	(0028,0100)	1	Described in Image Pixel module

Attribute Name	Tag	Type	Attribute Description
Bits Stored	(0028,0101)	1	Described in Image Pixel module
High Bit	(0028,0102)	1	Described in Image Pixel module
Image Type	(0008,0008)	1	Described in General Image Module
Acquisition Device Processing Description	(0018,1400)	3	Described only in MG For Presentation Images. Set to PROC_0, PROC_1, PROC_4, PREMIUM_VIEW, CESH_RECUMB.
Acquisition Device Processing Code	(0018,1401)	3	Described only in MG for Presentation Images. GEMS_FFDM_PV, GEMS_FFDM_MTAC_1, GEMS_FFDM_TC_1, GEMS_FFDM_AC_1, GEMS_CESH_1.
Patient Orientation	(0020, 0020)	1C	Described in General Image Module
Pixel Representation	(0028,0103)	1	Described in Image Pixel module
Burned In Annotation	(0028,0301)	1	Described in General Image Module
Pixel Intensity Relationship	(0028,1040)	1	Set to LIN in MG For Processing images. Set to LOG in MG For Presentation images.
Pixel Intensity Relationship Sign	(0028,1041)	1	Set to +1 in MG For Processing images. Set to -1 in MG For Presentation images.
Window Center	(0028,1050)	1C	Described in VOI LUT Module
Window Width	(0028,1051)	1C	Described in VOI LUT Module
Rescale Intercept	(0028,1052)	1	Always set to 0.
Rescale Slope	(0028,1053)	1	Always set to 1.
Rescale Type	(0028,1054)	1	Always set to US.
Window Center and Width Explanation	(0028,1055)	3	Described in VOI LUT Module
Presentation LUT Shape	(2050,0020)	1	Set to INVERSE in MG For Processing images. Set to IDENTITY in MG For Presentation images.
Lossy Image Compression	(0028,2110)	1	Described in General Image Module
VOI LUT Sequence	(0028,3010)	3	Described in VOI LUT Module

4-5-6-11 DX Detector Module

The table in this Section contains IOD Attributes that describe a DX detector.

Table 20 DX Detector Module Attributes

Attribute Name	Tag	Type	Attribute Description
Field of View Shape	(0018,1147)	3	Set to RECTANGLE
Field of View Dimensions	(0018,1149)	3	Value 1 set to row dimension in mm. Value 2 set to column dimension in mm.
Sensitivity	(0018,6000)	3	Detector Sensitivity in manufacturer specific units.
Detector Conditions Nominal Flag	(0018,7000)	3	Supported Values: YES NO
Detector Temperature	(0018,7001)	3	Sent if available
Detector Type	(0018,7004)	2	Set to SCINTILLATOR
Detector Configuration	(0018,7005)	3	Set to AREA
Detector Description	(0018,7006)	3	Conveys the detector version and the version of the processing applied to the row image.
Detector ID	(0018,700A)	3	The ID or serial number of the detector used to acquire this image.
Date of Last Detector Calibration	(0018,700C)	3	Date on which the last bad pixel map has been performed on the system.
Time of Last Detector Calibration	(0018,700E)	3	Time on which the last bad pixel map has been performed on the system.
Detector Element Physical Size	(0018,7020)	3	set to 0.1\0.1
Detector Element Spacing	(0018, 7022)	3	Row dimension and column dimension set to 0.1
Detector Active Shape	(0018,7024)	3	Set to RECTANGLE
Detector Active Dimensions	(0018,7026)	3	Value 1 is set to row dimension in mm. Value 2 is set to column dimension in mm.
Field of View origin	(0018,7030)	1C	Sent if Field of View Rotation or Field of View Horizontal Flip is sent. Always sent in 3D exam with value set to 5.0\1.0
Field of View Rotation	(0018, 7032)	1C	Set to value of clockwise rotation in degrees of Field of View related to the physical detector. Sent if Field of View Horizontal Flip is sent.
Field of View Horizontal Flip	(0018, 7034)	1C	Supported Values: YES NO Sent if Field of View Rotation is sent.
Detector Binning	(0018,701A)	3	Set to 1.0\1.0
Imager Pixel Spacing	(0018,1164)	1	Set to 0.1\0.1

4-5-6-12 X-Ray Collimator Module

X-Ray Collimator module is optional and it is sent only if collimation has been applied while acquiring the image.

The table in this Section contains IOD Attributes that describe the collimation applied while acquiring the MG image.

Table 21 X-RAY COLLIMATOR MODULE ATTRIBUTES

Attribute Name	Tag	Type	Attribute Description
Collimator Shape	(0018,1700)	1	Set to RECTANGULAR.
Collimator Left Vertical Edge	(0018,1702)	1C	Sent if Collimator shape is sent.
Collimator Right Vertical Edge	(0018,1704)	1C	Sent if Collimator shape is sent.
Collimator Upper Horizontal Edge	(0018,1706)	1C	Sent if Collimator shape is sent.
Collimator Lower Horizontal Edge	(0018,1708)	1C	Sent if Collimator shape is sent.

4-5-6-13 DX Positioning Module

The table in this Section contains IOD Attributes that describe the positioning used in acquiring the MG image.

Table 22 DX POSITIONING MODULE ATTRIBUTES

Attribute Name	Tag	Type	Attribute Description
Distance Source to Detector	(0018,1110)	3	Distance in mm from the source to the image plane.
Distance Source to Patient	(0018,1111)	3	Implementation limitation: In magnification mode, the value is equal to the distance in mm from the source to the theoretical average breast height (e.g. 20 mm above the breast support) In contact mode, the value is equal to the distance in mm from the source to the detector plane. The Estimated Radiographic Magnification factor (0018,1114) and the Distance Source to Entrance (0040,0306) are computed based on the Distance Source to Patient (0018,1111).
Estimated Radiographic Magnification Factor	(0018,1114)	3	Set to 1, 1.5 or 1.8
Body Part Thickness	(0018,11A0)	3	Described in X-ray Acquisition Dose Module
Compression Force	(0018,11A2)	3	unit: Newton
Positioner Type	(0018, 1508)	1	Set to MAMMOGRAPHIC
Positioner Primary Angle	(0018,1510)	3	Position in degrees of the X-Ray beam vector in the coronal anatomical plane as if the patient were standing where movement of the X-Ray source from right to vertical is positive, and vertical is zero.
Detector Secondary Angle	(0018,1531)	3	Set to X-ray beam angle relative to the normal to the detector plane in degrees.
View Position	(0018,5101)	3	Set to ACR BI-RADS Equivalent of View Code. See Table 29 on page 82

Attribute Name	Tag	Type	Attribute Description
View Code Sequence	(0054,0220)	1	One item is described in this sequence.
> Code Value	(0008,0100)	1	See list of view codes in Table 29 on page 82
> Code Scheme descriptor	(0008,0102)	1	Set to SRT in projections. Set to SNM3 otherwise.
> Code Meaning	(0008,0104)	1	See list of view code meaning in Table 29 on page 82
>View Modifier Code Sequence	(0054,0222)	2	Zero or more items can be described in this sequence
>> Code Value	(0008,0100)	1C	See list of view modifier codes in Table 30 on page 82
>> Code Scheme descriptor	(0008,0102)	1C	Set to SNM3 or SRT depending on system configuration
>> Code Meaning	(0008,0104)	1C	See list of view modifier code meaning in Table 30 on page 82 .
Paddle Description	(0018,11A4)	3	Describes the used paddle. When no paddle is used, value is set to "PADDLE not detected".

4-5-6-14 Mammo Series Module

The table in this Section contains IOD Attributes that describe the mammo series.

Table 23 Mammo Series MODULE ATTRIBUTES

Attribute Name	Tag	Type	Attribute Description
Modality	(0008,0060)	1	Described in General Series Module
Request Attributes Sequence	(0040,0275)	3	Described in general series module
>Scheduled Procedure Step Description	(0040,0007)	3	Described in general series module
>Scheduled Protocol Code Sequence	(0040,0008)	1C	Described in general series module
>Scheduled Procedure Step ID	(0040,0009)	1C	Described in general series module
>Requested Procedure ID	(0040,1001)	1C	Described in general series module

4-5-6-15 Mammo Image Module

The table in this Section contains IOD Attributes that describe the mammo image.

Table 24 Mammo Image MODULE ATTRIBUTES

Attribute Name	Tag	Type	Attribute Description
Anatomic Region Sequence	(0008,2218)	1	Described in DX Anatomy Imaged Module
>Code Value	(0008,0100)	1C	Described in DX Anatomy Imaged Module
>Coding Scheme Designator	(0008,0102)	1C	Described in DX Anatomy Imaged Module
>Code Meaning	(0008,0104)	1C	Described in DX Anatomy Imaged Module
Positioner Primary Angle	(0018,1510)	1	Described in DX Positioning Module
Positioner Type	(0018,1508)	1	Described in DX Positioning Module
Image Laterality	(0020,0062)	1	Described in DX Anatomy Imaged Module
Implant Present	(0028,1300)	3	Indicates whether or not the patient has implants. Value set to YES or NO depending on the user entered data into the application.
Organ Exposed	(0040,0318)	1	Described in X-Ray Acquisition Dose Module
View Code Sequence	(0054,0220)	1	Described in DX Positioning Module
> Code Value	(0008,0100)	1	Described in DX Positioning Module
> Code Scheme descriptor	(0008,0102)	1	Described in DX Positioning Module
> Code Meaning	(0008,0104)	1	Described in DX Positioning Module
>View Modifier Code Sequence	(0054,0222)	2	Described in DX Positioning Module
>> Code Value	(0008,0100)	1C	Described in DX Positioning Module
>> Code Scheme descriptor	(0008,0102)	1C	Described in DX Positioning Module
>> Code Meaning	(0008,0104)	1C	Described in DX Positioning Module
Image Type	(0008,0008)	3	Described in General Image Module
Distance Source to Detector	(0018,1110)	3	Described in DX Positioning Module
Distance Source to Patient	(0018,1111)	3	Described in DX Positioning Module

4-5-6-16 Acquisition Context Module

The table in this Section contains IOD Attributes that describe the acquisition context while acquiring the MG image. ACQUISITION CONTEXT MODULE ATTRIBUTES

Attribute Name	Tag	Type	Attribute Description
Acquisition Context Sequence	(0040,0555)	2	Zero length value is sent

4-5-6-17 VOI LUT module

The table in this Section contains IOD Attributes that describe the VOI LUT.

Table 25 VOI LUT MODULE ATTRIBUTES

Attribute Name	Tag	Type	Attribute Description
Window Center	(0028,1050)	1C	Sent only in MG For Presentation Images. Up to four values are present. The fourth value is present only when the user manually changes the brightness/contrast or when the auto contrast is applied by the system. Implementation limitation: the Window Center (0028,1050) and the Window Width (0028,1051) are set for an optimized review with a sigmoid VOI LUT.
Window Width	(0028,1051)	1C	Sent only in MG For Presentation Images. Up to four values are present. The fourth value is present only when the user changes manually changes the brightness/contrast or when the auto contrast is applied by the system. Implementation limitation: the Window Center (0028,1050) and the Window Width (0028,1051) are set for an optimized review with a sigmoid VOI LUT.
Window Center & Width Explanation	(0028,1055)	3	Sent only in MG For Presentation Images Up to four values are present. (NORMAL, SOFTER, HARDER, USER)
VOI LUT Function	(0028,1056)	3	Sent only in MG For Presentation images. One value is always present and set to SIGMOID. Note: This attribute is to indicate that the window center 0018,1050 and window width 0018,1051 attributes are set for an optimized review with a sigmoid VOI LUT. Refer to DICOM Part 3 for the function formula.
VOI LUT Sequence	(0028,3010)	3	Sent only in MG for Presentation images. Up to 4 items are present in its sequence. The fourth value is present only when the user changes (by adjusting sliders) the brightness/contrast, or when the auto contrast is applied by the system.
>LUT Descriptor	(0028,3002)	1C	Sent only in MG for Presentation images
>LUT Explanation	(0028,3003)	3	Sent only in MG for Presentation images
>LUT Data	(0028,3006)	1C	Sent only in MG for Presentation images

4-5-6-18 SOP Common Module

The table in this Section contains IOD attributes for SOP Common Module.

Table 26 SOP COMMON MODULE ATTRIBUTES

Attribute Name	Tag	Type	Attribute Description
Specific Character Set	(0008,0005)	1C	Set to ISO_IR 100 = Latin Alphabet No. 1
SOP Class UID	(0008,0016)	1	Values are: 1.2.840.10008.5.1.4.1.1.1.2.1 1.2.840.10008.5.1.4.1.1.1.2
SOP Instance UID	(0008,0018)	1	UID is generated by the system

4-5-7 Application Module (Private Module)

Application Module is a private module.

The table in this Section contains Attributes that describe various information required by the Senographe Essential Acquisition Workstation Medical Application.

Table 27 APPLICATION MODULE ATTRIBUTES

Attribute Name	Tag	Type	Attribute Description
Private Creator	(0045,0010)	3	Value = GEMS_SENO_02
Stereo angle	(0045,1006)	3	Used to store the theoretical angle (-15°, 0° or 15°) of the X-ray beam in the column direction in degree relative to the normal to the detector plane
Clinical View	(0045,101b)	3	Used to store Clinical View to be displayed on the image.
Estimated Anat mean	(0045,1020)	3	Used to store the Estimated Anatomical Mean.
MAO Buffer	(0045,1026)	3	Used to store annotations added by user, such as graphics or text.
Set Number	(0045,1027)	3	Sent only in stereotaxy images. Used to store set number information
Windowing parameters	(0045,1029)	3	Used to store windowing parameters.
2DLocX	(0045,102a)	3	Used to store X coordinates of the cross-hair cursor
2DLocY	(0045,102b)	3	Used to store Y coordinates of the cross-hair cursor
Radiological Thickness	(0045,1049)	3	Used to store radiological thickness in mms.
SC Instance UID	(0045,1050)	3	UID to be set in SOP Instance UID of SC object created by SC fallback.
SC series UID	(0045,1051)	3	UID to be set in Series Instance UID of SC object created by SC fallback.
mu	(0045,1058)	3	Sent only in MG For Presentation Images. Used to store processing Algorithm parameters (Not present in CESM RECOMBINED images).
Threshold	(0045,1059)	3	Sent only in MG For Presentation Images. Used to store processing Algorithm parameters (Not present in CESM RECOMBINED images).
Breast ROI X	(0045,1060)	3	Sent only in MG For Presentation Images. Used to store Breast ROI x coordinates. (top_left, top_right, bottom_right, bottom_left).
Breast ROI Y	(0045,1061)	3	Sent only in MG For Presentation Images. Used to store Breast ROI y coordinates (top_left, top_right, bottom_right, bottom_left).
Segm Threshold	(0045,1064)	3	Sent only in MG For Processing Images. Used to store processing Algorithm parameters (Not present in CESM RECOMBINED images).
STX buffer	(0045,1071)	3	Used to store stereotaxy puncture information.
Image Crop point	(0045,1072)	3	Used to store the offset in pixels of the top-left-hand-corner of the cropped image to the top-left-hand-corner of the detector area after rotating the image for display.

Attribute Name	Tag	Type	Attribute Description
Premium View Beta	(0045,1090)	3	Sent only in MG for presentation images if Premium View has been applied (Not present in CESM RECOMBINED images).
Signal Average Factor	(0045,10A0)	3	Attribute Description: only sent in CESM LOW_ENERGY and HIGH_ENERGY raw images (MG for Processing images)
Organ Dose for source images	(0045,10A1)	3	Unit: dGy List of values, only present for CESM RECOMBINED images
Entrance dose in mGy for source images	(0045,10A2)	3	Unit: mGy, decimal value List of values, only present for CESM RECOMBINED images
Organ Dose in dGy for the complete DBT sequence	(0045,10A4)	3	Unit: dGy Sent only for images created during 3D exam (i.e. projections)
Entrance Dose in dGy for the complete DBT sequence	(0045,10A8)	3	Unit: dGy Sent only for images created during 3D exam (i.e. projections)

4-6 Private Data Dictionary

The table in this section describes the Private Attributes contained in MG images.

Table 28 Private Creator Identification (GEMS_SENO_02)

Attribute Name	Tag	VR	VM
Stereo angle	(0045,yy06)	DS	1
Clinical View	(0045,yy1b)	LO	1
Estimated Anat mean	(0045,yy20)	DS	1
MAO Buffer	(0045,yy26)	OB	1
Set Number	(0045,yy27)	IS	1
Windowing parameters	(0045,yy29)	DS	2
2DLocX	(0045,yy2a)	IS	1
2DLocY	(0045,yy2b)	IS	1
Radiological Thickness	(0045,yy49)	DS	1
SC Instance UID	(0045,yy50)	UI	1
SC series UID	(0045,yy51)	UI	1
mu	(0045,yy58)	DS	1
Threshold	(0045,yy59)	IS	1
Breast ROI X	(0045,yy60)	IS	4
Breast ROI Y	(0045,yy61)	IS	4
Segm Threshold	(0045,yy64)	IS	1
STX buffer	(0045,yy71)	OB	1
Image Crop point	(0045,yy72)	DS	2
Premium View beta	(0045,yy90)	ST	1
Signal Average Factor	(0045,yyA0)	DS	1
Organ Dose for source images	(0045,yyA1)	DS	2-n
Entrance dose in mGy for source images	(0045,yyA2)	DS	2-n
Organ Dose in dGy for the complete DBT sequence	(0045,yyA4)	DS	1
Entrance Dose in dGy for the complete DBT sequence	(0045,yyA8)	DS	1

4-7 Mammography View Codes

The following table lists View codes defined for Mammo images

Table 29 Mammography View Codes

Code Value (0008,0100)	Code Meaning (0008,0104)	ACR BI-RADS Equivalent
R-10224	medio-lateral	ML
R-10226	medio-lateral oblique	MLO
R-10228	latero-medial	LM
R-10230	latero-medial oblique	LMO
R-10242	cranio-caudal	CC
R-10244	caudo-cranial (from below)	FB
R-102D0	superolateral to inferomedial oblique	SIO
Y-X1770 or R-1024A (depending on system configuration)	cranio-caudal exaggerated laterally	XCCL
Y-X1771 or R-1024B (depending on system configuration)	cranio-caudal exaggerated medially	XCCM

The following table lists View Modifier codes defined for Mammo images:

Table 30 Mammography View Modifier Codes

Code Value (0008,0100)	Code Meaning (0008,0104)	Applies only when view is:	ACR BI-RADS Equivalent
R-102D2	Cleavage	CC or FB	CV
R-102D1	Axillary Tail	MLO	AT
R-102D3	Rolled Lateral	any	...RL
R-102D4	Rolled Medial	any	...RM
R-102D5	Implant Displaced	any	...ID
R-102D6	Magnification	any	M...
R-102D7	Spot Compression	any	...S
R-102C2	Tangential	any	...TAN

4-8 Limitations summary

Module Name	Attribute Name	Tag	Type	Attribute Description
DX Detector	Distance Source to Patient	(0018,1111)	3	<p>Implementation limitation: In magnification mode, the value is equal to the distance in mm from the source to the theoretical average breast height (e.g. 20 mm above the breast support) In contact mode, the value is equal to the distance in mm from the source to the detector plane.</p> <p>The Estimated Radiographic Magnification factor (0018,1114) and the Distance Source to Entrance (0040,0306) are computed based on the Distance Source to Patient (0018,1111).</p>
VOI LUT	Window Center	(0028,1050)	1C	<p>Sent only in MG For Presentation Images. Up to four values are present. The fourth value is present only when the user manually changes the brightness/contrast or when the auto contrast is applied by the system. Note that proper rendering of the images requires support of 0028, 1056 VOI LUT function set to SIGMOID (see DICOM standard part 3 for further details).</p>
VOI LUT	Window Width	(0028,1051)	1C	<p>Sent only in MG For Presentation Images. Up to four values are present. The fourth value is present only when the user manually changes the brightness/contrast or when the auto contrast is applied by the system. Note that proper rendering of the images requires support of 0028, 1056 VOI LUT function set to SIGMOID (see DICOM standard part 3 for further details).</p>
Image Module	Image Type	(0008,0008)		<p>Implementation limitation: In stereotactic exam, value 3 is empty. The proper values are described in DICOM standard part 3 section C.8.11.7.1.4</p>

Note:

If SOP instances which are missing the private elements defined in section [4-5-7 Application Module \(Private Module\) on page 78](#) (i.e. transferred back from a level 1 storage SCP), the review application of the Senographe Essential might not start.

This page is intentionally left blank.

5 Breast Tomosynthesis Image Information Object Implementation

5-1 Introduction

This section specifies the use of the DICOM Breast Tomosynthesis Image IOD to represent the information included in Breast Tomosynthesis images produced by this implementation using MG images created during 3D exam with this implementation. Corresponding attributes are conveyed using the module construct.

The contents of this section are:

[5-2 Breast Tomosynthesis IOD Implementation on page 85](#)

[5-3 Breast Tomosynthesis Entity-Relationship Model on page 85](#)

[5-4 IOD Module Table on page 87](#)

[5-6 Information Module Definitions on page 89](#)

[5-7 Private Data Dictionary on page 106](#)

5-2 Breast Tomosynthesis IOD Implementation

The Breast Tomosynthesis Image IOD is used for Storage Service, a SOP Class for storage of Breast Tomosynthesis images defined in PS3.4.

Breast Tomosynthesis image is reconstructed from a set of acquired source images that we call Projections. We distinguish two types of Breast Tomosynthesis images:

Planes: where image is defined by a series of parallel tomographic planes.

Slabs: where image is defined by a series of slabs resulting from the combination of several planes.

5-3 Breast Tomosynthesis Entity-Relationship Model

The Entity-Relationship diagram for the Breast Tomosynthesis Image interoperability schema is shown in [Illustration 1](#). In this figure, the following diagrammatic convention is established to represent the information organization:

- each entity is represented by a rectangular box.
- each relationship is represented by a diamond shaped box.
- the fact that a relationship exists between two entities is depicted by lines connecting the corresponding entity boxes to the relationship boxes.

The relationships are fully defined with the maximum number of possible entities in the relationship shown. In other words, the relationship between Series and Image can have up to n Images per Series, but the Patient to Study relationship has 1 Patient for each Study (a Patient can have more than one Study on the system, however each Study will contain all of the information pertaining to that Patient)

Illustration 1 Breast Tomosynthesis Image Entity Relationship Diagram.

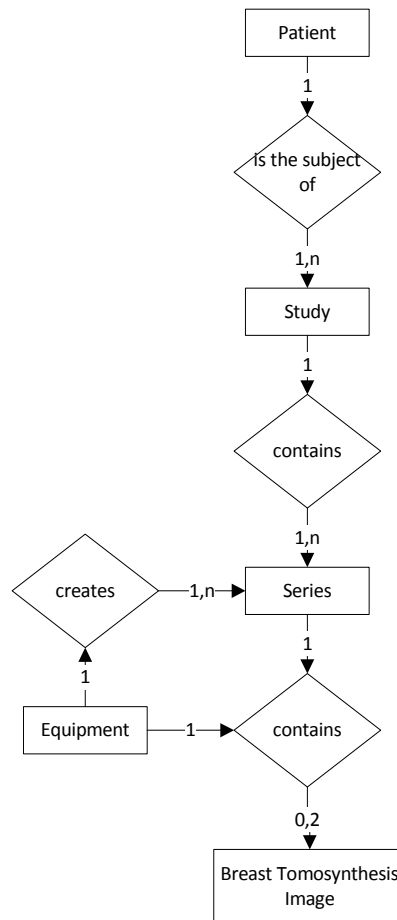

5-3-1 Entity Descriptions

Please refer to DICOM Standard Part 3 (Information Object Definitions) for a description of each of the entities contained within the Breast Tomosynthesis Image Information Object.

5-3-2 Senographe Essential Acquisition Workstation Mapping of DICOM entities

Table 1 Mapping of DICOM Entities to Senographe Essential AWS Entities

DICOM	Senographe Essential AWS Entity
Patient	Patient
Study	Study
Series	Series
Image	Image
Frame	Frame

5-4 IOD Module Table

Within an entity of the DICOM Breast Tomosynthesis Image IOD, attributes are grouped into related set of attributes. A set of related attributes is termed a module. A module facilitates the understanding of the semantics concerning the attributes and how the attributes are related with each other. A module grouping does not infer any encoding of information into datasets.

[Table 2 on page 87](#) identifies the defined modules within the entities which comprise the DICOM Breast Tomosynthesis IOD. Modules are identified by Module Name.

See DICOM Part 3.

Table 2 Breast Tomosynthesis Image IOD Modules

Entity Name	Module Name	Usage	Reference
Patient	Patient	Used	5-6-1-1 Patient Module on page 89
	Clinical Trial Subject	Not used	
Study	General Study	Used	5-6-2-1 General Study Module on page 90
	Patient Study	Used	5-6-2-2 Patient Study Module on page 91
	Clinical Trial Study	Not used	
Series	General Series	Used	5-6-3-1 General Series Module on page 91
	Clinical Trial Series	Not used	
	Enhanced Mammography Series	Used	5-6-3-2 Enhanced mammography Series Module on page 93
Frame of Reference	Frame of Reference	Used	5-6-4-1 Frame of reference module on page 93
	Synchronization	Not used	
Equipment	General Equipment	Used	5-6-5-1 General Equipment Module on page 93
	Enhanced General Equipment	Used	5-6-5-2 Enhanced General Equipment Module on page 94
Image	Image Pixel	Used	5-6-6-1 Image Pixel Module on page 94
	Enhanced Contrast/Bolus	Not used	
	Device	Not used	
	Intervention	Not used	
	Acquisition Context	Used	5-6-6-2 Acquisition Context Module on page 94
	Multi-frame Functional Groups	Used	5-6-6-3 Multi-frame Functional Groups Module on page 96
	Multi-frame Dimension Module	Not used	
	Image - Equipment Coordinate Relationship	Not used	
	Specimen	Not used	
	X-Ray 3D Image	Used	5-6-6-4 X-Ray 3D Image Module on page 98

Entity Name	Module Name	Usage	Reference
	Breast Tomosynthesis Contributing Sources	Used	5-6-6-5 Breast Tomosynthesis Contributing Sources Module on page 99
	Breast Tomosynthesis Acquisition	Used	5-6-6-6 Breast Tomosynthesis Acquisition Module on page 101
	X-Ray 3D Reconstruction	Used	5-6-6-7 X-Ray 3D Reconstruction Module on page 104
	Breast View	Used	5-6-6-8 Breast View Module on page 104
	SOP Common	Used	5-6-6-9 SOP Common Module on page 105
	Frame Extraction	Not used	
Private Module	Application module	Used when information is available	5-6-7 Application Module (Private Module) on page 105

5-5 Breast Tomosynthesis Image Functional Group Macros

[Table 3 on page 88](#) specifies the use of the Functional Group macros used in the Multi-frame Functional Groups Module for the Breast Tomosynthesis Image IOD.

Table 3 Breast Tomosynthesis Image IOD Modules

Functional Group Macro	Usage
Pixel Measures	Used as a Shared Functional Group
Frame Content	Used as a Per-frame Functional Group
Plane Position (Patient)	Used as a Per-frame Functional Group
Plane Orientation (Patient)	Used as a Shared Functional Group
Referenced Image	Not Used
Derivation Image	Used as a Shared Functional Group for Slabs Used as a Shared Functional Group for Planes when Lossy Compression is applied. Not used otherwise.
Frame Anatomy	Used as a Shared Functional Group
Identity Pixel Value Transformation	Used as a Shared Functional Group
Frame VOI LUT With LUT	Used as a Shared Functional Group
Real Word Value Mapping	Not Used
Contrast/Bolus Usage	Not Sent
X-Ray 3D Frame Type	Used as a Per-frame Functional Group

5-6 Information Module Definitions

Please refer to DICOM Standard Part 3 (Information Object Definitions) for a description of each of the entities and modules contained within the Breast Tomosynthesis Image Information Object.

The following modules are included to convey Supported Values and Optional Attributes supported. Type 1 & Type 2 Attributes are also included for completeness and to define what values they may take and where these values are obtained from. It should be noted that they are the same ones as defined in the DICOM Standard Part 3 (Information Object Definitions). Attributes not enclosed in the following modules are not generated by the system and are ignored when received from a remote host.

5-6-1 Common Patient Entity Modules

5-6-1-1 Patient Module

This section specifies the Attributes of the Patient that describe and identify the Patient who is the subject of a diagnostic Study. This Module contains Attributes of the patient that are needed for diagnostic interpretation of the Image and are common for all studies performed on the patient.

Table 4 PATIENT MODULE ATTRIBUTES

Attribute Name	Tag	Type	Attribute Description
Patient's Name	(0010,0010)	2	The value is loaded from HIS/RIS or is entered by the user using the Medical Procedure Card.
Patient ID	(0010,0020)	2	The value is loaded from HIS/RIS or is entered by the user using the Medical Procedure Card.
Patient's Birth Date	(0010,0030)	2	The value is loaded from HIS/RIS or is entered by the user using the Medical Procedure Card.
Patient's Sex	(0010,0040)	2	The value is loaded from HIS/RIS or is entered by the user using the Medical Procedure Card.
Referenced Patient Sequence*	(0008,1120)	3	Present if retrieved from the HIS/RIS, not sent otherwise
> Referenced SOP Class UID*	(0008,1150)	1C	Data retrieved from the HIS/RIS
> Referenced SOP Instance UID*	(0008,1155)	1C	Data retrieved from the HIS/RIS
Issuer of Patient ID	(0010,0021)	3	Not Used
Issuer of Patient ID Qualifiers Sequence	(0010,0024)	3	Not Used
>Universal Entity ID	(0040,0032)	3	Not Used
>Universal Entity ID Type	(0040,0033)	1C	Not Used
>Identifier Type Code	(0040,0035)	3	Not Used
Other Patient IDs	(0010,1000)	3	Not Used
Other Patient IDs Sequence	(0010,1002)	3	Not Used
>Type of Patient ID	(0010,0022)	1	Not Used
>Issuer of Patient ID	(0010,0021)	3	Not Used
>>Issuer of Patient ID Qualifiers Sequence	(0010,0024)	3	Not Used

Attribute Name	Tag	Type	Attribute Description
>>Universal Entity ID	(0040,0032)	3	Not Used
>>Universal Entity ID Type	(0040,0033)	1C	Not Used
>>Identifier Type Code	(0040,0035)	3	Not Used
Patient Identity Removed	(0012,0062)	3	Used only in de-identified images with the value "YES"
De-Identification Method	(0012,0063)	1C	Used only in de-identified images with the value "De-identification"

Note:

All items marked by an asterisk are present in the generated images only if data has been retrieved from Modality Worklist through the WORKLIST SERVER AE.

5-6-2 Common Study Entity Modules

The following Study IE Modules are common to all Composite Image IODs which reference the Study IE. These Modules contain Attributes of the patient and study that are needed for diagnostic interpretation of the image.

5-6-2-1 General Study Module

This section specifies the Attributes which describe and identify the Study performed upon the Patient.

Table 5 GENERAL STUDY MODULE ATTRIBUTES

Attribute Name	Tag	Type	Attribute Description
Study Instance UID	(0020,000D)	1	The value is loaded from HIS/RIS or is generated by the system.
Study Date	(0008,0020)	2	The system set it to today's date when generating a new study.
Study Time	(0008,0030)	2	The system set it to current time when generating a new study.
Referring Physician's Name	(0008,0090)	2	The value is loaded from HIS/RIS or is entered by the user using the Medical Procedure Card.
Study ID	(0020,0010)	2	The value is loaded from HIS/RIS, using information in Requested Procedure ID (0040, 1001) or is generated by the system.
Accession Number	(0008,0050)	2	The value is loaded from HIS/RIS or is entered by the user using the Medical Procedure Card.
Study Description	(0008,1030)	3	The value is loaded from HIS/RIS, using information in Procedure description attribute (0032, 1060), or is entered by the user using the Medical Procedure Card.
Referenced study sequence*	(0008,1110)	3	Data retrieved from the HIS/RIS or attribute is not sent otherwise
> Referenced SOP Class UID*	(0008,1150)	1C	Data retrieved from the HIS/RIS or attribute is not sent otherwise
> Referenced SOP Instance UID*	(0008,1155)	1C	Data retrieved from the HIS/RIS or attribute is not sent otherwise

Attribute Name	Tag	Type	Attribute Description
Procedure Code Sequence	(0008,1032)	3	Data retrieved from the HIS/RIS or attribute is not sent otherwise
>Code Value	(0008,0100)	1	Data retrieved from the HIS/RIS or attribute is not sent otherwise
>Coding Scheme Designator	(0008,0102)	1	Data retrieved from the HIS/RIS or attribute is not sent otherwise
>Code Meaning	(0008,0104)	1C	Data retrieved from the HIS/RIS or attribute is not sent otherwise

Note:

All items marked by an asterisk are present in the generated images only if data has been retrieved from Modality Worklist through the WORKLIST SERVER AE.

5-6-2-2 Patient Study Module

This section specifies the Attributes which provide information about the patient at the time the study was performed.

Table 6 Patient STUDY MODULE ATTRIBUTES

Attribute Name	Tag	Type	Attribute Description
Patient's age	(0010,1010)	3	The value is generated by the system when the patient's birth date (0010,0030) is provided.

5-6-3 Common Series Entity Modules

The following Series IE Modules are common to all Composite Image IODs which reference the Series IE.

5-6-3-1 General Series Module

This section specifies the Attributes which identify and describe general information about the Series within a Study.

Table 7 GENERAL SERIES MODULE ATTRIBUTES

Attribute Name	Tag	Type	Attribute Description
Modality	(0008,0060)	1	MG = Digital Mammography X-Ray
Series Instance UID	(0020,000E)	1	UID is generated by the system.
Series Number	(0020,0011)	2	Number generated by the system
Series Date	(0008,0021)	3	The system sets it to today's date when generating a new series.
Series Time	(0008,0031)	3	The system sets it to current time when generating a new series.
Performing Physicians' Name	(0008,1050)	3	The value is loaded from HIS/RIS, using information in Scheduled Performing Physician's Name (0040, 0006) or is entered/updated by the user using the Medical Procedure Card.
Protocol Name	(0018,1030)	3	Set to 3D_ROUTINE

Attribute Name	Tag	Type	Attribute Description
Series Description	(0008,103E)	3	The value is loaded from HIS/RIS, using information in Scheduled Procedure Step Description (0040, 0007) or is entered by the user using the Medical Procedure Card.
Operators' Name	(0008,1070)	3	The value is entered by the user using the Medical Procedure Card.
Referenced Performed Procedure Step Sequence*	(0008,1111)	3	Uniquely identifies the MPPS SOP instance to which the image is linked
> Referenced SOP Class UID	(0008,1150)	1C	Set to 1.2.840.10008.3.1.2.3.3
> Referenced SOP Instance UID	(0008,1155)	1C	MPPS SOP instance UID generated by the system at acquisition
Body Part Examined	(0018,0015)	3	Set to BREAST
Request Attributes Sequence	(0040,0275)	3	This information is present only if retrieved from HIS/RIS.
>Requested Procedure ID	(0040,1001)	1C	This information is present only if retrieved from HIS/RIS.
>Scheduled Procedure Step ID	(0040,0009)	1C	This information is present only if retrieved from HIS/RIS.
>Scheduled Procedure Step Description	(0040,0007)	3	This information is present only if retrieved from HIS/RIS.
>Scheduled Protocol Code Sequence	(0040,0008)	1C	This information is present only if retrieved from HIS/RIS.
>>Code Value	(0008,0100)	1	This information is present only if retrieved from HIS/RIS.
>>Coding Scheme Designator	(0008,0102)	1	This information is present only if retrieved from HIS/RIS.
>>Code Meaning	(0008,0104)	1C	This information is present only if retrieved from HIS/RIS.
Performed procedure step ID*	(0040,0253)	3	Order number automatically generated by the system
Performed procedure step start date*	(0040,0244)	3	Date on which the exam was started
Performed procedure step start time*	(0040,0245)	3	Time on which the exam was started
Performed procedure step description*	(0040,0254)	3	User entered data or data retrieved from the RIS.

Note:

All items marked by an asterisk are present in the generated images only if they are referenced by an associated MPPS SOP instance.

5-6-3-2 Enhanced mammography Series Module

This Module contains IOD Attributes that describe a series performed on the patient for the context of a Breast Tomosynthesis device.

Table 8 ENHANCED MAMMOGRAPHY SERIES MODULE ATTRIBUTES

Attribute Name	Tag	Type	Attribute Description
Modality	(0008,0060)	1	Described in General Series Module
Referenced Performed Procedure Step Sequence*	(0008,1111)	1C	Described in General Series Module
> Referenced SOP Class UID	(0008,1150)	1C	Described in General Series Module
> Referenced SOP Instance UID	(0008,1155)	1C	Described in General Series Module

Note:

All items marked by an asterisk are present in the generated images only if they are referenced by an associated MPPS SOP instance.

5-6-4 Frame of reference Entity Modules

The following Frame Of Reference IE Module is common to all Composite Image IODs, which reference the Frame Of Reference IE.

5-6-4-1 Frame of reference module

This section specifies the Attributes necessary to uniquely identify a frame of reference, which insures the spatial relationship of Images within a Series.

Table 9 Frame of reference module attributes

Attribute Name	Tag	Type	Attribute Description
Frame of Reference UID	(0020,0052)	1	The value is generated by the system.
Position Reference Indicator	(0020,1040)	2	Sent with empty value.

5-6-5 Common Equipment Entity Modules

The following Equipment IE Module is common to all Composite Image IODs which reference the Equipment IE.

5-6-5-1 General Equipment Module

This section specifies the Attributes which identify and describe the piece of equipment which produced a Series of Images.

Table 10 GENERAL EQUIPMENT MODULE ATTRIBUTES

Attribute Name	Tag	Type	Attribute Description
Manufacturer	(0008,0070)	2	Value set to GE MEDICAL SYSTEMS
Institution Name	(0008,0080)	3	Value comes from system configuration
Institution Address	(0008,0081)	3	Value comes from system configuration
Station Name	(0008,1010)	3	Value set to Reconstruction Box hostname

Attribute Name	Tag	Type	Attribute Description
Manufacturer's Model Name	(0008,1090)	3	Value set to "Senographe Essential DBT Reconstruction Box_xx" where xx is the release number of the software the generated the breast tomosynthesis image.
Device Serial Number	(0018,1000)	3	Value is set to either hostId (SB 150) or MAC address (U20) of the ADS workstation.
Software Versions	(0018,1020)	3	Value set to "Reconstruction Package VERSION RECON_xx" where xx is the release number of the software the generated the breast tomosynthesis image.

5-6-5-2 Enhanced General Equipment Module

This section specifies the Attributes which identify and describe the piece of equipment which produced a Series of Composite Instances.

Table 11 ENHANCED GENERAL EQUIPMENT MODULE ATTRIBUTES

Attribute Name	Tag	Type	Attribute Description
Manufacturer	(0008,0070)	1	Described in General Equipment Module.
Manufacturer's Model Name	(0008,1090)	1	Described in General Equipment Module.
Device Serial Number	(0018,1000)	1	Described in General Equipment Module.
Software Versions	(0018,1020)	1	Described in General Equipment Module.

5-6-6 Common Image Entity Modules

These Image IE Modules are common to all Composite Image IODs which reference the Image IE.

5-6-6-1 Image Pixel Module

This section specifies the Attributes that describe the pixel data of the image.

Table 12 IMAGE PIXEL MODULE ATTRIBUTES

Attribute Name	Tag	Type	Attribute Description
Samples per Pixel	(0028,0002)	1	Always set to 1
Photometric Interpretation	(0028,0004)	1	Set to MONOCHROME2.
Rows	(0028,0010)	1	Set to the number of rows.
Columns	(0028,0011)	1	Set to the number of columns.
Bits Allocated	(0028,0100)	1	Set to 16
Bits Stored	(0028,0101)	1	Set to 12
High Bit	(0028,0102)	1	Set to 11
Pixel Representation	(0028,0103)	1	Always set to 0000H (unsigned integer)
Pixel Data	(7FE0,0010)	1	Always sent

5-6-6-2 Acquisition Context Module

The table in this Section contains IOD Attributes that describe the acquisition context while acquiring the MG image.

Table 13 ACQUISITION CONTEXT MODULE ATTRIBUTES

Attribute Name	Tag	Type	Attribute Description
Acquisition Context Sequence	(0040,0555)	2	Zero length value is sent

5-6-6-3 Multi-frame Functional Groups Module

The table in this Section contains IOD Attributes that describe Multi-frame Functional Groups Module.

Table 14 MULTI-FRAME FUNCTIONAL GROUPS MODULE ATTRIBUTES

Attribute Name	Tag	Type	Attribute Description
Shared Functional Groups Sequence	(5200,9229)	2	Sent with one item.
>Pixel Measures Sequence	(0028,9110)	1	Sent with one item.
>>Pixel Spacing	(0028,0030)	1C	Sent with value set to "0.1\0.1"
>>Slice Thickness	(0018,0050)	1C	Sent. Unit mm. For slabs, value set to slab thickness. For planes, value set to the distance between two planes.
>Plane Orientation Sequence	(0020,9116)	1	Sent with one item.
>>Image Orientation (Patient)	(0020,0037)	1C	Sent with 6 values. Row value for the x, y, and z axes respectively, followed by the Column value for the x, y, and z axes respectively.
>Derivation Image Sequence	(0008,9124)	2	Sent with one or two items for slabs. Sent with one item for planes if the image pixels have been subjected to a lossy compression. Sent with zero items otherwise.
>>Derivation Code Sequence	(0008,9215)	1	Sent with one or two items
>>>Code Value	(0008,0100)	1	Sent with value set to "113078" or "113040"
>>>Coding Scheme Designator	(0008,0102)	1	Sent with value set to "DCM"
>>>Code Meaning	(0008,0104)	1C	Sent with value set to "Maximum intensity projection" or "Lossy Compression"
>>Source Image Sequence	(0008,2112)	2	Sent with one or two items.
>>>Referenced SOP Class UID	(0008,1150)	1C	Sent with value set to Breast Tomosynthesis SOP Class UID: "1.2.840.10008.5.1.4.1.1.13.1.3"
>>>Referenced SOP Instance UID	(0008,1155)	1C	For Slabs, an item is sent with value set to SOP Instance UID (0008,0018) of corresponding Planes image. When lossy compression is applied, an item is sent with value set to SOP Instance UID (0008,0018) of corresponding uncompressed image.
>>>Purpose of Reference Code Sequence	(0040,A170)	1	Sent with one or two items.
>>>>Code Value	(0008,0100)	1	Sent with value set to "121322" or "121320"
>>>>Coding Scheme Designator	(0008,0102)	1	Sent with value set to "DCM"
>>>>Code Meaning	(0008,0104)	1C	Sent with value set to "Source image for image processing operation" or "Uncompressed predecessor"

Attribute Name	Tag	Type	Attribute Description
>Frame Anatomy Sequence	(0020,9071)	1	Sent with one item
>>Frame Laterality	(0020,9072)	1	Supported Values: R = right L = left B = both
>>>Anatomic Region Sequence	(0008,2218)	1	Sent with one item.
>>>>Code Value	(0008,0100)	1	Used Code: T-04000 for Breast
>>>>Coding Scheme Designator	(0008,0102)	1C	Always set to SRT
>>>>Code Meaning	(0008,0104)	1	Set to Breast
>Pixel Value Transformation Sequence	(0028,9145)	1	Sent with one item.
>>Rescale Intercept	(0028,1052)	1	Sent with value set to "0"
>>Rescale Slope	(0028,1053)	1	Sent with value set to "1"
>>Rescale Type	(0028,1054)	1	Sent with value set to "US"
>Frame VOI LUT Sequence	(0028,9132)	1	Sent with one item.
>>Window Center	(0028,1050)	1	Sent with one value.
>>Window Width	(0028,1051)	1	Sent with one value.
>>Window Center and Width Explanation	(0028,1055)	3	Sent with value set to "NORMAL"
>>VOI LUT Function	(0028,1056)	3	Sent with value set to "SIGMOID"
Per-frame Functional Groups Sequence	(5200,9230)	1	Sent with as many items as there are frames, starting with the frame at the detector level side.
>Frame Content Sequence	(0020,9111)	1	Sent with one item
>>Frame Reference DateTime	(0018,9151)	1C	Sent with value set to date and time when half the exposures were made to acquire the image.
>>>Frame Acquisition DateTime	(0018,9074)	1C	Sent with value set to the date and time the first exposure was made to acquire the image.
>>>>Frame Acquisition Duration	(0018,9220)	1C	Sent with value set to the time elapsed between first and last exposures made to acquire the image.
>Plane Position Sequence	(0020,9113)	1	Sent with one item.
>>Image Position (Patient)	(0020,0032)	1C	Sent with value set to "x\y\z" where x, y and z are the coordinates of the upper left hand corner of the slab/plane in mm.
>X-Ray 3D Frame Type Sequence	(0018,9504)	1	Sent with one item.

Attribute Name	Tag	Type	Attribute Description
>>Frame Type	(0008,9007)	1	Sent. For slabs value is set to "DERIVED\PRIMARY\VOLUME\NONE". For planes value is set to: - "ORIGINAL\PRIMARY\VOLUME\NONE" when lossy compression is not applied - "DERIVED\PRIMARY\VOLUME\NONE" otherwise.
>>Pixel Presentation	(0008,9205)	1	Sent with value set to "MONOCHROME"
>>Volumetric Properties	(0008,9206)	1	Sent. For slabs value is set to "SAMPLED" For planes value is set to "VOLUME"
>>Volume Based Calculation Technique	(0008,9207)	1	Sent. For slabs value is set to "MAX_IP". For planes value is set to "NONE".
>>Reconstruction Index	(0020,9536)	1C	Sent. Value is set to 1.
Instance Number	(0020,0013)	1	Sent. Value is generated by the system.
Content Date	(0008,0023)	1	Sent with value set to the date the image is created.
Content Time	(0008,0033)	1	Sent with value set to the time the image is created.
Number of Frames	(0028,0008)	1	Sent with value set to the total number of frames in the image.

5-6-6-4 X-Ray 3D Image Module

The table in this Section contains IOD Attributes that describe an X-Ray 3D image by specializing Attributes of the General Image and Image Pixel Modules, and adding additional attributes.

Table 15 X-RAY 3D IMAGE MODULE ATTRIBUTES

Attribute Name	Tag	Type	Attribute Description
Image Type	(0008,0008)	1	Sent. For slabs value is set to "DERIVED\PRIMARY\VOLUME\NONE" For planes value is set to: - "ORIGINAL\PRIMARY\VOLUME\NONE" when lossy compression is not applied - "DERIVED\PRIMARY\VOLUME\NONE" otherwise.
Pixel Presentation	(0008,9205)	1	Sent with value set to "MONOCHROME"
Volumetric Properties	(0008,9206)	1	Sent. For slabs value is set to "SAMPLED" For planes value is set to "VOLUME"
Volume Based Calculation Technique	(0008,9207)	1	Sent. For slabs value is set to "MAX_IP". For planes value is set to "NONE".

Attribute Name	Tag	Type	Attribute Description
Bits Allocated	(0028,0100)	1	Described in Image Pixel module
Bits Stored	(0028,0101)	1	Described in Image Pixel module
High Bit	(0028,0102)	1	Described in Image Pixel module
Samples Per Pixel	(0028,0002)	1	Described in Image Pixel module
Photometric Interpretation	(0028,0004)	1	Described in Image Pixel module
Content Qualification	(0018,9004)	1	Sent with value set to "PRODUCT"
Burned In Annotation	(0028,0301)	1	Sent with value set to "NO".
Lossy Image Compression	(0028,2110)	1	Sent with values: - "00" when lossy compression NOT applied. - "01" when lossy compression applied.
Lossy Image Compression Ratio	(0028,2112)	1C	Sent only when lossy compression applied.
Lossy Image Compression Method	(0028,2114)	1C	Sent only when lossy compression applied with value set to "ISO_10918_1 (i.e. JPEG Lossy Compression).
Presentation LUT Shape	(2050,0020)	1	Sent with value set to IDENTITY.

5-6-6-5 Breast Tomosynthesis Contributing Sources Module

The table in this Section contains IOD Attributes that describes the overall characteristics of one or more source images that were used to create a Breast Tomosynthesis Image SOP Class instance.

Table 16 BREAST TOMOSYNTHESIS CONTRIBUTING SOURCES MODULE ATTRIBUTES

Attribute Name	Tag	Type	Attribute Description
Contributing Sources Sequence	(0018,9506)	1	Sent with one item.
>Contributing SOP Instances Reference Sequence	(0020,9529)	1C	Sent with one item
>>Study Instance UID	(0020,000D)	1	Sent with value set to attribute Study Instance UID (0020,000D) in source images.
>>>Referenced Series Sequence	(0008,1115)	1	Sent with one item.
>>>>Series Instance UID	(0020,000E)	1	Sent with value set to attribute Series Instance UID (0020,000E) in source image.
>>>>Series Number	(0020,0011)	2	Sent with value set to attribute Series Number (0020,0011) in source image.
>>>>Referenced Instance Sequence	(0008,114A)	1	Sent with as many items as source images.
>>>>>Referenced SOP Class UID	(0008,1150)	1	Sent with value set to attribute SOP Class UID (0008,0016) of source image.
>>>>>Referenced SOP Instance UID	(0008,1155)	1	Sent with value set to attribute SOP Instance UID(0008,0018) of source image.
>>>>>Instance Number	(0020,0013)	2	Sent with value set to attribute Instance Number (0020,0013) of source image.

Attribute Name	Tag	Type	Attribute Description
>Manufacturer	(0008,0070)	2	Sent with value set to attribute Manufacturer (0008,0070) of source image.
>Manufacturer's Model Name	(0008,1090)	2	Sent with value set to attribute Manufacturer's Model Name (0008,1090) in source image.
>Device Serial Number	(0018,1000)	1C	Sent with value set to attribute Device Serial Number (0018,1000) in source image. This attribute is always present in source image.
>Software Versions	(0018,1020)	1C	Sent with value set to attribute Software versions (0018,1020) in source image. This attribute is always present in source image.
>Acquisition DateTime	(0008,002A)	1C	Sent with value set to combination of attributes Acquisition Date (0008,0022) and Acquisition Time (0008,0032) in source image. These attributes are always present in source image.
>Station Name	(0008,1010)	1C	Sent with value set to attribute Station Name (0008,1010) in source image. This attribute is always present in source image.
>Operators' Name	(0008,1070)	1C	Sent with value set to attribute Operator's name (0008,1070) in source image. This attribute is always present in source image.
>Protocol Name	(0018,1030)	1C	Sent with value set to attribute Protocol Name (0018,1030) in source image. This attribute is always present in source image.
>Acquisition Protocol Name	(0018,9423)	1C	Sent with value set to attribute Protocol Name (0018,1030) in source image. This attribute is always present in source image.
>Rows	(0028,0010)	1	Sent with value inferior or equal to attribute Rows (0028,0010) in source image.
>Columns	(0028,0011)	1	Sent with value inferior or equal to attribute Columns (0028,0011) in source image.
>Bits Stored	(0028,0101)	1	Sent with value set to attribute Bits Stored (0028,0101) in source image.
>Lossy Image Compression	(0028,2110)	1C	Sent with value set to attribute Lossy Image Compression (0028,2110) in source image. This attribute is always present in source image.
>Detector Type	(0018,7004)	1	Sent with value set to attribute Detector Type (0018,7004) in source image.
>Detector ID	(0018,700A)	1	Sent with value set to attribute Detector ID (0018,700A) in source image.
>Date of Last Detector Calibration	(0018,700C)	1	Sent with value set to attribute Date of Last Detector Calibration (0018,700C) in source image.

Attribute Name	Tag	Type	Attribute Description
>Time of Last Detector Calibration	(0018,700E)	1	Sent with value set to attribute Time of Last Detector Calibration (0018,700E) in source image.
>Detector Element Spacing	(0018,7022)	1	Sent with value set to attribute Detector Element Spacing (0018,7022) in source image.

5-6-6-6 Breast Tomosynthesis Acquisition Module

The table in this Section contains IOD Attributes that describe the Breast Tomosynthesis acquisition module.

Table 17 BREAST TOMOSYNTHESIS ACQUISITION MODULE ATTRIBUTES

Attribute Name	Tag	Type	Attribute Description
X-Ray 3D Acquisition Sequence	(0018,9507)	1	Sent with one item.
>Field of View Shape	(0018,1147)	1	Sent with value set to attribute Field of View Shape (0018,1147) in source image.
>X-Ray Receptor Type*	(0018,9420)	3	Sent with value set to "DIGITAL_DETECTOR"
>Source Image Sequence	(0008,2112)	1C	Sent with as many items as source images.
>>Referenced SOP Class UID	(0008,1150)	1	Sent with value set to attribute SOP Class UID (0008,0016) in source image.
>>Referenced SOP Instance UID	(0008,1155)	1	Sent with value set to attribute SOP Instance UID (0008,0018) in source image.
>Field of View Dimension(s) in Float	(0018,9461)	1C	Sent with value set to attribute Field of View Dimensions (0018,1149) in source image.
>Field of View Origin	(0018,7030)	1C	Sent with value set to attribute Field of View Origin (0018,7030) in source image.
>Field of View Rotation	(0018,7032)	1C	Sent with value set to attribute (0018,7032) in source image.
>Field of View Horizontal Flip	(0018,7034)	1C	Sent with value set to attribute Field of View Rotation (0018,7034) in source image
>Grid	(0018,1166)	1C	Sent with value set to attribute Grid (0018,1166) in source image.
>KVP	(0018,0060)	1C	Sent with value set to the average of the source images attribute KVP (0018,0060).
>X-Ray Tube Current in mA	(0018,9330)	1C	Sent with value set to the average of source images attribute X-Ray Tube Current (0018,1151).
>Exposure Time in ms	(0018,9328)	1C	Sent with value set the converted total of the source images attribute Exposure Time (0018,1150).

Attribute Name	Tag	Type	Attribute Description
>Exposure in mAs	(0018,9332)	1C	Sent with value set the converted total of the source images attribute Exposure (0018,1152).
>Start Acquisition DateTime	(0018,9516)	1C	Sent with value set to combination of source image attributes Acquisition Date (0008,0022) and Acquisition Time (0008,0032).
>Primary Positioner Scan Arc	(0018,9508)	1C	Sent with value set to the difference between attribute Positioner Primary Angle (0018,1510) in the last and first acquired source images.
>Primary Positioner Scan Start Angle	(0018,9510)	1C	Sent with value set to the converted value from first source image attribute Positioner Primary Angle (0018,1510).
>Primary Positioner Increment	(0018,9514)	1C	Sent with value set to converted absolute value from the difference between the values from the last and first source images Positioner Primary Angle (0018,1510), divided by the number of source images.
>Distance Source to Detector	(0018,1110)	1	Sent with value computed using source image attributes: Distance Source to Detector (0018,1110), Distance Source to Patient (0018,1111) and Detector Secondary Angle (0018,1531).
>Distance Source to Patient	(0018,1111)	1	Sent with value computed using source image attributes: Distance Source to Detector (0018,1110), Distance Source to Patient (0018,1111) and Detector Secondary Angle (0018,1531).
>Estimated Radiographic Magnification Factor	(0018,1114)	1	Sent with value set to attribute Estimated Radiographic Magnification Factor (0018,1114) in source image.
>Anode Target Material	(0018,1191)	1	Sent with value set to attribute Anode Target Material (0018,1191) in source image.
>Body Part Thickness	(0018,11A0)	1	Sent with value set to attribute Body Part Thickness (0018,11A0) in source image.
>Compression Force	(0018,11A2)	1	Sent with value set to attribute Compression Force (0018,11A2) in source image.
>Paddle Description	(0018,11A4)	1	Sent with value set to Paddle Description (0018,11A4) in source image.
>Exposure Control Mode	(0018,7060)	1	Sent with value set to attribute Exposure Control Mode (0018,7060) in source image.
>Exposure Control Mode Description	(0018,7062)	1	Sent with value set to attribute exposure Control Mode Description (0018,7062) in source image.

Attribute Name	Tag	Type	Attribute Description
>Half Value Layer	(0040,0314)	1	Sent with value set to attribute Half Value Layer (0040,0314) in source image.
>Focal Spot	(0018,1190)	1	Sent with value set to attribute Focal Spot (0018,1190) in source image.
>Detector Temperature	(0018,7001)	1	Sent with value set to attribute Detector Temperature (0018,7001) in source image.
>Filter Type	(0018,1160)	1	Sent with value set to attribute Filter Type (0018,1160) in source image.
>Filter Material	(0018,7050)	1	Sent with value set to attribute Filter Material (0018,7050) in source image.
>Organ Dose*	(0040,0316)	3	Sent with value set to the private attribute Organ Dose (0045,yyA4) with the private creator "GEMS_SENO_02" in source image.
>Per Projection Acquisition Sequence	(0018,9538)	1	Sent with as many items as source images.
>>KVP	(0018,0060)	1C	Sent with value set to attribute KVP (0018,0060) in source image.
>>X-Ray Tube Current in mA	(0018,9330)	1C	Sent with value set to conversion from attribute X-Ray Tube Current (0018,1151) in source image.
>>Collimator Shape	(0018,1700)	1C	Sent with value set to attribute Collimator Shape (0018,1700) in source image.
>>Collimator Left Vertical Edge	(0018,1702)	1C	Sent with value set to attribute Collimator Left Vertical Edge (0018,1702) in source image.
>>Collimator Right Vertical Edge	(0018,1704)	1C	Sent with value set to attribute Collimator Right Vertical Edge (0018,1704) in source image.
>>Collimator Upper Horizontal Edge	(0018,1706)	1C	Sent with value set to attribute Collimator Upper Horizontal Edge (0018,1706) in source image.
>>Collimator Lower Horizontal Edge	(0018,1708)	1C	Sent with value set to attribute Collimator Lower Horizontal Edge (0018,1708).
>>Positioner Primary Angle	(0018,1510)	1	Sent with value set to attribute Positioner Primary Angle (0018,1510) in source image.
>>Exposure Time in ms	(0018,9328)	1	Sent with value set to the conversion from attribute Exposure Time (0018,1150) in source image.
>>Exposure in mAs	(0018,9332)	1	Sent with value set to the convention from attribute Exposure (0018,1152) in source image.
>>Relative X-ray Exposure	(0018,1405)	1	Sent with value set to attribute Relative X-ray Exposure (0018,1405) in source image.

Attribute Name	Tag	Type	Attribute Description
>>Organ Dose	(0040,0316)	3	Sent with value set to attribute Organ Dose (0040,0316) in source image.
>>Entrance Dose in mGy	(0040,8302)	3	Sent with value set to attribute Entrance Dose in mGy (0040,8302) in source image.

* >Organ dose and X-Ray Receptor Type are described in the Breast Tomosynthesis Image IOD instances as a standard extended element.

5-6-6-7 X-Ray 3D Reconstruction Module

The table in this Section contains IOD Attributes that describe the reconstructions used to create this SOP Instance.

Table 18 X-RAY 3D RECONSTRUCTION MODULE ATTRIBUTES

Attribute Name	Tag	Type	Attribute Description
X-Ray 3D Reconstruction Sequence	(0018,9530)	1	Sent with one or more items
>Application Name	(0018,9524)	1	Sent with value set to Reconstruction Package VERSION RECON_<reconstruction_box_software_version>
>Application Version	(0018,9525)	1	Sent with value set to the reconstruction box software version.
>Application Manufacturer	(0018,9526)	1	Sent with value set to "GE MEDICAL SYSTEMS"
>Algorithm Type	(0018,9527)	1	Sent with value set to "ITERATIVE"
>Acquisition Index	(0020,9518)	1	Sent with value set to "1"

5-6-6-8 Breast View Module

The table in this Section contains IOD Attributes that describe the view of a Breast Tomosynthesis Image.

Table 19 BREAST VIEW MODULE ATTRIBUTES

Attribute Name	Tag	Type	Attribute Description
View Code Sequence	(0054,0220)	1	Sent with one item.
>Code Value	(0008,0100)	1	Sent with value copied from source image.
>Coding Scheme Designator	(0008,0102)	1	Sent with value copied from source image.
>Code Meaning	(0008,0104)	1	Sent with value copied from source image.
>View Modifier Code Sequence	(0054,0222)	2	Sent with zero or more items.
>>Code value	(0008,0100)	1C	Sent with value copied from source image.
>>Coding Scheme Designator	(0008,0102)	1C	Sent with value copied from source image.
>>Code Meaning	(0008,0104)	1C	Sent with value copied from source image.
Breast Implant Present	(0028,1300)	1C	Sent with value copied from source image.

5-6-6-9 SOP Common Module

The table in this Section contains IOD attributes for SOP Common Module.

Table 20 SOP COMMON MODULE ATTRIBUTES

Attribute Name	Tag	Type	Attribute Description
Specific Character Set	(0008,0005)	1C	Set to ISO_IR 100 = Latin Alphabet No. 1
SOP Class UID	(0008,0016)	1	Set to the Breast Tomosynthesis SOP Class UID: "1.2.840.10008.5.1.4.1.1.13.1.3"
SOP Instance UID	(0008,0018)	1	UID is generated by the system. When lossy compression is applied the UID is different from the one of the corresponding uncompressed instance.

5-6-7 Application Module (Private Module)

Application Module is a private module.

The table in this Section contains Attributes that describe various information required by the Senographe Essential Acquisition Workstation Medical Application.

Table 21 APPLICATION MODULE ATTRIBUTES

Attribute Name	Tag	Type	Attribute Description
Private Creator	(0045,0010)	3	Sent with value set to "GEMS_SENO_02"
Breast ROI X	(0045,1060)	3	Sent with value set to "top_left\top_right\bottom_right\bottom_left", where top_left, top_right, bottom_left, bottom_right are the x coordinates of the Breast ROI [pixels]
Breast ROI Y	(0045,1061)	3	Sent with value set to "top_left\top_right\bottom_right\bottom_left", where top_left, top_right, bottom_left, bottom_right are the y coordinates of the Breast ROI [pixels]
Radiological Thickness	(0045,1049)	3	Sent with value copied from source image.
SOP Instance UID for the lossy compression	(0045,10A6)	3	Sent with value set to the potential related SOP Instance that has lossy compression applied.
Reconstruction parameters	(0045,10A7)	3	Sent with values of configurable parameters used in the processing chain

5-7 Private Data Dictionary

The table in this section describes the Private Attributes contained in Breast Tomosynthesis images.

Table 22 Private Creator Identification (GEMS_SENO_02)

Attribute Name	Tag	VR	VM
Radiological Thickness	(0045,yy49)	DS	1
Breast ROI X	(0045,yy60)	IS	10
Breast ROI Y	(0045,yy61)	IS	10
SOP Instance UID for the lossy compression	(0045,yyA6)	UI	1
Reconstruction parameters	(0045,yyA7)	LT	1

5-8 Limitations summary

There are no known limitations for Breast Tomosynthesis Image IOD Implementation.

6 SC Information Object Implementation

6-1 Introduction

This section specifies the use of the DICOM Secondary Capture Image IODs to represent the information included in SC Images supported by this implementation. Corresponding attributes are conveyed using the module construct. The contents of this section are:

6-2 SC entity-relationship Model on page 107

6-3 Senographe Essential Acquisition workstation Mapping of DICOM entities on page 108

6-4 IOD Module table on page 109

6-5 SC-Information module definitions on page 109

6-2 SC entity-relationship Model

The Entity-Relationship diagram for the SC Image interoperability schema is shown in Illustration 1, In this figure, the following diagrammatic convention is established to represent the information organization:

- each entity is represented by a rectangular box
- each relationship is represented by a diamond shaped box.
- the fact that a relationship exists between two entities is depicted by lines connecting the corresponding entity boxes to the relationship boxes.

The relationships are fully defined with the maximum number of possible entities in the relationship shown. In other words, the relationship between Series and Image can have up to n Images per Series, but the Patient to Study relationship has 1 Patient for each Study (a Patient can have more than one Study on the system, however each Study will contain all of the information pertaining to that Patient).

Illustration 1 SC entity-relationship diagram

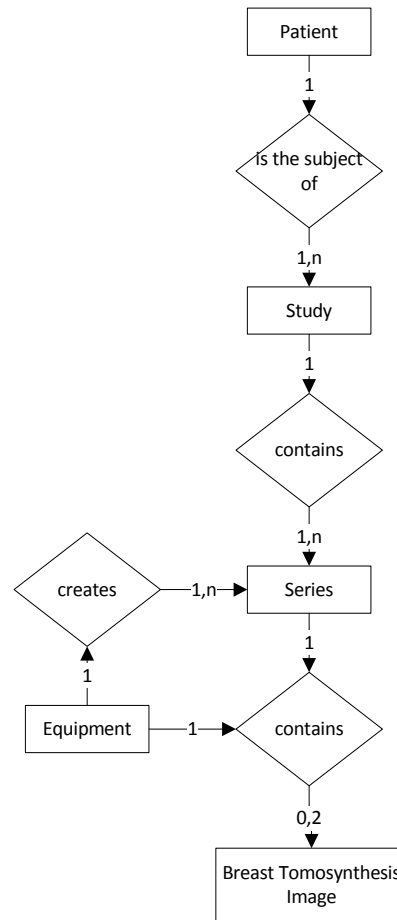

6-3 Senographe Essential Acquisition workstation Mapping of DICOM entities

The Senographe Essential Acquisition Workstation maps DICOM Information Entities to local Information Entities in the product’s database and user interface.

Table 1 Mapping of DICOM Entities to Senographe Essential Acquisition Workstation Entities

DICOM IE	Senographe Essential Acquisition Workstation Entity
Patient	Patient
Study	Study
Series	Series
Image	Image

6-4 IOD Module table

Table 2 on page 109 identifies the defined modules within the entities, which comprise the DICOM SC IOD. Modules are identified by Module Name.

Please refer to DICOM Part 3 (Information Object Definitions) for a description of each of the entities, modules, and attributes contained within the Information Object.

Table 2 SC Images IOD Modules

Entity Name	Module Name	Usage	Reference
Patient	Patient	Used	6-5-1-1
Study	General Study	Used	6-5-2-1
Series	General Studies	Used	6-5-3-1
Equipment	SC Equipment	Used	6-5-4-1
Image	General Image	Used	6-5-5-1
	Image Pixel	Used	6-5-5-2
	SC Image	Used	6-5-5-5
	Modality LUT	Not Used	6-5-5-3
	VOI LUT	Used if present	6-5-5-4
	SOP Common	Used	6-5-5-6

6-5 SC-Information module definitions

Please refer to DICOM Standard Part 3 (Information Object Definitions) for a description of each of the entities and modules contained within the SC Information Object.

The following modules are included to convey Supported Values, Supported Values, and Optional Attributes supported. Type 1 & Type 2 Attributes are also included for completeness and to define what values they may take and where these values are obtained from. It should be noted that they are the same ones as defined in the DICOM Standard Part 3 (Information Object Definitions).

It should also be noted that attributes not listed are ignored by the system when received.

6-5-1 Common Patient Entity Modules

6-5-1-1 Patient Module

This section specifies the Attributes of the Patient that describe and identify the Patient who is the subject of a diagnostic Study. This Module contains Attributes of the patient that are needed for diagnostic interpretation of the Image and are common for all studies performed on the patient.

Table 3 PATIENT MODULE ATTRIBUTES

Attribute Name	Tag	Type	Attribute Description
Patient's Name	(0010,0010)	2	Displayed if not empty.
Patient ID	(0010,0020)	2	Displayed if not empty.
Patient's Birth Date	(0010,0030)	2	Displayed if not empty.
Patient's Sex	(0010,0040)	2	Displayed if not empty.

6-5-2 Common Study Entity Modules

The following Study IE Modules are common to all Composite Image IODs which reference the Study IE. This Module contains Attributes of the patient and study that are needed for diagnostic interpretation of the image.

6-5-2-1 General Study Module

This section specifies the Attributes, which describe and identify the Study performed upon the Patient.

Table 4 GENERAL STUDY MODULE ATTRIBUTES

Attribute Name	Tag	Type	Attribute Description
Study Instance UID	(0020,000D)	1	Used
Study ID	(0020,0010)	2	Displayed if not empty
Study Date	(0008,0020)	2	Displayed if not empty
Study Time	(0008,0030)	2	Not Used
Accession Number	(0008,0050)	2	Displayed if not empty
Referring Physician's Name	(0008,0090)	2	Displayed if not empty
Study Description	(0008,1030)	3	Displayed if present

6-5-3 Common Series Entity Modules

The following Series IE Modules are common to all Composite Image IODs which reference the Series IE.

6-5-3-1 General Series Module

This section specifies the Attributes, which identify and describe general information about the Series within a Study.

Table 5 GENERAL SERIES MODULE ATTRIBUTES

Attribute Name	Tag	Type	Attribute Description
Modality	(0008,0060)	1	Supported Values: MG, OT, DX, CR
Series Description	(0008,103E)	3	Displayed if present
Performing Physicians' Name	(0008,1050)	3	Displayed if present
Operators' Name	(0008,1070)	3	Displayed if present
Series Instance UID	(0020,000E)	1	Used
Series Number	(0020,0011)	2	Displayed if not empty
Laterality	(0020,0060)	2C	Not Used

6-5-4 Common Equipment Entity Modules

The following Equipment IE Module is common to all Composite Image IODs which reference the Equipment IE.

6-5-4-1 SC Equipment Module

This Module describes equipment used to convert images into a DICOM format.

Table 6 SC EQUIPMENT MODULE ATTRIBUTES

Attribute Name	Tag	Type	Attribute Description
Modality	(0008,0060)	3	Value from General Series Module
Conversion type	(0008,0064)	1	

6-5-5 Common Image Entity Modules

The following Image IE Modules are common to all Composite Image IODs which reference the Image IE.

6-5-5-1 General Image Module

This section specifies the Attributes which identify and describe an image within a particular series.

Table 7 GENERAL IMAGE MODULE ATTRIBUTES

Attribute Name	Tag	Type	Attribute Description
Instance Number	(0020,0013)	2	Displayed if not empty
Patient Orientation	(0020,0020)	2C	
Content Date	(0008,0023)	2C	Not used
Content Time	(0008,0033)	2C	Not used
Burnt In Annotation	(0028,0301)	3	Not used
Lossy Image Compression	(0028,2110)	3	Not used

6-5-5-2 Image Pixel Module

This section specifies the Attributes that describe the pixel data of the image.

Table 8 IMAGE PIXEL MODULE ATTRIBUTES

Attribute Name	Tag	Type	Attribute Description
Samples per Pixel	(0028,0002)	1	Accepted value: 1
Photometric Interpretation	(0028,0004)	1	Supported Values: MONOCHROME1 MONOCHROME2
Rows	(0028,0010)	1	Supports images with rows < 2295
Columns	(0028,0011)	1	Supports images with columns < 2001
Bits Allocated	(0028,0100)	1	Supported value: 16
Bits Stored	(0028,0101)	1	Supported values: 12 14
High Bit	(0028,0102)	1	Supported values:11/13

Attribute Name	Tag	Type	Attribute Description
Pixel Representation	(0028,0103)	1	Supported Values: 0000H 0001H
Pixel Data	(7FE0,0010)	1	

6-5-5-3 Modality LUT module

This section specifies the Attributes that describe the Modality LUT.

Table 9 MODALITY LUT MODULE ATTRIBUTES

Attribute Name	Tag	Type	Attribute Description
Rescale Intercept	(0028,1052)	1C	Value supported: 0
Rescale Slope	(0028,1053)	1C	Value supported: 1
Rescale Type	(0028,1054)	1C	Defined Term: US

6-5-5-4 VOI LUT module

This section specifies the Attributes that describe the VOI LUT.

Table 10 VOI LUT MODULE ATTRIBUTES

Attribute Name	Tag	Type	Attribute Description
Window Center	(0028,1050)	3	One value is supported
Window Width	(0028,1051)	1C	One value is supported

6-5-5-5 SC Image module

The table in this Section contains IOD Attributes that describe SC images.

Table 11 SC IMAGE MODULE ATTRIBUTES

Attribute Name	Tag	Type	Attribute Description
Date of Secondary Capture	(0018,1012)	3	Displayed if present
Time of Secondary Capture	(0018,1014)	3	Displayed if present
Pixel Spacing	(0028,0030)	1C	Not used. System does not allow measurement for SC images

6-5-5-6 SOP Common Module

This section defines the Attributes, which are required for proper functioning and identification of the associated SOP Instances. They do not specify any semantics about the Real-World Object represented by the IOD.

Table 12 SOP COMMON MODULE ATTRIBUTES

Attribute Name	Tag	Type	Attribute Description
Specific Character Set	(0008,0005)	1C	Supported Values: ISO_IR 100 = Latin Alphabet No. 1
SOP Class UID	(0008,0016)	1	
SOP Instance UID	(0008,0018)	1	

7 Study Root Query/Retrieve - Information Model Definition

7-1 Introduction

This section specifies the use of the DICOM Study Root Query/Retrieve Model used to query information and retrieve data at study level. Retrieval of Breast Tomosynthesis Images is not supported.

The contents of this section are:

[7-2 Study Root Information Model Entity-Relationship Model on page 113](#)

[7-3 Information Model Keys on page 114.](#)

7-2 Study Root Information Model Entity-Relationship Model

The Entity-Relationship diagram for the Study Root Information Model schema is shown in Illustration 1. In this figure, the following diagrammatic convention is established to represent the information organization:

- each entity is represented by a rectangular box
- each relationship is represented by a diamond shaped box.
- the fact that a relationship exists between two entities is depicted by lines connecting the corresponding entity boxes to the relationship boxes.

The relationships are fully defined with the maximum number of possible entities in the relationship shown. In other words, the relationship between Series and Image can have up to n Images per Series.

Illustration 1 Study Root Query/Retrieve Information Model E/R DIAGRAM

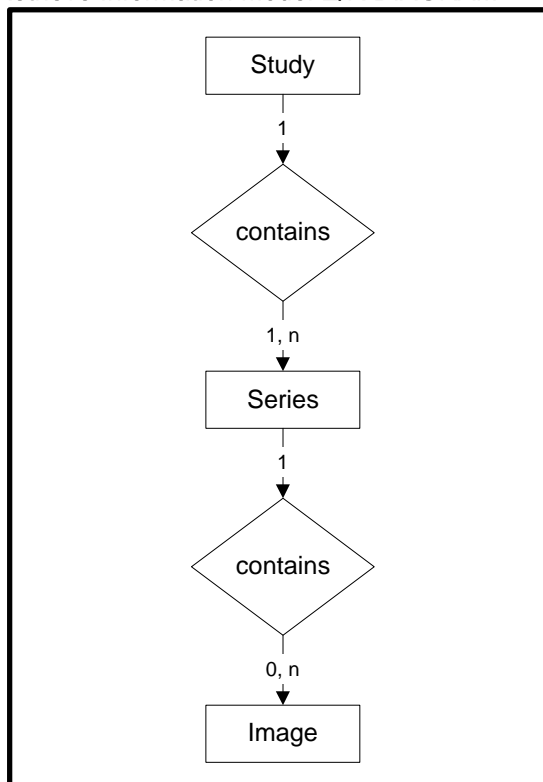

7-2-1 Entity Descriptions

Please refer to DICOM Standard PS 3.4 (Service Class Specifications) for a description of each of the levels contained within the Study Root Query/Retrieve Information Model.

7-2-2 Senographe Essential Acquisition Workstation Mapping of DICOM entities

Table 1 Mapping of DICOM Entities to Senographe Essential Acquisition Workstation Entities

DICOM	Senographe Essential Acquisition Workstation Entity
Study	Study
Series	Series
Image	Image

7-3 Information Model Keys

Please refer to DICOM Standard PS 3.4 (Service Class Specifications) for a description of each of the levels contained within the Study Root Query/Retrieve Information Model.

The following Level descriptions are included to specify what data elements are supported and what type of matching can be applied. It should be noted that they are the same ones as defined in the DICOM Standard PS 3.4 (Service Class Specifications).

7-3-1 Supported Matching

Following are the types of matching that can be requested by the implementation:

- Single Value matching
- Universal matching
- Range of date, Range of Time
- Wild char matching

7-3-2 Study Level

This section defines the keys at the Study Level of the Study Root Query/Retrieve Information Model that are supported by this implementation.

Table 2 STUDY Level Attributes for the Study Root Query/Retrieve Information Model

Attribute Name	Tag	Type	Attribute Description
Study Date	(0008,0020)	R	User Filtering is possible
Study Time	(0008,0030)	R	User Filtering is possible
Accession Number	(0008,0050)	R	
Study Description	(0008,0930)	O	
Patient's Name	(0010,0010)	R	User Filtering is possible, name starting with / ending with / containing value
Patient ID	(0010,0020)	R	User Filtering is possible, name starting with / ending with / containing value
Study ID	(0020,0010)	R	
Study Instance UID	(0020,000D)	U	

Note:

Only the ISO_IR 100 (ISO 8859-1:1987 Latin alphabet N 1. supplementary set) is supported as extended character sets. ISO IR 100 is not sent in the request but it is always assumed.

Table 3 Q/R STUDY Level and location for retrieve attributes

Attribute Name	Tag	Type	Note
Query Retrieve Level	(0008,0052)	-	Value = STUDY

7-3-3 Series Level

This section defines the keys at the Series Level of the Study Root Query/Retrieve Information Model that are supported by this implementation.

Table 4 SERIES Level Attributes for the Study Root - Query/Retrieve Information Model

Attribute Name	Tag	Type	Attribute Description
Modality	(0008,0060)	R	
Series Description	(0008,103E)	U	
Series Number	(0020,0011)	R	
Series Instance UID	(0020,000E)	U	

Table 5 Q/R SERIES Level and location for retrieve attributes

Attribute Name	Tag	Type	Note
Query Retrieve Level	(0008,0052)	-	Value = SERIES

7-3-4 Image Level

This section defines the keys at the Image Level of the Study Root Query/Retrieve Information Model that are supported by this implementation.

Table 6 IMAGE Level Attributes for the Study Root - Query/Retrieve Information Model

Attribute Name	Tag	Type	Attribute Description
SOP Instance UID	(0008,0018)	U	
Image Number	(0020,0013)	R	

Table 7 Q/R IMAGE Level and location for retrieve attributes

Attribute Name	Tag	Type	Note
Query Retrieve Level	(0008,0052)	-	Value = IMAGE

7-4 Private data dictionary

No private data dictionary is defined.

This page is intentionally left blank.

8 Modality Worklist Information Model Definition

8-1 Introduction

This section specifies the use of the DICOM Modality Worklist Information Model used to organize data and against which a Modality Worklist Query will be performed. The contents of this section are:

8-2 Modality Worklist Information Model Description on page 117

8-3 Modality Worklist Information Model Entity-Relationship Model on page 117

8-4 Information Model Module Table on page 119

8-5 Information Model Keys on page 120

8-6 Private data dictionary on page 128

8-2 Modality Worklist Information Model Description

In order to serve as a Service Class Provider (SCP) of the Modality Worklist Service Class, a DICOM Application Entity (AE) possesses information about the attributes of a number of managed worklist items. These items are organized into Modality Worklist Information Modules. In this Service Class, the Information Model plays a role similar to an Information Object Definition of most other DICOM Service Classes.

8-3 Modality Worklist Information Model Entity-Relationship Model

The Entity-Relationship diagram for the Modality Worklist Information Model schema is shown in [Illustration 1](#). It represents the information that composes a Worklist Item. In this figure, the following diagrammatic convention is established to represent the information organization:

- each entity is represented by a rectangular box
- each relationship is represented by a diamond shaped box.
- the fact that a relationship exists between two entities is depicted by lines connecting the corresponding entity boxes to the relationship boxes.

Illustration 1 Modality Worklist Information Model E/R DIAGRAM

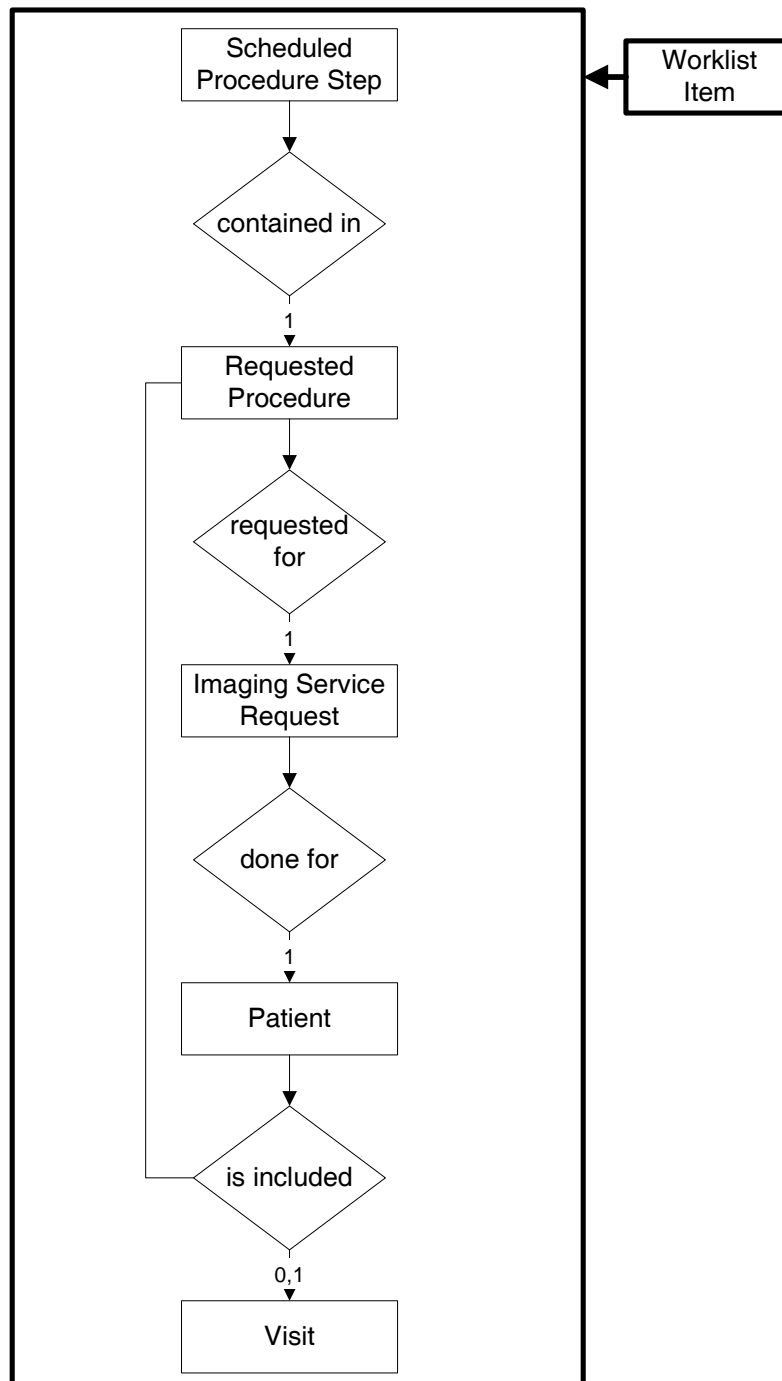

8-3-1 Entity Descriptions

Please refer to DICOM Standard PS 3.3. (Information Object Definitions) and PS 3.4 (Service Class Specifications) for a description of each of the Entities contained within the Modality Worklist Information Model.

8-3-1-1 Scheduled Procedure Step

A Scheduled Procedure Step is an arbitrarily defined scheduled unit of service that is specified by the Procedure Plan for a Requested Procedure. It specifies one or more Protocols (events) involving

equipment (i.e. imaging modality equipment), human resources, location and time (i.e. start time, stop time, duration).

8-3-1-2 Requested Procedure Entity Description

A Requested Procedure is an instance of a Procedure of a given Procedure Type. An instance of a Requested Procedure includes all of the items of information that are specified by an instance of a Procedure Plan that is selected for the Requested Procedure by the imaging service provider.

8-3-1-3 Imaging Service Request Entity Description

An Imaging Service Request is a set of one or more Requested Procedures selected from a list of Procedure Types. An Imaging Service Request is submitted by one authorized imaging service requester to one authorized imaging service provider in the context of one Service Episode.

8-3-1-4 Visit Entity Description

A Visit is the context in which the treatment or management of an arbitrary subset of a Patient's medical conditions occurs. A Visit is limited to the description of a Patient's activities at a single facility.

8-3-1-5 Patient Entity Description

A Patient is a person receiving, or registered to receive, health care services.

8-3-2 Senographe Essential Acquisition Workstation Mapping of DICOM entities

Table 1 Mapping of DICOM Entities to Senographe Essential Acquisition Workstation Entities

DICOM	Senographe Essential Acquisition Workstation Entity
Scheduled Procedure Step	Series
Requested Procedure	Study / Exam
Imaging Service Request	Study / Exam
Visit	Study / Exam
Patient	Patient

8-4 Information Model Module Table

Within an entity of the DICOM Modality Worklist Information Model, attributes are grouped into related set of attributes. A set of related attributes is termed a module. A module facilitates the understanding of the semantics concerning the attributes and how the attributes are related with each other. A module grouping does not infer any encoding of information into datasets.

[Table 2 on page 119](#) identifies the defined modules within the entities which comprise the DICOM Modality Worklist Information Model. Modules are identified by Module Name.

See DICOM PS 3.3 and PS 3.4 for a complete definition of the entities, modules, and attributes.

Table 2 Modality Worklist Information Model Modules

Entity Name	Module Name	Reference
Scheduled Procedure Step	SOP Common	8-5-2-1 SOP Common Module on page 122
	Scheduled Procedure Step	8-5-2-2 Scheduled Procedure Step Module on page 123
Requested Procedure	Requested Procedure	8-5-3-1 Requested Procedure Module on page 125

Imaging Service Request	Imaging Service Request	<i>8-5-4-1 Imaging Service Request Module on page 127</i>
Visit	Visit Identification	<i>8-5-5-1 Visit Identification on page 127</i>
	Visit Status	<i>8-5-5-2 Visit Status on page 127</i>
	Visit Relationship	<i>8-5-5-3 Visit Relationship on page 127</i>
	Visit Admission	<i>8-5-5-4 Visit Admission on page 128</i>
Patient	Patient Relationship	<i>8-5-6-1 Patient Relationship on page 128</i>
	Patient Identification	<i>8-5-6-2 Patient Identification on page 128</i>
	Patient Demographic	<i>8 Patient Identification Module Attributes on page 128</i>
	Patient Medical	<i>8-5-6-4 Patient Medical on page 128</i>

! **Notice:**

Any returned dataset not compliant with the DICOM return type (i.e. missing return type 1 and 2 elements) will be silently rejected by the WORKLIST SERVER AE and thus not displayed to the user.

8-5 Information Model Keys

Please refer to DICOM Standard PS 3.3. (Information Object Definitions) and PS 3.4 (Service Class Specifications) for a description of each of the Entities contained within the Modality Worklist Information Model.

The following Module descriptions are included to specify what data elements are supported and what type of matching can be applied. It should be noted that they are the same ones as defined in the DICOM Standard PS 3.4 (Service Class Specifications) and include:

Name

Tag group and element numbers

Expected Matching Key Type: R-required, O-optional

Expected Return Key Type:

1 - non-zero value required

1C - conditionally of type 1

2 - required to be present, possibly with zero-length value

2C - conditionally of type 2

3 - optional

Mapped into The Image - whether this data is mapped into subsequently acquired images

Notes - clarification of this implementation's use/treatment of this attribute

All data elements in the following Module descriptions are requested by default by the Worklist Server. Data elements for which values can be sent for matching purposes are described as such. Data elements for which values are not sent are sent with zero length and universal matching will apply. This is the default case if no other description to the contrary is provided.

8-5-1 Supported Matching

Following are the types of matching that can be request by the implementation:

8-5-1-1 *This System:*

Modality, (0008,0060) - set to MG

Scheduled Station AE Title, (0040,0001) - set to DICOM Server AE title

8-5-1-2 *This Modality:*

Modality, (0008,0060) - set to MG

Scheduled Station AE Title, (0040,0001) - zero-length (universal matching)

8-5-1-3 *All Systems:*

Modality, (0008,0060) - zero-length (universal matching)

Scheduled Station AE Title, (0040,0001) - zero-length (universal matching)

The scheduled dates of procedures of interest can be specified for query by selecting a specific date range. The date ranges available are *Today*, *Tomorrow*, or between two given dates. These selections and their effects on worklist query parameters are given below:

8-5-1-4 *Today:*

Scheduled Procedure Step Start Date, (0040,0002) - set to YYYYMMDD-YYYYMMDD, where YYYYMMDD is the current date.

8-5-1-5 *Tomorrow:*

Scheduled Procedure Step Start Date, (0040,0002) - set to YYYYMMDD-YYYYMMDD, where YYYYMMDD is tomorrow date.

8-5-1-6 *Between two dates:*

Scheduled Procedure Step Start Date, (0040,0002) - set to YYYYMMDD-YYYYMMDD', where YYYYMMDD is set to given From date and YYYYMMDD' is set to given To date.

8-5-1-7 *Patient Name:*

Patient Name, (0010,0010) - set to given Patient Name- Last name, first name, Middle names and titles can be sent using the DICOM 'PN' type syntax. Wild Char Matching is supported.

Examples:

Rev. John Robert Quincy Adams, B.A.M.Div.

Adams^John Robert Quincy Adams^^Rev.^B.A. M.Div."

[One family name; three given names; no middle name; one prefix; two suffixes.]

Susan Morrison-Jones, Ph.D., Chief Executive Officer

"Morrison-Jones^Susan^^Ph.D., Chief Executive Officer"

[Two family names; one given name; no middle name; no prefix; two suffixes.]

John Doe

"Doe^John"

[One family name; one given name; no middle name, prefix, or suffix. Delimiters have been omitted for the three trailing null components.]

8-5-1-8 *Patient ID:*

Patient ID, (0010,0020) - set to given Patient ID - Wild Char Matching is not supported.

8-5-1-9 *Accession number:*

Accession number (0008,0050) - set to given Accession Number.

8-5-1-10 *Requested Procedure ID:*

Requested Procedure ID (0040,1001) - set to given Requested Procedure ID.

8-5-2 Scheduled Procedure Step Entity

8-5-2-1 *SOP Common Module*

Table 3 SOP Common Module Attributes

Attribute Name	Tag	Expected Matching Key Type	Expected Returned Key Type	Mapped into the Image/MPPS	Displayed to User	Updatable by User	Note
Specific Character Set	(0008,0005)	O	1C	No/No	No	No	Note: This attribute is never sent nor used. It is assumed to be ISO_IR 100.

8-5-2-2 Scheduled Procedure Step Module

Table 4 Scheduled Procedure Step Module Attributes

Attribute Name	Tag	Expected Matching Key Type	Expected Returned Key Type	Mapped into the Image/MPPS	Displayed to User	Updatable by User	Note
Scheduled Procedure Step Sequence	(0040,0100)	R	1	No/No	N/A	N/A	
>Modality	(0008,0060)	R	1	No/No	No	No	Matching is supported as follows: either no Modality is supplied (universal matching), or the system's Modality is supplied (i.e. MG) for matching: this is user selectable.
>Scheduled Station AE Title	(0040,0001)	R	1	No/No	No	No	Matching is supported as follows: either no AE title is supplied (universal matching), or the Query AE title (corresponding to DICOM Server AE title) is supplied for matching; this is user selectable.
>Scheduled Procedure Step Start Date	(0040,0002)	R	1	No/No	Yes	No	Matching is supported as one of the following; this is user selectable: today only, tomorrow only, from date1 to date2, date1 and date2 being defined by user Returned values must be exactly 8 numeric characters, in YYYYMMDD or exactly 10 characters (8 numeric and 2 "." separators) YYYY.MM.DD format
>Scheduled Procedure Step Start Time	(0040,0003)	R	1	No/No	Yes	No	

Attribute Name	Tag	Expected Matching Key Type	Expected Returned Key Type	Mapped into the Image/MPPS	Displayed to User	Updatable by User	Note
>Scheduled Performing Physician's Name	(0040,0006)	R	2	Yes/Yes	Yes	Yes	
>Scheduled Procedure Step Description	(0040,0007)	O	1C	Yes/Yes	Yes	No	Note Attribute is mapped in image to Series Description (0008,103E) and >Scheduled Procedure Description (0040,0007). When updated by user, old value is not saved.
>Scheduled Protocol Code Sequence	(0040,0008)	O	1C	Yes/Yes	No	No	Note
>>Code Value	(0008,0100)	O	1C	Yes/Yes	No	No	
>>Coding Scheme Designator	(0008,0102)	O	1C	Yes/Yes	No	No	
>>Code Meaning	(0008,0104)	O	3	Yes/Yes	No	No	
>Scheduled Procedure Step ID	(0040,0009)	O	1	Yes/Yes	No	No	
>Scheduled Station Name	(0040,0010)	O	1	No/No	No	No	

Note:

Either the Schedule Procedure Step Description (0040, 0007) or the Scheduled Protocol code sequence (0040, 0008) or both shall be supported by the SCP.

8-5-3 Requested Procedure Entity*8-5-3-1 Requested Procedure Module***Table 5 Requested Procedure Module Attributes**

Attribute Name	Tag	Expected Matching Key Type	Expected Returned Key Type	Mapped into the Image/MPPS	Displayed to User	Updatable by User	Note
Referenced Study Sequence	(0008,1110)	O	2	Yes/Yes	No	No	
>Referenced SOP Class UID	(0008,1150)	O	1C	Yes/Yes	No	No	
>Referenced SOP Instance UID	(0008,1155)	O	1C	Yes/Yes	No	No	
Study Instance UID	(0020,000D)	O	1	Yes/Yes	No	No	
Requested Procedure Description	(0032,1060)	O	1C	Yes/Yes	Yes	Yes	Note Attribute is mapped in image to Study Description (0032,1060). When user modifies value, old value is not saved.
Requested Procedure Code Sequence	(0032,1064)	O	1C	Yes/No	No	No	Note
>Code Value	(0008,0100)	O	1C	Yes/No	No	No	
>Coding Scheme Designator	(0008,0102)	O	1C	Yes/No	No	No	
>Code Meaning	(0008,0104)	O	3	Yes/No	No	No	

Attribute Name	Tag	Expected Matching Key Type	Expected Returned Key Type	Mapped into the Image/MPPS	Displayed to User	Updatable by User	Note
Requested Procedure ID	(0040,1001)	O	1	Yes/Yes	Yes	no	Matching is supported as follow: either no Requested Procedure ID is supplied (universal matching), or the Requested Procedure ID entered by the user in the Query Definition screen is supplied for matching. Attribute is mapped in the image to Study ID (0020,0010).

Note:

The requested procedure description (0032,1060) or requested procedure code Sequence (0032,1064) or both shall be supported by the SCP.

8-5-4 Imaging Service Request Entity*8-5-4-1 Imaging Service Request Module***Table 6 Imaging Service Request Module Attributes**

Attribute Name	Tag	Expected Matching Key Type	Expected Returned Key Type	Mapped into the Image/MPPS	Displayed to User	Updatable by User	Note
Accession Number	(0008,0050)	O	2	Yes/Yes	Yes	Yes if not provided by HIS	Matching is supported as follow: either no accession number is supplied (universal matching), or the accession number entered by the user in the Query Definition screen is supplied for matching.
Referring Physician's Name	(0008,0090)	O	2	Yes/No	Yes	Yes	

8-5-5 Visit Entity*8-5-5-1 Visit Identification*

None of the data elements from Visit Identification Module are requested

8-5-5-2 Visit Status

None of the data elements from Visit Status Module are requested

*8-5-5-3 Visit Relationship***Table 7 Visit Relationship Module Attributes**

Attribute Name	Tag	Expected Matching Key Type	Expected Returned Key Type	Mapped into the Image/MPPS	Displayed to User	Updatable by User	Note
Referenced Patient Sequence	(0008,1120)	O	2	Yes/Yes	No	No	
>Referenced SOP Class UID	(0008,1150)	O	1C	Yes/Yes	No	No	
>Referenced SOP Instance UID	(0008,1155)	O	1C	Yes/Yes	No	No	

8-5-5-4 Visit Admission

None of the data elements from Visit Admission Module are requested.

8-5-6 Patient Entity**8-5-6-1 Patient Relationship**

None of the data elements from Patient Relationship Module are requested.

8-5-6-2 Patient Identification**Table 8 Patient Identification Module Attributes**

Attribute Name	Tag	Expected Matching Key Type	Expected Returned Key Type	Mapped into the Image/MPPS	Displayed to User	Updatable by User	Note
Patient's Name	(0010,0010)	R	1	Yes/Yes	Yes	Yes if not provided by HIS	Matching is supported as follow: either no patient name is supplied (universal matching), or the patient name entered by the user in the Query Definition screen is supplied for matching. Wild char matching is supported.
Patient ID	(0010,0020)	R	1	Yes/Yes	Yes	Yes if not provided by HIS	Matching is supported as follow: either no patient ID is supplied (universal matching), or the patient ID entered by the user in the Query Definition screen is supplied for matching. Wild char matching is supported.

8-5-6-3 Patient Demographic**Table 9 Patient Demographic Module Attributes**

Attribute Name	Tag	Expected Matching Key Type	Expected Returned Key Type	Mapped into the Image/MPPS	Displayed to User	Updatable by User	Note
Patients Birth Date	(0010,0030)	O	2	Yes/Yes	Yes	Yes	
Patient's Sex	(0010,0040)	O	2	Yes/Yes	Yes	Yes	

8-5-6-4 Patient Medical

None of the data elements from Patient Medical Module are requested

8-6 Private data dictionary

The Senographe Essential Acquisition Workstation implementation does not define any Private Attributes within the Modality Worklist Information Model.

9 Print Management Implementation

9-1 Introduction

This section of the DICOM Conformance Statement specifies the supported Print Management SOP and Meta SOP Classes, the optional attributes and service elements supported, the valid range of values for mandatory and optional attributes, and the status code behavior.

The next section contains:

[9-2-1 Basic Film Session SOP Class on page 129](#)

[9-2-2 Basic Film Box SOP Class on page 130](#)

[9-2-4 Presentation LUT SOP Class on page 134](#)

[9-2-5 Printer SOP Class on page 135](#)

[9-2-6 Print Job SOP Class on page 136](#)

[9-2-7 Basic Annotation Box SOP Class on page 136](#)

[9-2-8 Image Overlay Box SOP Class on page 136](#)

9-2 Print management SOP class definitions

9-2-1 Basic Film Session SOP Class

The DICOM Print SCU AE supports the N-CREATE DIMSE Service Element for the Basic Film Session SOP Class.

- The N-CREATE DIMSE Service element sent by the DICOM Print SCU AE requests the Remote DICOM Print SCP to create an instance of Basic Film Session.

9-2-1-1 IOD Description

9-2-1-1-1. IOD modules

Module	Reference	Module Description
SOP Common		Contains SOP Common information
Basic Film Session Presentation Module	9-2-1-2-1-1	Contains Film Session presentations information

9-2-1-2 DIMSE Service Group

DIMSE Service Element	Usage SCU
N-CREATE	M
N-SET	Not used
N-DELETE	Not used
N-ACTION	Not used

9-2-1-2-1. N-CREATE

9-2-1-2-1-1. Attributes

Attribute name	Tag	Use
Number of Copies	(2000,0010)	Used. Value from 1 to 10.
Print Priority	(2000,0020)	Used. Value is HIGH or MED or LOW depending of configuration of associated Remote DICOM printer.

Attribute name	Tag	Use
Medium Type	(2000,0030)	Used. Value is PAPER or CLEAR FILM or BLUE FILM depending of configuration of associated Remote DICOM printer
Film Destination	(2000,0040)	Used. Value is MAGAZINE or PROCESSOR depending of configuration of associated Remote DICOM printer
Film Session Label	(2000,0050)	Used, not sent if empty. Human readable label that identifies the film session. depending of configuration of associated Remote DICOM printer. Empty by default or set to free text.
Memory Allocation	(2000,0060)	Not used

9-2-1-2-1-2. Behavior

No specific behavior.

9-2-1-2-2. N-SET

This service is not used.

9-2-1-2-3. N-DELETE

This service is not used.

9-2-1-2-4. N-ACTION

This service is not used.

9-2-2 Basic Film Box SOP Class

The DICOM Print SCU AE supports the following DIMSE Service Element for the Basic Film Box SOP Class.

- The N-CREATE DIMSE Service element sent by the DICOM Print SCU AE requests the Remote DICOM Print SCP to create an instance of Basic Film Box
- The N-ACTION DIMSE Service element sent by the DICOM Print SCU AE requests the Remote DICOM Print SCP to print the Basic Film Box onto the hard copy printer.
- The N-DELETE DIMSE Service element sent by the DICOM Print SCU AE requests the Remote DICOM Print SCP to release the Basic Film Box instance.

9-2-2-1 IOD Description

9-2-2-1-1. IOD modules

Module	Reference	Module Description
SOP Common		Contains SOP Common information
Basic Film Box Presentation Module	9-2-2-2-1-1	Contains Film Box presentation information
Basic Film Box Relationship	9-2-2-2-1-1	References to related SOPs

9-2-2-2 DIMSE Service Group

DIMSE Service Element	Usage SCU
N-CREATE	M
N-ACTION	M
N-DELETE	Used

9-2-2-2-1. N-CREATE

9-2-2-2-1-1. Attributes

Attribute Name	Tag	Attribute Description
Image Display Format	(2010,0010)	Used. Always set to STANDARD\1,1
Film Orientation	(2010,0040)	Used. Values are: PORTRAIT LANDSCAPE
Film Size ID	(2010,0050)	Used. Values are: 8INX10IN 10INX12IN 10INX14IN 11INX14IN 14INX14IN 14INX17IN 24CMX24CM 24CMX30CM
Magnification Type	(2010,0060)	Used. One of the following defined term is sent: REPLICATE BILINEAR CUBIC NONE
Smoothing Type	(2010,0080)	Used. Only valid for Magnification type = CUBIC
Border density	(2010,0100)	Used. BLACK or WHITE depending of configuration of associated Remote DICOM printer.
Empty Image Density	(2010,0110)	Used. BLACK or WHITE depending of configuration of associated Remote DICOM printer.
Min Density	(2010,0120)	Used. -1 by default or set to positive integer
Max Density	(2010,0130)	Used. -1 by default or set to positive integer
Trim	(2010,0140)	Used, not sent if empty. Empty by Default or set to YES or NO according to value set by user when declaring the printer
Configuration information	(2010,0150)	Sent when no review room is declared or no presentation LUT SOP Class negotiated.
Illumination	(2010,015E)	Used if presentation LUT SOP Class successfully negotiated. Set to a value defined when review room is declared. Not sent if no review room is declared

Attribute Name	Tag	Attribute Description
Reflected Ambient light	(2010, 0160)	Used if presentation LUT SOP Class successfully negotiated.
Referenced Film Session Sequence	(2010,0500)	Used as received in previous message exchange
>Referenced SOP Class UID	(0008,1150)	Used as received in previous message exchange
>Referenced SOP Instance UID	(0008,1155)	Used as received in previous message exchange
Referenced Presentation LUT Sequence	(2010,0500)	Used if presentation LUT SOP Class successfully negotiated. Used as received in previous message exchange
>Referenced SOP Class UID	(0008,1150)	Used as received in previous message exchange
>Referenced SOP Instance UID	(0008,1155)	Used as received in previous message exchange
Referenced Image Box Sequence	(2010,0510)	Not used
>Referenced SOP Class UID	(0008,1150)	Not used
>Referenced SOP Instance UID	(0008,1155)	Not used
Referenced Image Box Sequence	(2010,0510)	Used. Not sent in N_Create_RQ but received in N_Create_RSP
>Referenced SOP Class UID	(0008,1150)	Used. Not sent in N_Create_RQ but received in N_Create_RSP
>Referenced SOP Instance UID	(0008,1155)	Used. Not sent in N_Create_RQ but received in N_Create_RSP

9-2-2-2-1-2. Behavior

There is no specific behavior.

9-2-2-2-2. N-DELETE

9-2-2-2-2-1. Behavior

The SCU uses the N-DELETE to request the SCP to delete the Basic Film Box SOP Instance hierarchy.

9-2-2-2-3. N-ACTION

N-ACTION is used to print the current film of the film session.

9-2-2-2-3-1. Attributes

Action Type Name	Action Type ID	Attribute	Tag	Usage SCU
Print	1	Referenced Print Job Sequence	(2100,0500)	Not used
		>Referenced SOP Class UID	(0008,1150)	Not used
		>Referenced SOP Instance UID	(0008,1155)	Not used

9-2-2-2-3-2. Behavior

SCU uses the N-ACTION to request the SCP to print one or more copies of a single film of the film session.

9-2-3 Image Box SOP Classes**9-2-3-1 Basic Grayscale Image Box SOP Class**

The DICOM Print SCU AE supports the following DIMSE Service Element for the Basic Grayscale Image Box SOP Class.

- The N-SET DIMSE Service element sent by the DICOM Print SCU AE requests the Remote DICOM Print SCP to set the attributes of the Basic Grayscale Image Box Instance.

9-2-3-1-1. IOD description

9-2-3-1-1-1. ID modules

Module	Reference	Module Description
SOP Common		Contains SOP Common information
Image Box Presentation Module	9-2-3-1-2-1	Contains Image Box presentation information

9-2-3-1-2. DIMSE Service Group

DIMSE Service Element	Usage SCU
N-SET	M

9-2-3-1-2-1. N-SET

9-2-3-1-2-1-1. Attributes

Attribute Name	Tag	Attribute Description
Image Box Position	(2020,0010)	Used. Set to 1
Polarity	(2020,0020)	Used. Possible values are: NORMAL = pixels shall be printed as specified by the Photometric Interpretation (0028,0004) REVERSE = pixels shall be printed with the opposite polarity as specified by the Photometric Interpretation (0028,0004)
Magnification Type	(2010,0060)	Used. Same value as defined in the Film Box.
Smoothing Type	(2010,0080)	Used, not sent if empty or magnification is not equal to CUBIC. Same value as defined in the Film Box
Preformatted Grayscale Image Sequence	(2020,0110)	Used. This sequence is always included if the Image Box is a Basic Grayscale Image Box
>Samples Per Pixel	(0028,0002)	Used. Set to 1
>Photometric Interpretation	(0028,0004)	Used. Value is MONOCHROME1 or MONOCHROME2 depending of configuration of associated Remote DICOM printer.
>Rows	(0028,0010)	Used. Original image height
>Columns	(0028,0011)	Used. Original image width
>Pixel Aspect Ratio	(0028,0034)	Used. value set to 1\1
>Bits Allocated	(0028,0100)	Used. Depends on the original image pixel depth (8 or 16).

Attribute Name	Tag	Attribute Description
>Bits Stored	(0028,0101)	Used. Original image pixel depth (8, 10 or 12 bits).
>High Bit	(0028,0102)	Used. Depends on the original image pixel depth (7, 9 or 11).
>Pixel Representation	(0028,0103)	Used. Set to 0 (Unsigned Integer)
>Pixel Data	(7FE0,0010)	Used

Note:

Bits Stored (0028,0101) may have the value 10 if selected by the user. Please note that this value is not DICOM compliant.

9-2-3-1-2-1-2. Behavior

There is no specific behavior.

The SCU does not instruct the SCP to erase the image in the image position by setting a zero length and no value in the Attribute Preformatted Grayscale Image Sequence (2020,0110) or Preformatted Grayscale Image Sequence (2020,0111)

9-2-4 Presentation LUT SOP Class

The DICOM Print SCU AE supports the N-CREATE DIMSE Service Element for the Presentation LUT SOP Class.

- The N-CREATE DIMSE Service element sent by the DICOM Print SCU AE requests the Remote DICOM Print SCP to create an instance of Presentation LUT.

9-2-4-1 *IOD Description*

9-2-4-1-1. IOD modules

Module	Reference	Module Description
SOP Common		Contains SOP Common information
Presentation LUT Module	9-2-4-2-1-1	Contains annotation presentation information

9-2-4-2 *DIMSE Service Group*

DIMSE Service Element	Usage SCU
N-CREATE	M
N-DELETE	Not Used

9-2-4-2-1. N-CREATE

9-2-4-2-1-1. Attributes

Attribute Name	Tag	Attribute Description
Presentation LUT Shape	(2050,0020)	Used. Value set to IDENTITY

9-2-4-2-1-2. Behavior

No specific behavior

9-2-4-2-2. N-DELETE

This service is not used.

9-2-5 Printer SOP Class

The DICOM Print SCU AE supports the following DIMSE Service Element for the Basic Printer SOP Class.

The N-EVENT_REPORT DIMSE Service element sent by the DICOM Print SCP to the local DICOM Print SCU AE. The DICOM Print SCU handles the Printer Status and Printer Status Info fields. All other received data are ignored.

The N-GET DIMSE Service element sent by the DICOM Print SCU AE requests the Remote DICOM Print SCP to give information on the Remote DICOM Printer.

9-2-5-1 IOD Description**9-2-5-1-1. IOD modules**

Module	Reference	Module Description
SOP Common		Contains SOP Common information
Printer Module		Contains status information to monitor the printer

9-2-5-2 DIMSE Service Group

DIMSE Service Element	Usage SCU
N-EVENT-REPORT	M
N-GET	U

9-2-5-2-1. N-EVENT-REPORT**9-2-5-2-1-1. Attributes**

Event Type Name	Event Type ID	Attribute	Tag	Usage SCU
Normal	1			The behavior consists on continuing association
Warning	2	Printer Name	(2110,0030)	
		Printer Status Info	(2110,0020)	The behavior consists on releasing the association except if Printer Status Info is: SUPPLY LOW SUPPLY EMPTY
Failure	3	Printer Name	(2110,0030)	
		Printer Status Info	(2110,0020)	The behavior consists on releasing association.

Note:

The N-EVENT-REPORT is delayed for a time defined in the file ~sdc/app-defaults/dicom_print/dprint.cfg. The default time-out is set to 30 seconds.

9-2-5-2-1-2. Behavior

If Event Type Name is FAILURE

Revision 1

DICOM CONFORMANCE STATEMENT 5415902-2-8EN

Signal print failure to the user
 Else If Event Type Name is WARNING and Printer Status Info is not equal to SUPPLY LOW or SUPPLY EMPTY
 Signal print warning to the user
 Else
 Signal print success to the user
 9-2-5-2-2. N-GET
 9-2-5-2-2-1. Attributes

Attribute Name	Tag	Attribute Description
Manufacturer	(0008,0070)	Used. Printer may return an empty value
Manufacturer Model Name	(0008,1090)	Used. Printer may return an empty value
Device Serial Number	(0018,1000)	Used. Printer may return an empty value
Software Versions	(0018,1020)	Used. Printer may return an empty value
Date Of Last Calibration	(0018,1200)	Used. Printer may return an empty value
Time Of Last Calibration	(0018,1201)	Used. Printer may return an empty value
Printer Status	(2110,0010)	Used. The behavior defined for the following term NORMAL: Association goes on. FAILURE: Association is aborted. WARNING: Association is released except if Printer Status Info is: SUPPLY LOW SUPPLY EMPTY
Printer Status Info	(2110,0020)	Used. The behavior is defined for SUPPLY LOW and SUPPLY EMPTY (See upwards)
Printer Name	(2110,0030)	Used. Printer may return an empty value

9-2-5-2-2-2. Behavior
 If Printer Status is FAILURE
 Signal print failure to the user
 Else If Printer Status is WARNING and Printer Status Info is not equal to SUPPLY LOW or SUPPLY EMPTY
 Signal print warning to the user
 Else
 Signal print success to the user

9-2-6 Print Job SOP Class

This SOP Class is not supported by this implementation.

9-2-7 Basic Annotation Box SOP Class

This SOP Class is not supported by this implementation.

9-2-8 Image Overlay Box SOP Class

This SOP Class is not supported by this implementation

10 Storage commitment Push Model SOP Class Definition

10-1 Introduction

This section of the DICOM Conformance Statement specifies the Storage Commitment Push Model SOP Class, the optional attributes and service elements supported, the valid range of values for mandatory and optional attributes, and the status code behavior.

10-2 Storage Commitment Push Model SOP class definition

10-2-1 DIMSE Service Group

DIMSE Service Element	Usage SCU/SCP
N-EVENT-REPORT	M/M
N-ACTION	M/M

10-2-2 Operations

10-2-2-1 Action Information

Table 1 STORAGE COMMITMENT REQUEST - ACTION INFORMATION

Attribute Name	Tag	SCU Use
Storage Media File-Set ID	(0088,0130)	Not used
Storage Media File-Set UID	(0088,0140)	Not used
Transaction UID	(0008,1195)	Used to link the request with the N-Event-Report
Referenced SOP Sequence	(0008,1199)	Used to identify images to commit
>Storage Media File-Set ID	(0088,0130)	Supported but ignored
>Storage Media File-Set UID	(0088,0140)	Supported but ignored
>Referenced SOP Class UID	(0008,1150)	Used
>Referenced SOP Instance UID	(0008,1155)	Used

10-2-2-2 Service Class User Behavior

N-ACTION is sent when the images are successfully sent to a remote host declared as Storage Commitment Provider on the Senographe Essential Acquisition Workstation.

Storage Commitment can be requested for Digital Mammography X-ray SOP Class Images For Presentation and For Processing, and for Breast Tomosynthesis Images.

Referenced Performed Procedure Step is not supported.

The transaction UID is applicable until we receive the N-EVENT-REPORT.

Storage Media File-Set ID & UID Attributes in the N-ACTION are not supported.

When receiving an unsuccessful N-ACTION Response Status Code from the SCP, we log the error in a log file and we display a pop-up to the user.

10-2-3 Notifications*10-2-3-1 Event Information***Table 2 STORAGE COMMITMENT RESULT - EVENT INFORMATION**

Attribute Name	Tag	SCU Use
Retrieve AE Title	(0008,0054)	Not used
Storage Media File-Set ID	(0088,0130)	Not used
Storage Media File-Set UID	(0088,0140)	Not used
Transaction UID	(0008,1195)	Used to identify the associated request
Failed SOP Sequence	(0008,1198)	Used to identify the instances whose commitment has failed. Used when event type ID is 2 which corresponds to Request Complete - Failures Exist
>Referenced SOP Class UID	(0008,1150)	Used
>Referenced SOP Instance UID	(0008,1155)	Used
>Failure Reason	(0008,1197)	Used. All values from table 3 are supported.
Referenced SOP Sequence	(0008,1199)	Used to identify instances whose commitment has succeeded
>Retrieve AE Title	(0008,0054)	Supported but ignored
>Storage Media File-Set ID	(0088,0130)	Supported but ignored
>Storage Media File-Set UID	(0088,0140)	Supported but ignored
>Referenced SOP Class UID	(0008,1150)	Used
>Referenced SOP Instance UID	(0008,1155)	Used

10-2-3-2 Service Class User Behavior

When receiving the N-EVENT-REPORT, system looks first for the SOP Instance UID successfully committed. It records them in a log file and flag them in the local database as Committed. Secondly, the system looks for the SOP Instance UID for which the commit failed. It also records them in a log file with the failure reason and display a pop-up to the user.

Table 3 Failure Reason Values and Semantics

Failure Reason	Meaning	SCU Behavior
0110H	Processing failure	Logged into log file Pop-up displayed to user to warn him that images from patient X could not be committed.
0112H	No such object instance	Logged into log file Pop-up displayed to user to warn him that images from patient X could not be committed.
0213H	Resource limitation	Logged into log file Pop-up displayed to user to warn him that images from patient X could not be committed.
0122H	Referenced SOP Class not supported	Logged into log file Pop-up displayed to user to warn him that images from patient X could not be committed.
0119H	Class / Instance conflict	Logged into log file Pop-up displayed to user to warn him that images from patient X could not be committed.
0131H	Duplicate transaction UID	Logged into log file Pop-up displayed to user to warn him that images from patient X could not be committed.

10-2-3-3 Status Codes returned

Status Code values returned to SCP Equipment in the N-Event-Report Response are defined in Section [2-3-3-1-6-1-2-1](#).

This page is intentionally left blank.

11 Modality Performed Procedure Step SOP Class Definition

11-1 Introduction

This section of the DICOM conformance statement specifies the Modality Performed Procedure Step SOP class, the optional attributes and service elements supported, the valid range of values for mandatory and optional attributes, and the status code behavior.

11-2 Modality Performed Procedure Step SOP class definition

11-2-1 IOD description

The MPPS feature of the Senographe Essential supports only the attributes listed in Table 1 on page 141. The type 2 elements as per table F.7.2.1 from the DICOM PS3.4 standard not listed here are sent with a zero length.

The following table gives specific usage of the attributes in the MPPS SOP instance created, with reference to each of the real-world scenarios mentioned in section 2-2-3 of this document.

Table 1 MPPS use of DICOM data

Attribute Name	Tag	N-Create		N-Set		Image Header
		Acquisition with MWL data	Acquisition without MWL data	Acquisition with MWL data	Acquisition without MWL data	
Specific character set	(0008,0005)	ISO_IR 100	ISO_IR 100	N/A	N/A	Yes
Modality	(0008,0060)	MG	MG	N/A	N/A	Yes
Procedure code sequence	(0008,1032)	MWL SCP data	sent with 0 length	not sent	not sent	Yes ***
>Code Value	(0008,0100)	MWL SCP data	N/A	N/A	N/A	Yes ***
>Coding Scheme designator	(0008,0102)	MWL SCP data	N/A	N/A	N/A	Yes ***
>Code meaning	(0008,0104)	MWL SCP data	N/A	N/A	N/A	Yes ***
Referenced Patient Sequence	(0008,1120)	MWL SCP data	sent with 0 length	N/A	N/A	Yes ***
>Referenced SOP Class UID	(0008,1150)	MWL SCP data	N/A	N/A	N/A	Yes***
>Referenced SOP Instance UID	(0008,1155)	MWL SCP data	N/A	N/A	N/A	Yes***

Attribute Name	Tag	N-Create		N-Set		Image Header
		Acquisition with MWL data	Acquisition without MWL data	Acquisition with MWL data	Acquisition without MWL data	
Anatomic structure, space or region sequence	(0008,2229)	sent with 0 length	sent with 0 length	Sent with 0 length when referencing only Breast Tomosynthesis Image instances. Otherwise, sent with following values:	Sent with 0 length when referencing only Breast Tomosynthesis Image instances. Otherwise, sent with following values:	No
>Code Value	(0008,0100)	N/A	N/A	T-04000	T-04000	No
>Coding Scheme designator	(0008,0102)	N/A	N/A	SNM3 or SRT	SNM3 or SRT	No
>Code meaning	(0008,0104)	N/A	N/A	Breast	Breast	No
Patient's Name	(0010,0010)	MWL SCP data	User entered	N/A	N/A	Yes
Patient ID	(0010,0020)	MWL SCP data	User entered	N/A	N/A	Yes
Patient's Birth Date	(0010,0030)	MWL SCP data	User entered	N/A	N/A	Yes
Patient's Sex	(0010,0040)	MWL SCP data	User entered	N/A	N/A	Yes
Study ID	(0020,0010)	MWL SCP data	User entered	N/A	N/A	Yes
Performed station AE Title	(0040,0241)	set to the station DICOM SERVER AE	set to the station DICOM SERVER AE	N/A	N/A	No
Performed station name	(0040,0242)	set to the station hostname	set to the station hostname	N/A	N/A	No
Performed location	(0040,0243)	sent with 0 length	sent with 0 length	N/A	N/A	No
Performed procedure step start date	(0040,0244)	Exam start date	Exam start date	N/A	N/A	Yes
Performed procedure step start time	(0040,0245)	Exam start time	Exam start time	N/A	N/A	Yes

Attribute Name	Tag	N-Create		N-Set		Image Header
		Acquisition with MWL data	Acquisition without MWL data	Acquisition with MWL data	Acquisition without MWL data	
Performed procedure step end date	(0040,0250)	sent with 0 length	sent with 0 length	Exam close date	Exam close date	No
Performed procedure step end time	(0040,0251)	sent with 0 length	sent with 0 length	Exam close time	Exam close time	No
Performed procedure step status	(0040,0252)	IN PROGRESS	IN PROGRESS	COMPLETED by default, DISCONTINUED is selected by the user at exam close.	COMPLETED by default, DISCONTINUED is selected by the user at exam close.	No
Performed procedure step ID	(0040,0253)	Automatically generated number by the Senographe Essential	Automatically generated number by the Senographe Essential	N/A	N/A	Yes
Performed procedure step description	(0040,0254)	MWL SCP data available in Study Description (0008,1030)	User entered	MWL SCP data available in Study Description (0008,1030)	User entered	Yes
Performed procedure type description	(0040,0255)	sent with 0 length	sent with 0 length	not sent	not sent	No
Performed protocol code sequence	(0040,0260)	sent with 0 length	sent with 0 length	not sent	not sent	No
Scheduled step attribute sequence	(0040,0270)	MWL SCP data	sent with 1 item	N/A	N/A	No
>Accession Number	(0008,0050)	MWL SCP data	User entered data	N/A	N/A	Yes
>Reference Study Sequence	(0008,1110)	MWL SCP data. If not present in MWL SCP data, sequence is not sent.	sent with 0 length	N/A	N/A	Yes
>>Referenced SOP Class UID	(0008,1150)	MWL SCP data	set to 1.2.840.10008.3.1.2.3.1	N/A	N/A	Yes

Attribute Name	Tag	N-Create		N-Set		Image Header
		Acquisition with MWL data	Acquisition without MWL data	Acquisition with MWL data	Acquisition without MWL data	
>>Referenced SOP Instance UID	(0008,1155)	MWL SCP data	Set to 0020,000D value	N/A	N/A	Yes
>Study Instance UID	(0020,000D)	MWL SCP	Generated study instance UID	N/A	N/A	Yes
>Requested Procedure description	(0032,1060)	MWL SCP data. If not present in MWL SCP data, attribute is sent with 0 length.	User entered	N/A	N/A	No
>Scheduled Procedure step description	(0040,0007)	MWL SCP data. If not present in MWL SCP data, attribute is sent with 0 length.	User entered	N/A	N/A	Yes
>Scheduled Protocol Code Sequence	(0040,0008)	MWL SCP. If not present in MWL SCP data, sequence is sent with 0 length.	sent with 0 length	N/A	N/A	Yes ***
>>Code Value	(0008,0100)	MWL SCP data	N/A	N/A	N/A	Yes***
>>Coding Scheme designator	(0008,0102)	MWL SCP data	N/A	N/A	N/A	Yes***
>>Code meaning	(0008,0104)	MWL SCP data	N/A	N/A	N/A	Yes***
>Scheduled procedure step ID	(0040,0009)	MWL SCP data	sent with 0 length	N/A	N/A	Yes
>Requested Procedure ID	(0040,1001)	MWL SCP data	sent with 0 length	N/A	N/A	Yes
Performed series sequence	(0040,0340)	sent with 0 length	sent with 0 length	sent with following values:	sent with following values:	No
>Retrieve AE title	(0008,0054)	N/A	N/A	sent with 0 length	sent with 0 length	No

Attribute Name	Tag	N-Create		N-Set		Image Header
		Acquisition with MWL data	Acquisition without MWL data	Acquisition with MWL data	Acquisition without MWL data	
>Protocol name	(0018,1030)	N/A	N/A	automatically set to ROUTINE, STEREO or CESM	automatically set to ROUTINE, STEREO, CESM or 3D_ROUTINE	Yes
>Series description	(0008,103E)	N/A	N/A	MWL SCP data available in Procedure Description (0040, 0007)	User entered	Yes
>Performing physician's name	(0008,1050)	N/A	N/A	MWL SCP data or user modified data	User entered	Yes
>Operator's name	(0008,1070)	N/A	N/A	User entered	User entered	Yes
>Referenced Image sequence	(0008,1140)	N/A	N/A	One item for each image generated by acquisition	One item for each image generated by acquisition	No
>>Referenced SOP Class UID	(0008,1150)	N/A	N/A	Image SOP class UID	Image SOP class UID	No
>>Referenced SOP Instance UID	(0008,1155)	N/A	N/A	Image SOP instance UID	Image SOP instance UID	No
>Series Instance UID	(0020,000E)	N/A	N/A	Generated series instance UID	Generated series instance UID	Yes
>Referenced Non-image composite SOP instance sequence	(0040,0220)	N/A	N/A	sent with 0 length	sent with 0 length	No
Total number of exposures	(0040,0301)	sent with 0 length	sent with 0 length	Sent with 0 length when referencing only Breast Tomosynthesis Image instances. Otherwise, value set to total number of exposures taken*	Sent with 0 length when referencing only Breast Tomosynthesis Image instances. Otherwise, value set to total number of exposures taken*	No

Attribute Name	Tag	N-Create		N-Set		Image Header
		Acquisition with MWL data	Acquisition without MWL data	Acquisition with MWL data	Acquisition without MWL data	
Organ dose **	(0040,0316)	sent with 0 length	sent with 0 length	overall average glandular dose delivered during the acquisition*. Sent with 0 length when referencing only Breast Tomosynthesis Image instances.	overall average glandular dose delivered during the acquisition*. Sent with 0 length when referencing only Breast Tomosynthesis Image instances.	No

* These values include images not sent automatically to the archiver/CAD.

** Organ dose is described in the MPPS SOP instances as a standard extended element.

*** Only described in the image SOP instance if data had been retrieved through MWL.

Revision History

Reference	Date	Main reason for change
5160041-2-100 rev.1	April 2006	Release for Senographe Essential Sirius M3. Based on Nephtys document 5160883-100 rev 1.
5160041-3-100 rev.1	October 2006	Release for Senographe Essential Sirius M3A plus. Based on Sirius M3 document 5160041-2-100 rev.1. <ul style="list-style-type: none"> Corrected description of "Detector Active Dimensions" and "Field of View Dimensions" attributes in Table 17 - DX DETECTOR MODULE ATTRIBUTES Removed "Field of View Dimensions" attribute from the Table of section 4.8 - Limitation summary Added "Detector Active Dimensions" attribute in the Table of section 4.8 - Limitation summary Corrected description of "View Modifier Code Sequence" attribute in Table 19 - DX POSITIONING MODULE ATTRIBUTES Corrected type (1C) of "Code Value", "Code Scheme descriptor" and "Code Meaning" attributes in Table 19 - DX POSITIONING MODULE ATTRIBUTES Deleted note from section 4.7 - Mammography View Codes
5160041-4-100 rev.1	June 2007	Release for Senographe Essential Sirius M41 (corresponds to Madras implementation). <ul style="list-style-type: none"> Occurrences of 1.2.840.113619.6.66 replaced by 1.2.840.113619.6.227 (this information was incorporated in the version 5160041-M-100_r1A060808 submitted for PMA) Inserted new SOP information in section 2-5-1 (Standard Extended /Specialized/Private SOPs). Corrected reference to DICOM standard in last cell of table in section 4-8 Corrected Key Type information in Table 7 in section 7-5-5-3 Added row (Scheduled Station Name) in Table 4, section 7-5-2-2 Added note relating to Organ Dose to Table 1 in section 11-2-1
5160041-5-100 rev.1	August 2007	Release for Senographe Essential Sirius M43 (corresponds to IS4-3). Based on 5160041-4-100 rev.1. <ul style="list-style-type: none"> Contrary to the previous release, specific to Senographe Essential with the U20 workstation, this current DCS is applicable to the product regardless of the type of ADS workstation (SB 150 or U20). Added attributes in Table 8 - General Equipment Module Attributes, section 4-5-4-1. Added and modified attributes in Table 9 - General Image Module Attributes, section 4-5-5-1. Added attribute in Table 10 - Image Pixel Module Attributes, section 4-5-5-2. Added attribute in Table 11 - X-Ray Acquisition Dose Module Attributes, section 4-5-5-3. Added attribute in Table 17 - DX Detector Module Attributes, section 4-5-5-9. Added attribute in Table 21 - Mammo Image Module Attributes, section 4-5-5-13.

Revision 1

DICOM CONFORMANCE STATEMENT 5415902-2-8EN

Revision History

Reference	Date	Main reason for change
5160041-6-100 rev.1	November 2007	Release for Senographe Essential Sirius M44 (corresponds to IS4-3 Forward Production). Based on 5160041-5-100 rev.1. <ul style="list-style-type: none"> Corrected attribute Organ Dose in Table 1 - MPPS USE OF DICOM DATA, section 11-2-1.
5160041-7-1EN rev.1	December 2008	Senographe Essential -Release for Kiwi M3 Step 1 <ul style="list-style-type: none"> Treated SPR EURge96160 by adding an explanation note on 4.8 paragraph Treated EURge93334 by adding an explanation note on page 35 Treated SPR XRYge80254 by changing the wording from 'Value comes from configuration file' into 5160041-4-100 version to 'Value comes from system configuration' into table 8 on page 50 Added a "Verification SCP" and "Verification SCU" note on 2.2.1 paragraph drawing Added a "CA-CANCEL", "C-FIND", "C-MOVE" note on 2-3-1-1-5-3-2 paragraph Added a "SOP instance" note on 2-3-1-1-6-1-2-1 paragraph Added a "Status code" note on 9-2-1-2-1-2 paragraph Added N-CREATE and N-SET table on 9-2-2-2-1-2 - 9-2-2-2-3-2 - 9-2-3-1-2-1-2 and 9-2-4-2-1-2
5160041-8-1EN rev.1	January 2010	Senographe Essential - Release for Penduick <ul style="list-style-type: none"> Added the "Language warning" section Added "MPPS SERVER AE: AE Title is set to SCU_hostname by default." on 2-6-1 Added the missing MG image entity diagram on 4-3 Corrected the Performed procedure step start date TAG from(0040, 243) to (0040,244) on 4-5-3-1 and 11-2 Added : "Values sent in this attribute are:0.094 (contact) 0.065 (mag 1.5) 0.055 (mag 1.8)" into "Imager Pixel Spacing" Attribute Description section 4.8 Added "Conformance Statement Overview" before Table of Content Changed sections 1.5 to 1.8 by applying the DCS Template Added the "Frame of reference Entity Modules" on section 4.5.74. Deleted the note on "8-3-1-1-1. General" Added the sentence "Image Type (0008,0008) is not copied in the DICOMDIR." on "3-3-1-2-3-1-1. Options:" section

Revision History

Reference	Date	Main reason for change
5160041-9-1EN rev.1	August 2010	<p>New DICOM for Senographe DS due to Gemini implementation:</p> <ul style="list-style-type: none"> Introduced the V4 (Z400) control station Changed the identification address for V1/V2 and V3/V4 control station where applicable: V1/V2 (SUN BLADE 150): 1.2.840.113619.6.66 to V1/V2 (SUN BLADE 150): 1.2.840.113619.6.254 V3 (U20): 1.2.840.113619.6.227 to V3 (U20)/V4 (Z400): 1.2.840.113619.6.255 Section 4-5-3-1, table 6, added the mention "Set to CESH for CESH exam" on "Protocol Name" attribute Section 4-5-4-1, adding "or CESH exams" to Frame of Reference module" explanation Section 4-5-6-1, table 10, adding "Value 4 is set to: HIGH_ENERGY or LOW_ENERGY or RECOMBINED" to the "Image type" attribute changed the "Referenced SOP Class UID" Description Changed the section 4-5-6-1-1-2 content Inserted the section 4-5-6-3 Contrast/Bolus Module attributes Section 4-5-6-3, table 12, substitute description of "Exposure" and "Exposure in μAs" with "Not in recombined images" Section 4-5-6-4, table 13 substitute description of "KVP", "Exposure Time" with "Not in recombined images" Section 4-5-6-5, table 14, substitute description of "Filter Type" with "Not in recombined images", and add "or COPPER. Not present in Recombined images" into "Filter Material" description Section 4-5-6-9, table 18, change "Image Pixel Spacing" description with "Set to 01./0.1" Section 4-5-7, table 25, delete "10" on Tag of "Clinical View" Changed description of "mu", "Threshold", "Breast ROI X", "Breast ROI Y", "Segm Threshold", "Premium View Beta" with "not present CESH Recombined images" Add a row about "Signal Average Factor" containing "0045,xxZZ; type 3; Attribute Description: only sent in CESH LOW_ENERGY and HIGH_ENERGY raw images (MG for Processing images)" Section 11-2-1, table 1, add "or CESH" into "N-Set" for "Protocol Name" Attribute
5415902-1-8EN rev. 1	February 2013	<p>Senographe Essential (DBT option)- Release for Aurora</p> <ul style="list-style-type: none"> Added DBT object related specifications Updated Manufacturer address
5415902-2-8EN rev. 1	October 2013	<p>Senographe Essential (DBT option)- Release for Aurora (Japan)</p> <ul style="list-style-type: none"> Reconstruction SW version update

Number	Size	Revision
5415902-2-8EN	A4	1

This page is intentionally left blank.

This page is intentionally left blank.

To contact your local GE representative, please go to:

<http://www.gehealthcare.com/helpcenter.html>

China Service Agent Address:

通用电气医疗系统贸易发展（上海）有限公司

（上海市外高桥保税区意威路 96 号 1 幢，邮编 200131）

Manufacturer and Manufacturing site:

GE MEDICAL SYSTEMS SCS

283 RUE DE LA MINIERE

78530 BUC

FRANCE

