



Technical Publications

Direction 2274502-100

Revision 0

***GENIE™ Acquisition R2.3.1, R2.3.2, R2.3.3* Conformance Statement for DICOM v3.0**

This document applies to the following systems:

Millennium MPR/MPS and MG

Optima NX

AC400

MAGICAM

g

GE Medical Systems

*GE Medical Systems: Telex 3797371
P.O. Box 414, Milwaukee, Wisconsin, 53201 U.S.A.
(Asia, Pacific, Latin America, North America)*

*GE Medical Systems – Europe: Telex 698626
283 rue de la Minière, B.P.34, 78533, Buc Cedex, France*

TABLE OF CONTENTS

1. INTRODUCTION	1-1
1.1 OVERVIEW	1-1
1.2 OVERALL DICOM CONFORMANCE STATEMENT DOCUMENT STRUCTURE.....	1-1
1.3 INTENDED AUDIENCE.....	1-3
1.4 SCOPE AND FIELD OF APPLICATION.....	1-3
1.5 IMPORTANT REMARKS.....	1-4
1.6 REFERENCES	1-5
1.7 DEFINITIONS.....	1-5
1.8 SYMBOLS AND ABBREVIATIONS.....	1-5
2. NETWORK CONFORMANCE STATEMENT.....	2-1
2.1 INTRODUCTION	2-1
2.2 IMPLEMENTATION MODEL.....	2-1
2.3 AE SPECIFICATIONS	2-3
2.4 COMMUNICATION PROFILES.....	2-10
2.5 EXTENSIONS / SPECIALIZATIONS / PRIVATIZATIONS	2-11
2.6 CONFIGURATION.....	2-11
2.7 SUPPORT OF EXTENDED CHARACTER SETS.....	2-12
3. NUCLEAR MEDICINE (NM) INFORMATION OBJECT IMPLEMENTATION.....	3-1
3.1 introduction.....	3-1
3.2 NM IOD Implementation	3-1
3.3 NM Entity-Relationship Model	3-1
3.4 IOD MODULE TABLE	3-3
3.5 INFORMATION MODULE DEFINITIONS	3-4
3.6 PRiVate data dictionary.....	3-24
4. PATIENT ROOT QUERY/RETRIEVE INFORMATION MODEL DEFINITION	4-1

4.1	introduction.....	4-1
4.2	Patient Root Information Model Description.....	4-1
4.3	Patient Root Information Model Entity-Relationship Model	4-1
4.4	INFORMATION Model Keys	4-3
4.5	PRIVate data dictionary.....	4-6
5.	STUDY ROOT QUERY/RETRIEVE INFORMATION MODEL DEFINITION.....	5-1
5.1	introduction.....	5-1
5.2	Study Root Information Model Description.....	5-1
5.3	Study Root Information Model Entity-Relationship Model	5-1
5.4	INFORMATION Model Keys	5-3
5.5	PRIVate data dictionary.....	5-5

LIST OF TABLES

TABLE 3.3-1 MAPPING OF DICOM ENTITIES TO GENIE ACQUISITION ENTITIES	3-3
TABLE 3.4-1 NM IMAGE IOD MODULES.....	3-4
TABLE 3.5-1 PATIENT MODULE ATTRIBUTES	3-5
TABLE 3.5-2 GENIE ACQUISITION PATIENT MODULE ATTRIBUTES	3-5
TABLE 3.5-3 GENERAL STUDY MODULE ATTRIBUTES	3-6
TABLE 3.5-4 PATIENTS STUDY MODULE ATTRIBUTES	3-6
TABLE 3.5-5 GENIE ACQUISITION STUDY MODULE ATTRIBUTES	3-7
TABLE 3.5-6 GENERAL SERIES MODULE ATTRIBUTES.....	3-7
TABLE 3.5-7 GENIE ACQUISITION SERIES MODULE ATTRIBUTES.....	3-8
TABLE 3.5-8 FRAME OF REFERENCE MODULE ATTRIBUTES.....	3-9
TABLE 3.5-9 GENERAL EQUIPMENT MODULE ATTRIBUTES.....	3-9
TABLE 3.5-10 GENERAL IMAGE MODULE ATTRIBUTES	3-10
TABLE 3.5-11 GENIE ACQUISITION IMAGE MODULE ATTRIBUTES	3-11
TABLE 3.5-12 IMAGE PIXEL MODULE ATTRIBUTES.....	3-12
TABLE 3.5-13 GENIE ACQUISITION IMAGE PIXEL MODULE ATTRIBUTES.....	3-12
TABLE 3.5-14 MULTI-FRAME MODULE ATTRIBUTES	3-13
TABLE 3.5-15 SOP COMMON MODULE ATTRIBUTES	3-13
TABLE 3.5-16 NM/PET PATIENT ORIENTATION MODULE ATTRIBUTES	3-14
TABLE 3.5-17 NM IMAGE PIXEL MODULE ATTRIBUTES	3-14
TABLE 3.5-18 NM MULTI-FRAME MODULE ATTRIBUTES.....	3-15
TABLE 3.5-19 ENUMERATED VALUES FOR FRAME INCREMENT POINTER.....	3-16
TABLE 3.5-20 NM IMAGE MODULE ATTRIBUTES.....	3-16
TABLE 3.5-21 NM ISOTOPE MODULE ATTRIBUTES.....	3-18
TABLE 3.5-22 GENIE ACQUISITION ISOTOPE MODULE ATTRIBUTES	3-19
TABLE 3.5-23 NM DETECTOR MODULE ATTRIBUTES	3-20
TABLE 3.5-24 GENIE ACQUISITION DETECTOR MODULE ATTRIBUTES	3-21
TABLE 3.5-25 NM TOMO ACQUISITION MODULE ATTRIBUTES	3-21
TABLE 3.5-26 GENIE ACQUISITION TOMO ACQUISITION MODULE ATTRIBUTES.....	3-22
TABLE 3.5-27 NM MULTI-GATED ACQUISITION MODULE ATTRIBUTES	3-22

TABLE 3.5-28 GENIE ACQUISITION MULTI-GATED ACQUISITION MODULE ATTRIBUTES 3-23

TABLE 3.5-29 NM PHASE MODULE ATTRIBUTES 3-23

TABLE 3.6-1 PRIVATE CREATOR IDENTIFICATION (GEMS_GENIE_1) 3-24

TABLE 4.3-1 MAPPING OF DICOM ENTITIES TO GENIE ACQUISITION ENTITIES 4-3

TABLE 4.4-1 PATIENT LEVEL ATTRIBUTES FOR THE PATIENT ROOT QUERY/RETRIEVE INFORMATION MODEL..... 4-4

TABLE 4.4-2 Q/R PATIENT LEVEL AND LOCATION FOR RETRIEVE ATTRIBUTES..... 4-4

TABLE 4.4-3 STUDY LEVEL ATTRIBUTES FOR THE PATIENT ROOT QUERY/RETRIEVE INFORMATION MODEL..... 4-4

TABLE 4.4-4 Q/R STUDY LEVEL AND LOCATION FOR RETRIEVE ATTRIBUTES..... 4-5

TABLE 4.4-5 SERIES LEVEL ATTRIBUTES FOR THE PATIENT ROOT QUERY/RETRIEVE INFORMATION MODEL 4-5

TABLE 4.4-6 Q/R SERIES LEVEL AND LOCATION FOR RETRIEVE ATTRIBUTES 4-5

TABLE 4.4-7 IMAGE LEVEL ATTRIBUTES FOR THE PATIENT ROOT QUERY/RETRIEVE INFORMATION MODEL 4-5

TABLE 4.4-8 Q/R IMAGE LEVEL AND LOCATION FOR RETRIEVE ATTRIBUTES 4-6

TABLE 5.3-1 MAPPING OF DICOM ENTITIES TO GENIE ACQUISITION ENTITIES 5-3

TABLE 5.4-1 STUDY LEVEL ATTRIBUTES FOR THE STUDY ROOT QUERY/RETRIEVE INFORMATION MODEL..... 5-4

TABLE 5.4-2 Q/R STUDY LEVEL AND LOCATION FOR RETRIEVE ATTRIBUTES..... 5-4

TABLE 5.4-3 SERIES LEVEL ATTRIBUTES FOR THE STUDY ROOT QUERY/RETRIEVE INFORMATION MODEL 5-4

TABLE 5.4-4 Q/R SERIES LEVEL AND LOCATION FOR RETRIEVE ATTRIBUTES 5-4

TABLE 5.4-5 IMAGE LEVEL ATTRIBUTES FOR THE STUDY ROOT QUERY/RETRIEVE INFORMATION MODEL 5-5

TABLE 5.4-6 Q/R IMAGE LEVEL AND LOCATION FOR RETRIEVE ATTRIBUTES 5-5

1. INTRODUCTION

1.1 OVERVIEW

This DICOM Conformance Statement is divided into Sections as described below:

Section 1 (Introduction), which describes the overall structure, intent, and references for this Conformance Statement

Section 2 (Network Conformance Statement), which specifies the GEMS equipment compliance to the DICOM requirements for the implementation of Networking features.

Section 3 (Nuclear Medicine Information Object Implementation), which specifies the GEMS equipment compliance to DICOM requirements for the implementation of a Nuclear Medicine Information Object.

1.2 OVERALL DICOM CONFORMANCE STATEMENT DOCUMENT STRUCTURE

The Documentation Structure of the GEMS Conformance Statements and their relationship with the DICOM v3.0 Conformance Statements is shown in the Illustration below.

ID/Net v3.0

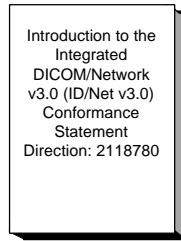

APPLICATION ENTITY SPECIFICATION (SERVICE CLASSES, INFORMATION OBJECTS, MESSAGE EXCHANGES, ETC.)

Product Implementation:

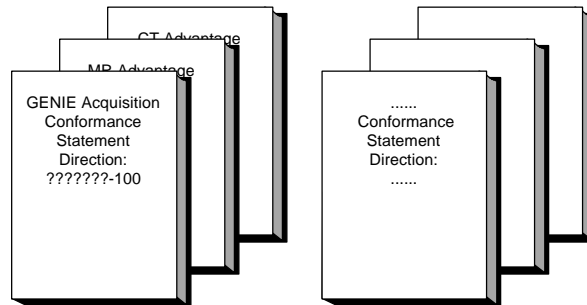

DICOM STANDARD

Standard Specification:

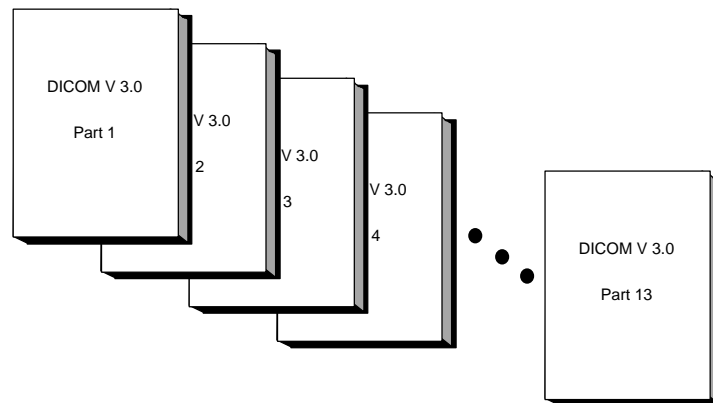

This document specifies the DICOM v3.0 implementation. It is entitled:

**GENIE™ Acquisition R2.3.1, R2.3.2, R2.3.3
Conformance Statement for DICOM v3.0
Direction 2274502-100**

This DICOM Conformance Statement documents the DICOM v3.0 Conformance Statement and Technical Specification required to interoperate with the GEMS network interface. Introductory information, which is applicable to all GEMS Conformance Statements, is described in the document:

*Introduction to the Integrated DICOM/Network v3.0 (ID/Net v3.0)
Conformance Statement
Direction: 2118780.*

This Introduction familiarizes the reader with DICOM terminology and general concepts. It should be read prior to reading the individual products' GEMS Conformance Statements.

The GEMS Conformance Statement, contained in this document, also specifies the Lower Layer communications which it supports (e.g., TCP/IP). However, the Technical Specifications are defined in the DICOM v3.0 Part 8 standard.

For more information including Network Architecture and basic DICOM concepts, please refer to the Introduction.

For more information regarding DICOM v3.0, copies of the Standard may be obtained by written request or phone by contacting:

NEMA Publication
1300 North 17th Street
Suite 1847
Rosslyn, VA 22209
USA
Phone: (703) 841-3200
Dat_Wall@nema.org

1.3 INTENDED AUDIENCE

The reader of this document is concerned with software design and/or system integration issues. It is assumed that the reader of this document is familiar with the DICOM v3.0 Standards and with the terminology and concepts which are used in those Standards.

If readers are unfamiliar with DICOM v3.0 terminology they should first refer to the document listed below, then read the DICOM v3.0 Standard itself, prior to reading this DICOM Conformance Statement document.

*Introduction to the Integrated DICOM/Network v3.0 (ID/Net v3.0)
Conformance Statement
Direction: 2118780*

1.4 SCOPE AND FIELD OF APPLICATION

It is the intent of this document, in conjunction with the *Introduction to the Integrated DICOM/Network v3.0 (ID/Net v3.0) Conformance Statement, Direction: 2118780*, to provide an unambiguous specification for GEMS implementations. This specification, called a Conformance Statement, includes a DICOM v3.0 Conformance Statement and is necessary to ensure proper processing and interpretation of GEMS medical data exchanged using DICOM v3.0. The GEMS Conformance Statements are available to the public.

The reader of this DICOM Conformance Statement should be aware that different GEMS devices are capable of using different Information Object Definitions. For example, a GEMS CT Scanner may send images using the CT Information Object, MR Information Object, Secondary Capture Object, etc.

Included in this DICOM Conformance Statement are the Module Definitions which define all data elements used by this GEMS implementation. If the user encounters unspecified private data elements while parsing a GEMS Data Set, the user is well advised to ignore those data elements (per the DICOM v3.0 standard). Unspecified private data element information is subject to change without notice. If, however, the device is acting as a "full fidelity storage device", it should retain and re-transmit all of the private data elements which are sent by GEMS devices.

1.5 IMPORTANT REMARKS

The use of these DICOM Conformance Statements, in conjunction with the DICOM v3.0 Standards, is intended to facilitate communication with GE imaging equipment. However, **by itself, it is not sufficient to ensure that inter-operation will be successful.** The **user (or user's agent)** needs to proceed with caution and address at least four issues:

- **Integration** - The integration of any device into an overall system of interconnected devices goes beyond the scope of standards (DICOM v3.0), and of this introduction and associated DICOM Conformance Statements when interoperability with non-GE equipment is desired. The responsibility to analyze the applications requirements and to design a solution that integrates GE imaging equipment with non-GE systems is the **user's** responsibility and should not be underestimated. The **user** is strongly advised to ensure that such an integration analysis is correctly performed.
- **Validation** - Testing the complete range of possible interactions between any GE device and non-GE devices, before the connection is declared operational, should not be overlooked. Therefore, the **user** should ensure that any non-GE provider accepts full responsibility for all validation required for their connection with GE devices. This includes the accuracy of the image data once it has crossed the interface between the GE imaging equipment and the non-GE device and the stability of the image data for the intended applications.

Such a validation is required before any clinical use (diagnosis and/or treatment) is performed. It applies when images acquired on GE imaging equipment are processed/displayed on a non-GE device, as well as when images acquired on non-GE equipment is processed/displayed on a GE console or workstation.

- **Future Evolution** - GE understands that the DICOM Standard will evolve to meet the user's growing requirements. GE is actively involved in the development of the DICOM v3.0 Standard. DICOM v3.0 will incorporate new features and technologies and GE may follow the evolution of the Standard. The GEMS protocol is based on DICOM v3.0 as specified in each ID/Net DICOM Conformance Statement. Evolution of the Standard may require changes to devices which have implemented DICOM v3.0. **In addition, GE reserves the right to discontinue or make changes to the support of communications features (on its products) reflected on by these ID/Net DICOM Conformance Statements.** The **user** should ensure that any non-GE provider, which connects with GE devices, also plans for the future evolution of the DICOM Standard. Failure to do so will likely result in the loss of function and/or connectivity as the DICOM Standard changes and GE Products are enhanced to support these changes.

- **Interaction** - It is the sole responsibility of the **non-GE provider** to ensure that communication with the interfaced equipment does not cause degradation of GE imaging equipment performance and/or function.

1.6 REFERENCES

A list of references which is applicable to all GEMS Conformance Statements is included in the *Introduction to the Integrated DICOM/Network v3.0 (ID/Net v3.0) Conformance Statement, Direction: 2118780*.

The information object implementation refers to DICOM PS 3.3 (Information Object Definition).

1.7 DEFINITIONS

A set of definitions which is applicable to all GEMS Conformance Statements is included in the *Introduction to the Integrated DICOM/Network v3.0 (ID/Net v3.0) Conformance Statement, Direction: 2118780*.

1.8 SYMBOLS AND ABBREVIATIONS

A list of symbols and abbreviations which is applicable to all GEMS Conformance Statements is included in the *Introduction to the Integrated DICOM/Network v3.0 (ID/Net v3.0) Conformance Statement, Direction: 2118780*.

This Page Intentionally Left Blank

2. NETWORK CONFORMANCE STATEMENT

2.1 INTRODUCTION

This section of the DICOM Conformance Statement specifies the compliance to DICOM conformance requirements for the relevant **Networking** features on this GEMS product. Note that the format of this section strictly follows the format defined in DICOM Standard PS 3.2 (Conformance). Please refer to that part of the standard while reading this section.

The GENIE Acquisition DICOM implementation allows the user to send Nuclear Medicine image data, acquired on GENIE Acquisition, to another DICOM station. For example, the user may wish to send data to a GENIE Processing and Review station in order to run the CEqual processing protocol. In this situation GENIE Acquisition is providing the DICOM C-STORE service as a service class user (SCU). GENIE Acquisition also allows query and retrieve of data stored in its local database from a remote station. In this situation GENIE Acquisition is providing the DICOM C-FIND and C-MOVE services as a service class provider (SCP).

The GENIE Acquisition DICOM implementation also provides a verification mechanism by which a remote application entity (AE) can verify application-level communication with the GENIE Acquisition DICOM Server. Also provided is a mechanism by which a GENIE Acquisition user can verify application-level communication with a remote DICOM AE. In these situations, GENIE Acquisition provides the DICOM C-ECHO service as both a SCP and SCU, respectively.

New in this implementation is the ability to configure GENIE Acquisition to send Image data in a variety of formats. These formats allow the GENIE Acq to send data to an Xpert P&R as well as to a GENIE P&R. For example, the Xpert P&R expects multigated tomo data as an image per energy set per detector whereas the GENIE P&R expects an image per bin per energy set per detector. GENIE Acq can be configured to apply uniformity and decay corrections to image data as part of the DICOM transfer.

2.2 IMPLEMENTATION MODEL

All DICOM functionality on the GENIE Acquisition product is logically provided by the DICOM Server AE. The DICOM Server AE is commanded to perform DICOM services through the use of the GENIE Acquisition user interface. The DICOM Server AE also listens on a pre-defined port for incoming connections from remote DICOM AEs.

2.2.1 Application Data Flow Diagram

The Basic and Specific Application models for this device are shown in the following Illustration :

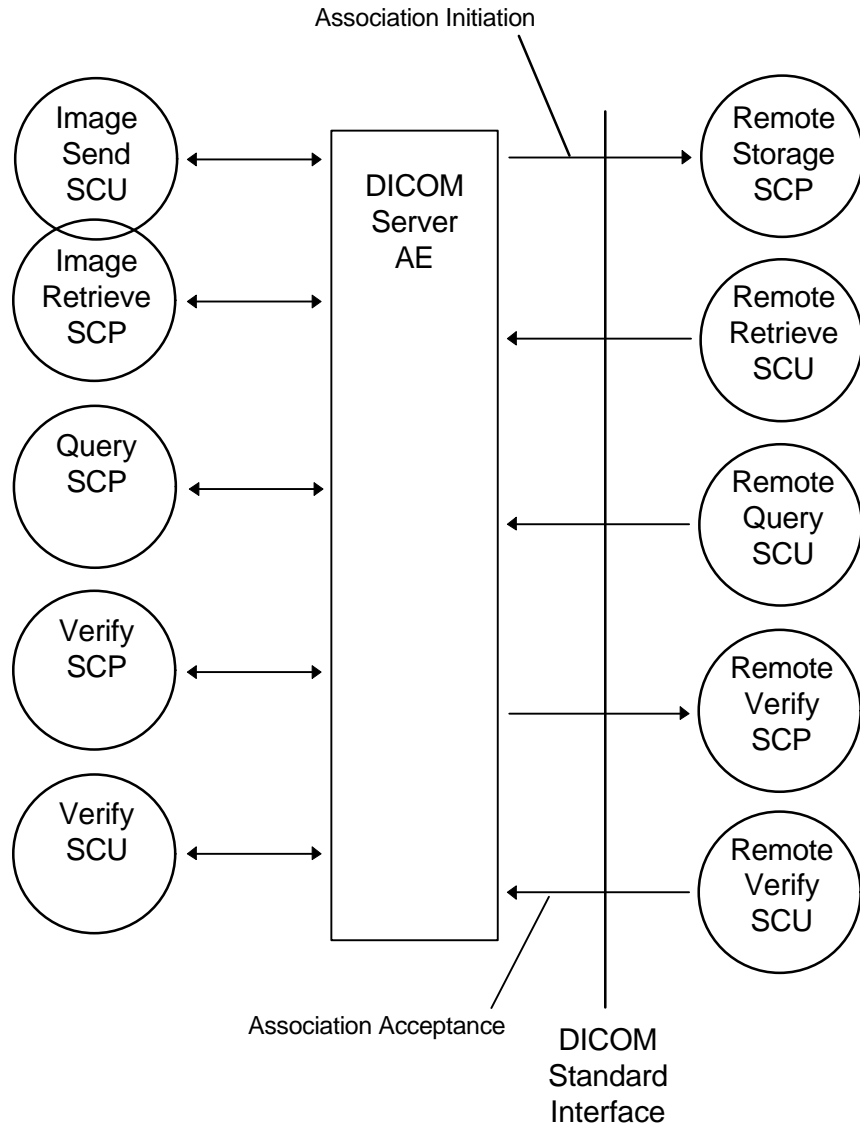

2.2.2 Functional Definition of AE's

The GENIE Acquisition DICOM Server AE initiates the following functions:

- *Store*: Initiates a DICOM association in order to send images to a remote AE. If the remote AE accepts a presentation context applicable to the image(s) being sent, the DICOM Server will send the images via the C-STORE service.
- *Verify*: Initiates a DICOM association in order to send a verification message to a remote AE via a C-ECHO-RQ message.

The GENIE Acquisition DICOM Server AE responds to the following functions:

- *Query*: Responds to incoming C-FIND-RQ messages by searching its local database for the requested attributes and returning a C-FIND-RSP message containing a match and a status of “pending.” All other matches are also returned in C-FIND-RSP messages with status of “pending” until the last message which is returned with a final status of “success”, “warning” or “failure”. The remote AE can terminate the query by sending a C-CANCEL-FIND-RQ message.
- *Retrieve*: Responds to incoming C-MOVE-RQ messages by searching its local database for the requested image(s) and returning each via a C-STORE-RQ message. The DICOM Server will return a C-FIND-RSP message after each image is sent. The status returned is “pending” until the last image is sent, in which case the appropriate status is returned. The remote AE can terminate the retrieve by sending a C-CANCEL-MOVE-RQ message.
- *Verify*: Responds to incoming C-ECHO-RQ messages by returning a C-ECHO-RSP message with a status of “success.”

2.2.3 Sequencing of Real-World Activities

Non Applicable.

2.3 AE SPECIFICATIONS

2.3.1 DICOM Server AE Specification

This Application Entity provides Standard Conformance to the following DICOM v3.0 SOP Classes as an SCU:

SOP Class Name	SOP Class UID
Nuclear Medicine Image Storage	1.2.840.10008.5.1.4.1.1.20
Verification - ECHO	1.2.840.10008.1.1

This Application Entity provides Standard Conformance to the following DICOM v3.0 SOP Classes as an SCP:

SOP Class Name	SOP Class UID
Patient Root Query/Retrieve Information Model - FIND	1.2.840.10008.5.1.4.1.2.1.1
Patient Root Query/Retrieve Information Model - MOVE	1.2.840.10008.5.1.4.1.2.1.2
Study Root Query/Retrieve Information Model - FIND	1.2.840.10008.5.1.4.1.2.2.1
Study Root Query/Retrieve Information Model - MOVE	1.2.840.10008.5.1.4.1.2.2.2
Verification - ECHO	1.2.840.10008.1.1

2.3.1.1 Association Establishment Policies

2.3.1.1.1 General

The DICOM Application Context Name (ACN), which is always proposed, is:

Application Context Name	1.2.840.10008.3.1.1.1
--------------------------	-----------------------

The Maximum Length PDU negotiation is included in all association establishment requests. The maximum length PDU for an association initiated by the DICOM Server is:

Maximum Length PDU	4 Kbytes
--------------------	----------

The SOP Class Extended Negotiation is not supported.

The maximum number of Presentation Context Items that will be proposed is 8. Note that the same Abstract Syntax may be offered multiple times with different Transfer Syntaxes.

The user information Items sent by this product are:

- Maximum PDU Length
- Implementation UID

2.3.1.1.2 Number of Associations

The DICOM Server AE (SCU) will initiate only one DICOM association at a time to perform an image store to a single remote AE. Up to two DICOM associations can be open to perform image store to different remote AEs.

The DICOM Server AE (SCP) can have a maximum of four DICOM associations open simultaneously to service queries, retrieves or verifications.

2.3.1.1.3 Asynchronous Nature

Asynchronous mode is not supported. All operations are performed synchronously.

2.3.1.1.4 Implementation Identifying Information

The Implementation UID for this DICOM v3.0 Implementation is:

GENIE Acquisition Implementation UID	1.2.840.113619.6.43
--------------------------------------	---------------------

2.3.1.2 Association Initiation Policy

The DICOM Server AE initiates a new association due to an image send operation being initiated from the GENIE Acquisition user interface or due to image data being retrieved. The DICOM Server AE also initiates a new association when the operator initiates a verification operation via the utility “DICOMping.”

2.3.1.2.1 Real-World Activity: Image Send

2.3.1.2.1.1 Associated Real-World Activity

The operator must both select image(s) to be transferred from the Patient Selector and select a destination from the Network Card. Once these selections have been made, the operator pushes the “Send” button to initiate an image send operation. The DICOM Server will then initiate an association with the remote AE in order to send the selected image(s).

A single association is used to send all data for a single destination.

2.3.1.2.1.2 Proposed Presentation Context Table

The following table shows the proposed presentation contexts for the DICOM Server AE after real-world activity “Image Send” has been initiated:

Presentation Context Table – Proposed					
Abstract Syntax		Transfer Syntax		Role	Extended Negotiation
Name	UID	Name List	UID List		
Nuclear Medicine Image Storage	1.2.840.10008.5.1.4.1.1.20	Implicit VR Little Endian	1.2.840.10008.1.2	SCU	None
		Explicit VR Little Endian	1.2.840.10008.1.2.1		
		Explicit VR Big Endian	1.2.840.10008.1.2.2		

2.3.1.2.1.2.1 SOP Specific DICOM Conformance Statement for all Storage SOP Classes

This implementation can perform multiple C-STORE operations over a single association.

Upon receiving a C-STORE confirmation containing a Successful status, this implementation will perform the next C-STORE operation. The association will be maintained if possible.

Upon receiving a C-STORE confirmation containing a Refused status, this implementation will terminate the association.

Upon receiving a C-STORE confirmation containing a status other than Successful or Refused, this implementation will consider the current request to be a failure but will continue to attempt to send any remaining images in the request using the same association.

Each C-STORE operation supports a configurable “Association Timer.” This timer starts when the association request is sent or received and stops when the association is established. The default time-out value is 10800 seconds on GENIE Acquisition R2.3.1, R2.3.2 and 60 seconds on GENIE Acquisition R2.3.3.

Each C-STORE operation supports a configurable “Session Timer.” This timer starts when an association is established and stops when the association is ended. The default time-out value is 10800 seconds on GENIE Acquisition R2.3.1, R2.3.2 and 7200 on GENIE Acquisition R2.3.3.

If any of the above timers expires, the association is closed and the operation in progress is considered to be failed.

Following are the status codes that are more specifically processed when receiving messages from **Storage SCP** equipment:

Service Status	Status Codes	Further Meaning	Application Behavior When receiving Status Codes
Refused	A7xx	Out of resources	The message “Image transfer failed” posted to the Log card.
	0122	SOP Class not Supported	The message “Image transfer failed” posted to the Log card.
Error	Cxxx	Cannot Understand	The message “Image transfer failed” posted to the Log card.
	A9xx	Data Set does not match SOP Class	The message “Image transfer failed” posted to the Log card.
Warning	B000	Coercion of Data Elements	The message “Successful; remote warning returned” posted to the network Log card.
	B007	Data Set does not match SOP Class	The message “Successful; remote warning returned” posted to the network Log card.
	B006	Elements Discarded	The message “Successful; remote warning returned” posted to the network Log card.
Success	0000		The message “Successful” posted to the network Log card.

2.3.1.2.2 Real-World Activity: Verify

2.3.1.2.2.1 Associated Real-World Activity

Service personnel invoke the utility “DICOMping” from the UNIX command line. The AE Title of the remote is supplied on the command line. The DICOM server will initiate an association with the remote DICOM AE in order to verify communication at the application level. The success or failure of the verification process is displayed to the user.

The IP and port number for the echo SCP is retrieved from a configuration file.

2.3.1.2.2.2 Proposed Presentation Context Table

Presentation Context Table - Proposed					
Abstract Syntax		Transfer Syntax		Role	Extended Negotiation
Name	UID	Name List	UID List		
Verification SOP Class	1.2.840.10008.1.1	Implicit VR Little Endian	1.2.840.10008.1.2	SCU	None

2.3.1.2.2.2.1 SOP Specific DICOM Conformance Statement for Verification SOP Class

The DICOM Server AE provides standard conformance to the DICOM Verification Service Class.

2.3.1.3 Association Acceptance Policy

The DICOM Server AE places no limitation on whom may connect to it.

The DICOM Server AE responds to queries from remote AE’s by returning matching entries. Any Remote AE can request and receive a list of images located in the local GENIE Acquisition database.

Any remote AE can open an association to the DICOM Server AE for the purpose of application level communication verification.

2.3.1.3.1 Real-World Activity: Query SCP

2.3.1.3.1.1 Associated Real-World Activity

The DICOM Server AE is always listening for associations. No operator action is required to respond to Query request.

The real-world activity associated with the Query request is to search the local database for all entries that match the request and send a C-FIND-RSP message with the status of “pending” for each matching entry. The exception to this is the last message which is sent with a status of “success”, “failure” or “refused”.

2.3.1.3.1.2 Accepted Presentation Context Table

Presentation Context Table – Accepted					
Abstract Syntax		Transfer Syntax		Role	Extended Negotiation
Name	UID	Name List	UID List		
Patient Root Query/Retrieve Information Model - FIND	1.2.840.10008.5.1.4.1.2.1.1	Implicit VR Little Endian	1.2.840.10008.1.2	SCP	None
		Explicit VR Little Endian	1.2.840.10008.1.2.1		
		Explicit VR Big Endian	1.2.840.10008.1.2.2		
Study Root Query/Retrieve Information Model - FIND	1.2.840.10008.5.1.4.1.2.2.1	Implicit VR Little Endian	1.2.840.10008.1.2	SCP	None
		Explicit VR Little Endian	1.2.840.10008.1.2.1		
		Explicit VR Big Endian	1.2.840.10008.1.2.2		

Note that this implementation does not support extended negotiation for the C-FIND Service, including that for relational-queries.

2.3.1.3.1.2.1 SOP Specific DICOM Conformance Statement for the Patient Root Query/Retrieve Information Model - FIND and Study Root Query/Retrieve Information Model - FIND SOP Classes

Following are the status codes the Application may send back to the SCU Equipment after performing the requested **Query** :

Service Status	Status Codes	Further Meaning	Application Behavior When receiving Status Codes
Refused	A700	Out of resources	

Failed	C000	Unable to process	Returned by the DICOM Server if for any other reason, not specified elsewhere in this table, the Find operation failed; error logged.
Cancel	FE00	Matching terminated due to cancel	Returned if the DICOM Server receives a C-CANCEL-FIND-RQ message; cancel logged.
Success	0000	Matching is complete - No final identifier is supplied	Returned when the DICOM Server completes the find operation.
Pending	FF00	Matches are continuing - Current Match is supplied and any Optional Keys were supported in the same manner as Required Keys.	
	FF01	Matches are continuing - Warning that one or more Optional Keys were not supported for existence and/or matching for this Identifier	

2.3.1.3.1.3 Presentation Context Acceptance Criterion

The Presentation Contexts that will be accepted by the DICOM Server will be the ones which the remote SCU has requested and that are supported by the GENIE Acquisition.

2.3.1.3.1.4 Transfer Syntax Selection Policies

In the case that multiple transfer syntaxes are requested for a single Presentation Context then GENIE Acquisition selects the one which is listed first in the accepted presentation context table specified above.

2.3.1.3.2 Real-World Activity: Image Retrieve SCP

2.3.1.3.2.1 Associated Real-World Activity

The DICOM Server AE is always listening for associations. No operator action is required to respond to an Image Retrieve request.

The real-world activity associated with the Image Retrieve request is to send all images corresponding to the C-MOVE request to the specified destination AE through a separate association.

2.3.1.3.2.2 Accepted Presentation Context Table

Presentation Context Table – Accepted					
Abstract Syntax		Transfer Syntax		Role	Extended Negotiation
Name	UID	Name List	UID List		
Patient Root Query/Retrieve Information Model - MOVE	1.2.840.10008.5.1.4.1.2.1.2	Implicit VR Little Endian	1.2.840.10008.1.2	SCP	None
		Explicit VR Little Endian	1.2.840.10008.1.2.1		
		Explicit VR Big Endian	1.2.840.10008.1.2.2		

Study Root Query/Retrieve Information Model - MOVE	1.2.840.10008.5.1.4.1.2.2. 2	Implicit VR Little Endian	1.2.840.10008.1.2	SCP	None
		Explicit VR Little Endian	1.2.840.10008.1.2.1		
		Explicit VR Big Endian	1.2.840.10008.1.2.2		

Note that this implementation does not support extended negotiation for the C-MOVE Service, including that for relational-retrieve.

2.3.1.3.2.2.1 SOP Specific DICOM Conformance Statement for the Patient Root Query/Retrieve Information Model - MOVE and Study Root Query/Retrieve Information Model - MOVE SOP Classes

Following are the status codes the Application may send back to the SCU Equipment after performing the requested **Retrieve** :

Service Status	Status Codes	Further Meaning	Application Behavior When receiving Status Codes
Refused	A701	Out of resources - Unable to calculate number of matches	
	A702	Out of resources - Unable to perform sub-operations	
	A801	Move Destination Unknown	Returned if the DICOM Server has no information on destination AE; error logged.
Failed	A900	Identifier does not match SOP Class	
	C000	Unable to process	Returned by the DICOM Server if for any other reason, not specified elsewhere in this table, the Find operation failed; error logged.
Cancel	FE00	Sub-operations terminated due to a Cancel indication	Returned if the DICOM Server receives a C-CANCEL-MOVE-RQ message.
Warning	B000	Sub-operations Complete - One or more Failures.	Returned upon completion if one or more of the specified images failed to transfer to the destination AE.
Success	0000	Sub-operations Complete - No Failure	Returned after the transfer of the last image.
Pending	FF00	Sub-operations are continuing	Returned after the transfer of each image except for the last.

2.3.1.3.3 Real-World Activity: Verify SCP

2.3.1.3.3.1 Associated Real-World Activity

The DICOM Server AE is always listening for associations. No operator action is required to respond to a Verification request.

The real-world activity associated with the Verification request is to send a C-ECHO-RSP message with a status of “success” to the requesting AE.

2.3.1.3.3.2 Accepted Presentation Context Table

Presentation Context Table - Accepted			
Abstract Syntax	Transfer Syntax	Role	Extended

Name	UID	Name List	UID List		Negotiation
Verification SOP Class	1.2.840.10008.1.1	Implicit VR Little Endian	1.2.840.10008.1.2	SCP	None

2.3.1.3.3.2.1 SOP Specific DICOM Conformance Statement for Verification SOP Class

The DICOM Server AE provides standard conformance to the DICOM verification service class.

2.3.1.3.3.3 Presentation Context Acceptance Criterion

The Presentation Contexts that will be accepted by the DICOM Server will be the ones which the remote SCU has requested and that are supported by the GENIE Acquisition.

2.3.1.3.3.4 Transfer Syntax Selection Policies

In the case that multiple transfer syntaxes are requested for a single Presentation Context then GENIE Acquisition selects the one which is listed first in the accepted presentation context table specified above.

2.4 COMMUNICATION PROFILES

2.4.1 Supported Communication Stacks (PS 3.8, PS 3.9)

DICOM Upper Layer (PS 3.8) is supported using TCP/IP.

2.4.2 OSI Stack

The OSI Communication Stack is not supported by this implementation.

2.4.3 TCP/IP Stack

The TCP/IP Communication Stack is inherited from the LynxOS real-time unix operating system.

2.4.3.1 API

Not applicable to this product.

2.4.3.2 Physical Media Support

Ethernet 802.3 provides the physical network layer for this product.

2.4.4 Point-to-Point Stack

The Point-to-Point Communication Stack is not supported by this implementation.

2.5 EXTENSIONS / SPECIALIZATIONS / PRIVATIZATIONS

2.5.1 Standard Extended /Specialized/Private SOPs

GENIE Acquisition implements the extended SOP class object NM IOD (see section 3).

2.5.2 Private Transfer Syntaxes

GENIE Acquisition does not implement any private transfer syntaxes.

2.6 CONFIGURATION

The GENIE Acquisition system is configured by GEMS Field Service Engineers. The DICOM configuration items below are configurable or re-configurable by a Field Service Engineer but are not accessible through the GENIE Acquisition user interface.

2.6.1 AE Title/Presentation Address Mapping

GENIE Acquisition allows for the configuration of the mapping of remote AE titles to IP addresses and ports. This configuration is performed by GEMS Field Service Engineers.

2.6.2 Configurable Parameters

The following parameters are configurable for the DICOM Server AE:

- Local AE Title (set to hostname of GENIE Acquisition computer)
- Local IP address
- Local IP netmask
- Local IP gateway

Note that the port on which GENIE Acquisition receives DICOM incoming TCP/IP connections is **2030**.

2.7 SUPPORT OF EXTENDED CHARACTER SETS

GENIE Acquisition will support only the ISO_IR 100 (ISO 8859-1:1987 Latin alphabet N 1. supplementary set) as extended character sets.

This Page Intentionally Left Blank

3. NUCLEAR MEDICINE (NM) INFORMATION OBJECT IMPLEMENTATION

3.1 INTRODUCTION

This section specifies the use of the DICOM NM Image IOD to represent the information included in NM images produced by this implementation. Corresponding attributes are conveyed using the module construct. The contents of this section are:

- 3.2 - IOD Description
- 3.3 - IOD Entity-Relationship Model
- 3.4 - IOD Module Table
- 3.5 - IOD Module Definition

3.2 NM IOD IMPLEMENTATION

The GENIE Acquisition implementation of DICOM uses the Nuclear Medicine multi-frame image format when creating image objects. In order to preserve full fidelity when transferring data to a GENIE Processing and Review station, some specialized database information is encoded as private DICOM attributes. The private data dictionary is included in section 3.6.

Note that the GENIE Acquisition DICOM implementation creates separate NM images (SOP instances) for each detector and energy window (energy set) in the acquisition.

3.3 NM ENTITY-RELATIONSHIP MODEL

The Entity-Relationship diagram for the NM Image interoperability schema is shown in Figure 3-1. In this figure, the following diagrammatic convention is established to represent the information organization :

- each entity is represented by a rectangular box.
- each relationship is represented by a diamond shaped box.
- the fact that a relationship exists between two entities is depicted by lines connecting the corresponding entity boxes to the relationship boxes.

The relationships are fully defined with the maximum number of possible entities in the relationship shown. In other words, the relationship between Series and Image can have up to n Images per Series, but the Patient to Study relationship has 1 Study for each Patient (a Patient can have more than one Study on the system, however, each Study will contain information pertaining to that one Patient).

FIGURE 3-1
 NM IMAGE ENTITY RELATIONSHIP DIAGRAM

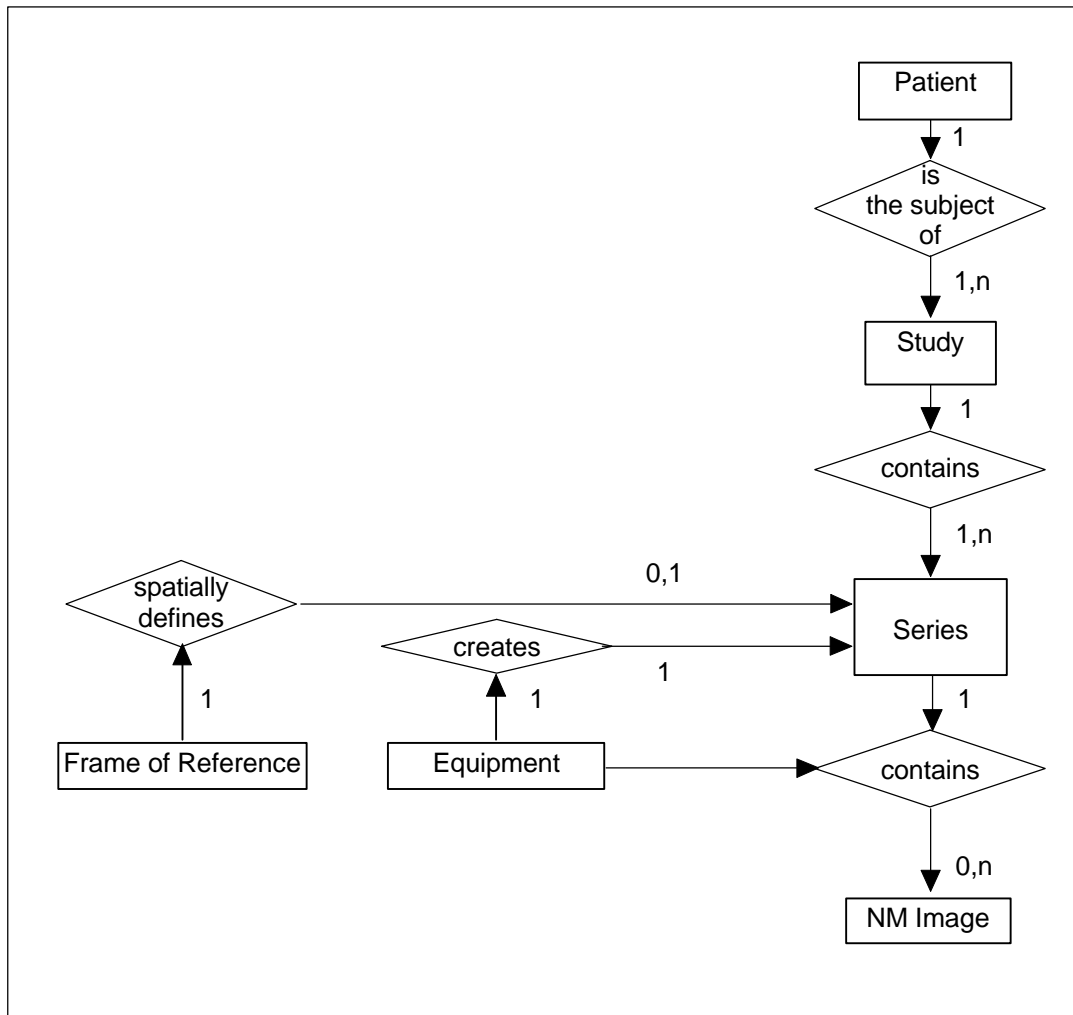

3.3.1 ENTITY DESCRIPTIONS

Please refer to DICOM Standard Part 3 (Information Object Definitions) for a description of each of the entities contained within the NM Information Object.

3.3.1.1 Patient Entity Description

The Patient Entity defines the characteristics of a patient who is the subject of one or more medical studies which produce medical images.

3.3.1.2 Study Entity Description

The Study Entity defines the characteristics of a medical study performed on a patient. A study is a collection of one or more series of medical images which are logically related for the purpose of diagnosing a patient. Each study is associated with exactly one patient.

3.3.1.3 Series Entity Description

The Series Entity defines the attributes which are used to group images into distinct logical sets. Each series is associated with exactly one study.

3.3.1.4 Equipment Entity Description

The Equipment Entity describes the particular imaging device which produced the series of images. An imaging device may produce one or more series within a study. The Equipment Entity does not describe the data acquisition or image creation Attributes used to generate images within a series.

3.3.1.5 Frame of Reference Entity Description

The Frame of Reference Entity identifies the coordinate system which conveys spatial and/or temporal information of images in a series.

3.3.1.6 NM Image Entity Description

The NM Image Entity defines the attributes which describe the pixel data of a NM image. The pixel data is generated on GENIE Acquisition as a direct result of patient scanning (an Original image). An image is defined by its image plane, pixel data characteristics, gray scale and/or color mapping characteristics and modality specific characteristics (acquisition parameters and image creation information).

3.3.2 GENIE Acquisition Mapping of DICOM entities

TABLE 3.3-1
MAPPING OF DICOM ENTITIES TO GENIE ACQUISITION ENTITIES

DICOM	GENIE Acquisition Entity
Patient	Patient
Study	Study
Series	Series
Image	Imageset
Frame	Not Applicable

3.4 IOD MODULE TABLE

Within an entity of the DICOM v3.0 NM IOD, attributes are grouped into related sets of attributes. A set of related attributes is termed a module. A module facilitates the understanding of the semantics concerning the attributes and how the attributes are related to each other. A module grouping does not infer any encoding of information into datasets.

Table 3.4-1 identifies the defined modules within the entities which comprise the DICOM v3.0 NM IOD. Modules are identified by Module Name.

Please refer to the DICOM v3.0 Standard Part 3 for a complete definition of the entities, modules, and attributes.

TABLE 3.4-1
NM IMAGE IOD MODULES

Entity Name	Module Name	Reference
Patient	Patient	3.5.1.1
	GENIE Acquisition Patient	3.5.1.2
Study	General Study	3.5.2.1
	Patient Study	3.5.2.2
	GENIE Acquisition Study	3.5.2.3
Series	General Series	3.5.3.1
	NM Series	3.5.8.1
	GENIE Acquisition Series	3.5.3.2
Frame of Reference	Frame of Reference	3.5.4.1
Equipment	General Equipment	3.5.5.1
Image	General Image	3.5.6.1
	GENIE Acquisition Image	3.5.6.2
	Image Pixel	3.5.6.3
	NM Image Pixel	3.5.8.2
	GENIE Acquisition Image Pixel	3.5.6.4
	Multi-frame	3.5.6.5
	NM Multi-frame	3.5.8.3
	NM Image	3.5.8.4
	NM Isotope	3.5.8.5
	GENIE Acquisition Isotope	3.5.8.6
	NM Detector	3.5.8.7
	GENIE Acquisition Detector	3.5.8.8
	NM TOMO Acquisition	3.5.8.9
	GENIE Acquisition TOMO Acquisition	3.5.8.10
	NM Multi-gated Acquisition	3.5.8.11
GENIE Acquisition Multi-gated Acquisition	3.5.8.12	
NM Phase	3.5.8.13	
SOP Common	3.5.7.1	

3.5 INFORMATION MODULE DEFINITIONS

Please refer to the DICOM v3.0 Standard Part 3 (Information Object Definitions) for a description of each of the entities and modules contained within the NM Information Object.

The following modules are included to convey Enumerated Values, Defined Terms, and Optional Attributes supported. Type 1 & Type 2 Attributes are also included for completeness and to define what values they may take and where these values are obtained from. It should be noted that they are the same as those defined in the DICOM v3.0 Standard Part 3 (Information Object Definitions).

3.5.1 Common Patient Entity Modules

3.5.1.1 Patient Module

This section specifies the Attributes of the patient that describe and identify the patient who is the subject of a diagnostic Study. This Module contains Attributes of the patient that are needed for diagnostic interpretation of the Image and are common for all studies performed on the patient.

TABLE 3.5-1
 PATIENT MODULE ATTRIBUTES

Attribute Name	Tag	Type	Attribute Description
Patient's Name	(0010,0010)	2	Entered on To Do card, Patient Name field. Name is not sent with PN VR individual component values.
Patient ID	(0010,0020)	2	Entered on To Do card, Patient ID field.
Patient's Birth Date	(0010,0030)	2	Entered on Patient card, Date Of Birth field.
Patient's Sex	(0010,0040)	2	Entered on Patient card, Sex selection.
Referenced Patient Sequence	(0008,1120)	3	Not used.
>Referenced SOP Class UID	(0008,1150)	1C	Not used.
>Referenced SOP Instance UID	(0008,1155)	1C	Not used.
Patient's Birth Time	(0010,0032)	3	Not used.
Other Patient IDs	(0010,1000)	3	Entered on Patient card, Other Ids field.
Other Patient Names	(0010,1001)	3	Entered on Patient card, Other Names field.
Ethnic Group	(0010,2160)	3	Entered on Patient card, Ethnic Group field.
Patient Comments	(0010,4000)	3	Entered on Patient card, Comments field.

3.5.1.2 GENIE Acquisition Patient Module

This section specifies the Attributes of the patient that describe and identify the patient who is the subject of a diagnostic Study. This Module contains *private* Attributes that convey information not contained in similar DICOM Standard v3.0 Module(s).

TABLE 3.5-2
 GENIE ACQUISITION PATIENT MODULE ATTRIBUTES

Attribute Name	Tag	Type	Attribute Description
Patient Flags	(0009,xx41)	3	Defines patient information.
Patient Creation Date	(0009,xx42)	3	Date of Patient Entity creation.
Patient Creation Time	(0009,xx43)	3	Time of Patient Entity creation.

3.5.2 Common Study Entity Modules

The following Study IE Modules are common to all Composite Image IODs which reference the Study IE. These Module contain Attributes of the patient and study that are needed for diagnostic interpretation of the image.

3.5.2.1 General Study Module

This section specifies the Attributes which describe and identify the study performed upon the patient.

TABLE 3.5-3
GENERAL STUDY MODULE ATTRIBUTES

Attribute Name	Tag	Type	Attribute Description
Study Instance UID	(0020,000D)	1	Internally generated.
Study Date	(0008,0020)	2	Creation date of study entity (yyyymmdd).
Study Time	(0008,0030)	2	Creation time of study entity (hhmmss).
Referring Physician's Name	(0008,0090)	2	Entered on Patient card, Referring Phys field.
Study ID	(0020,0010)	2	Entered on Patient card, Processing Tag field.
Accession Number	(0008,0050)	2	Not used.
Study Description	(0008,1030)	3	Entered on To Do card, Study Name field.
Physician(s) of Record	(0008,1048)	3	Not used.
Name of Physician(s) Reading Study	(0008,1060)	3	Entered on Patient card, Reading Phys field.
Referenced Study Sequence	(0008,1110)	3	Not used.
>Referenced SOP Class UID	(0008,1150)	1C	Not used.
>Referenced SOP Instance UID	(0008,1155)	1C	Not used.

3.5.2.2 Patient Study Module

This section defines Attributes that provide information about the Patient at the time the Study was performed.

TABLE 3.5-4
PATIENTS STUDY MODULE ATTRIBUTES

Attribute Name	Tag	Type	Attribute Description
Admitting Diagnoses Description	(0008,1080)	3	Not used.
Patient's Age	(0010,1010)	3	Entered on Patient card, Age field.
Patient's Size	(0010,1020)	3	Entered on Patient card, Height field.
Patient's Weight	(0010,1030)	3	Entered on Patient card, Weight field.
Occupation	(0010,2180)	3	Entered on Patient card, Occupation field.
Additional Patient's History	(0010,21B0)	3	Entered on Patient card, History field.

3.5.2.3 GENIE Acquisition Study Module

This section specifies the Attributes which describe and identify the Study performed upon the Patient. This Module contains *private* Attributes that convey information not contained in similar DICOM Standard v3.0 Module(s).

TABLE 3.5-5
GENIE ACQUISITION STUDY MODULE ATTRIBUTES

Attribute Name	Tag	Type	Attribute Description
Study Flags	(0009,xx11)	3	Defines study information.
Study Type	(0009,xx12)	3	Defines type of study.
Study Comments	(0013,xx26)	3	User-defined additional information about the study.

3.5.3 Common Series Entity Modules

The following Series IE Modules are common to all Composite Image IODs which reference the Series IE.

3.5.3.1 General Series Module

This section specifies the Attributes which identify and describe general information about the Series within a Study.

TABLE 3.5-6
GENERAL SERIES MODULE ATTRIBUTES

Attribute Name	Tag	Type	Attribute Description
Modality	(0008,0060)	1	Internally set to "NM".
Series Instance UID	(0020,000E)	1	Internally generated.
Series Number	(0020,0011)	2	Internally generated.
Laterality	(0020,0060)	2C	Entered on Image card; sent if present.
Series Date	(0008,0021)	3	Date of acquisition completion.
Series Time	(0008,0031)	3	Time of acquisition completion.
Performing Physicians' Name	(0008,1050)	3	Not used.
Protocol Name	(0018,1030)	3	Entered on To Do card, Study Name field.
Series Description	(0008,103E)	3	Entered on To Do card, Series Name field.
Operators' Name	(0008,1070)	3	Not used.
Referenced Study Component Sequence	(0008,1111)	3	Not used.
>Referenced SOP Class UID	(0008,1150)	1C	Not used.
>Referenced SOP Instance UID	(0008,1155)	1C	Not used.
Body Part Examined	(0018,0015)	3	Entered on Image card, Part field.
Patient Position	(0018,5100)	2C	Entered on Image card, Position selection The Defined Terms are: HFP = Head First-Prone HFS = Head First-Supine HFDR = Head First-Decubitus Right HFDL = Head First-Decubitus Left FFDR = Feet First-Decubitus Right FFDL = Feet First-Decubitus Left FFP = Feet First-Prone FFS = Feet First-Supine
Smallest Pixel Value in Series	(0028,0108)	3	Not used (see Image Pixel module).

Largest Pixel Value in Series	(0028,0109)	3	Not used (see Image Pixel module).
-------------------------------	-------------	---	------------------------------------

3.5.3.2 GENIE Acquisition Series Module

This section specifies the Attributes which identify and describe general information about the Series within a Study. This Module contains *private* Attributes that convey information not contained in similar DICOM Standard v3.0 Module(s).

TABLE 3.5-7
GENIE ACQUISITION SERIES MODULE ATTRIBUTES

Attribute Name	Tag	Type	Attribute Description
Series Flags	(0009,xx21)	3	Defines series information.
User Orientation	(0009,xx22)	3	User specified patient orientation.
Initiation Type	(0009,xx23)	3	Acquisition initiation type. The Defined Terms are: 0 = started on count rate 1 = started after time delay 2 = started manually
Initiation Delay	(0009,xx24)	3	Acquisition start delay time.
Initiation Count Rate	(0009,xx25)	3	Acquisition start count rate
Number Energy Sets	(0009,xx26)	3	Number of energy sets (windows).
Number Detectors	(0009,xx27)	3	Number of detectors.
Series Comments	(0009,xx2C)	3	User-defined additional information about the series.
Distance Prescribed	(0009,xx2E)	3	User prescribed whole body scanning distance.
Series Type	(0011,xx0A)	3	Defines type of series. The Defined Terms are: 0 = static 1 = whole body 3 = multi-gated 6 = dynamic 9 = tomographic
Effective Series Duration	(0011,xx0B)	3	Duration of series acquisition.
Number Beats	(0011,xx0C)	3	Number of physiological triggers during acquisition.

3.5.4 Common Frame Of Reference Entity Modules

The following Frame of Reference IE Module is common to all Composite Image IODs which reference the Frame of Reference IE.

3.5.4.1 Frame Of Reference Module

This section specifies the Attributes necessary to uniquely identify a Frame Of Reference which insures the spatial relationship of Images within a Series. It also allows Images across multiple Series to share the same Frame Of Reference. This Frame Of Reference (or coordinate system) shall be constant for all Images related to a specific Frame Of Reference.

GENIE Acquisition groups spatially and/or temporally related Images in the same Series. Although multiple Series in a Study may be spatially and/or temporally related, this implementation does not convey this information.

TABLE 3.5-8
FRAME OF REFERENCE MODULE ATTRIBUTES

Attribute Name	Tag	Type	Attribute Description
Frame of Reference UID	(0020,0052)	1	See 3.5.4.1.1.1 for further explanation.
Position Reference Indicator	(0020,1040)	2	See 3.5.4.1.1.2 for further explanation.

3.5.4.1.1 Frame Of Reference Attribute Descriptions

3.5.4.1.1.1 Frame Of Reference UID

The Frame Of Reference UID is set to a value unique to every Series. This is done because images of a given series are assumed to be spatially and/or temporally related.

3.5.4.1.1.2 Position Reference Indicator

The Position Reference Indicator (0020,1040) is used to specify the part of the patient's anatomy which was used as an anatomical reference point associated with a specific Frame of Reference UID. The value of the Position Reference Indicator is entered on the Image card, "Ref:" field.

3.5.5 Common Equipment Entity Modules

The following Equipment IE Module is common to all Composite Image IODs which reference the Equipment IE.

3.5.5.1 General Equipment Module

This section specifies the Attributes which identify and describe the piece of equipment which produced a Series of Images.

TABLE 3.5-9
GENERAL EQUIPMENT MODULE ATTRIBUTES

Attribute Name	Tag	Type	Attribute Description
Manufacturer	(0008,0070)	2	Set to "GE MEDICAL SYSTEMS".
Institution Name	(0008,0080)	3	Set to value displayed on user interface banner.
Institution Address	(0008,0081)	3	Not used.
Station Name	(0008,1010)	3	Set to the name of station data acquired on.
Institutional Department Name	(0008,1040)	3	Not used.

Manufacturer's Model Name	(0008,1090)	3	Set to system type data acquired on.
Device Serial Number	(0018,1000)	3	Set to serial number data acquired on.
Software Versions	(0018,1020)	3	Set to GENIE Acquisition software version.
Spatial Resolution	(0018,1050)	3	Not used.
Date of Last Calibration	(0018,1200)	3	Not used.
Time of Last Calibration	(0018,1201)	3	Not used.
Pixel Padding Value	(0028,0120)	3	Not used.

3.5.6 Common Image Entity Modules

The following Image IE Modules are common to all Composite Image IODs which reference the Image IE.

3.5.6.1 General Image Module

This section specifies the Attributes which identify and describe an image within a particular series.

TABLE 3.5-10
GENERAL IMAGE MODULE ATTRIBUTES

Attribute Name	Tag	Type	Attribute Description
Image Number	(0020,0013)	2	Internally generated.
Patient Orientation	(0020,0020)	2C	Not used.
Image Date	(0008,0023)	2C	Date of acquisition completion (yyyymmdd).
Image Time	(0008,0033)	2C	Time of acquisition completion (hhmmss).
Image Type	(0008,0008)	3	See NM Image module.
Acquisition Number	(0020,0012)	3	Not used.
Acquisition Date	(0008,0022)	3	Date of acquisition completion.
Acquisition Time	(0008,0032)	3	Time of acquisition completion.
Referenced Image Sequence	(0008,1140)	3	Images from the same series acquired by the same detector
>Referenced SOP Class UID	(0008,1150)	1C	Set to "1.2.840.10008.5.1.4.1.1.20", Nuclear Medicine Image Storage SOP Class UID.
>Referenced SOP Instance UID	(0008,1155)	1C	Internally generated.
Derivation Description	(0008,2111)	3	Not used.
Source Image Sequence	(0008,2112)	3	Not used..
>Referenced SOP Class UID	(0008,1150)	1C	Not used.
>Referenced SOP Instance UID	(0008,1155)	1C	Not used.
Images in Acquisition	(0020,1002)	3	Number of images in the series
Image Comments	(0020,4000)	3	Not used.
Lossy Image Compression	(0028,2110)	3	Not used. Images are never compressed.

3.5.6.2 GENIE Acquisition Image Module

This section specifies the Attributes which identify and describe an image within a particular series. This Module contains *private* Attributes that convey information not contained in similar DICOM Standard v3.0 Module(s).

TABLE 3.5-11
GENIE ACQUISITION IMAGE MODULE ATTRIBUTES

Attribute Name	Tag	Type	Attribute Description
Radio Nuclide Name	(0011,xx0D)	3	Name of radionuclide used.
Dataset Name	(0011,xx12)	3	Name of imageset in Starlink or Xpert format.
Dataset Type	(0011,xx13)	3	Defines type of dataset. The Defined Terms are: 0 = static 2 = whole body 8 = dynamic 11 = multi-gated 12 = tomographic planar
Detector Number	(0011,xx15)	3	Detector number image was acquired by.
Energy Number	(0011,xx16)	3	Energy set number.
RR Interval Window Number	(0011,xx17)	3	R-R interval number (TIAR number).
MG Bin Number	(0011,xx18)	3	Multi-gated interval number.
Radius Of Rotation	(0011,xx19)	3	Distance to the center of detector rotation.
Detector Count Zone	(0011,xx1A)	3	FOV zone for count-based acquisition termination criteria. The Defined Terms are: 0 = none specified 1 = total (all) counts 2 = counts in energy set 3 = counts inside an ROI 4 = counts outside an ROI
Num Energy Windows	(0011,xx1B)	3	Number of energy windows in energy set.
Image Orientation	(0011,xx1F)	3	Orientation of the image. The Defined Terms are: 0 = no rotation, no mirroring 1 = no rotation, mirrored
Table Orientation	(0011,xx26)	3	Orientation of the table for whole body acquisition. The Defined Terms are: 0 = direction in/out 1 = direction left/right
ROI Top Left	(0011,xx27)	3	Acquisition count zone ROI, top left coordinate.
ROI Bottom Right	(0011,xx28)	3	Acquisition count zone ROI, bottom right coordinate.
Energy Correct Name	(0011,xx33)	3	Name of applied energy correction.
Spatial Correct Name	(0011,xx34)	3	Name of applied spatial correction.
Tuning Calib Name	(0011,xx35)	3	Name of applied tuning calibration data.
Uniformity Correct Name	(0011,xx36)	3	Name of associated uniformity correction.
Acquisition Specific Correct Name	(0011,xx37)	3	Name(s) of associated acquisition specific correction(s).
Dataset Flags	(0011,xx3F)	3	Defines dataset information.
Period	(0011,xx55)	3	Set to 1.0.
Elapsed Time	(0011,xx56)	3	Set to 1.0.

Digital FOV	(0011,xx10)	3	Field-of-view size.
-------------	-------------	---	---------------------

3.5.6.3 Image Pixel Module

This section specifies the Attributes that describe the pixel data of the image.

TABLE 3.5-12
IMAGE PIXEL MODULE ATTRIBUTES

Attribute Name	Tag	Type	Attribute Description
Samples per Pixel	(0028,0002)	1	See NM Image Pixel module.
Photometric Interpretation	(0028,0004)	1	See NM Image Pixel module.
Rows	(0028,0010)	1	Will be one of the following values: 64, 128, 256, 512, 1024.
Columns	(0028,0011)	1	Will be one of the following values: 64, 128, 256, 512.
Bits Allocated	(0028,0100)	1	See NM Image Pixel module.
Bits Stored	(0028,0101)	1	See NM Image Pixel module.
High Bit	(0028,0102)	1	See NM Image Pixel module.
Pixel Representation	(0028,0103)	1	Set to 0001H (2's complement).
Pixel Data	(7FE0,0010)	1	Acquired NM count data.
Planar Configuration	(0028,0006)	1C	Not used. Attribute not required since Samples per Pixel (0028,0002) is always 1.
Pixel Aspect Ratio	(0028,0034)	1C	Not used. Attribute not required since aspect ratio is always 1\1.
Smallest Image Pixel Value	(0028,0106)	3	Set to minimum pixel value in image.
Largest Image Pixel Value	(0028,0107)	3	Set to maximum pixel value in image.
Red Palette Color Lookup Table Descriptor	(0028,1101)	1C	Not used.
Green Palette Color Lookup Table Descriptor	(0028,1102)	1C	Not used.
Blue Palette Color Lookup Table Descriptor	(0028,1103)	1C	Not used.
Red Palette Color Lookup Table Data	(0028,1201)	1C	Not used.
Green Palette Color Lookup Table Data	(0028,1202)	1C	Not used.
Blue Palette Color Lookup Table Data	(0028,1203)	1C	Not used.

3.5.6.4 GENIE Acquisition Image Pixel Module

This section specifies the Attributes that describe the pixel data of the image. This Module contains *private* Attributes that convey information not contained in similar DICOM Standard v3.0 Module(s).

TABLE 3.5-13
GENIE ACQUISITION IMAGE PIXEL MODULE ATTRIBUTES

Attribute Name	Tag	Type	Attribute Description
Byte Order	(0011,xx38)	3	Defines pixel data byte order. The Defined Terms are: = little endian 66 = big endian

Picture Format	(0011,xx3A)	3	Set to 5 (GENIE IAP image format).
Pixel Scale	(0011,xx3B)	3	Set to 1.0.
Pixel Offset	(0011,xx3C)	3	Set to 0.0.
Threshold Center	(0011,xx44)	3	Set to 2048.0.
Threshold Width	(0011,xx45)	3	Set to 4096.0.
Interpolation Type	(0011,xx38)	3	Set to 2.

3.5.6.5 Multi-Frame Module

This section specifies the Attributes of a Multi-frame pixel data Image.

TABLE 3.5-14
MULTI-FRAME MODULE ATTRIBUTES

Attribute Name	Tag	Type	Attribute Description
Number of Frames	(0028,0008)	1	Set to total number of frames in image.
Frame Increment Pointer	(0028,0009)	1	See 3.5.6.5.1.1 for further explanation.

3.5.6.5.1 Multi-Frame Attribute Descriptions

3.5.6.5.1.1 Frame Increment Pointer

See the NM Multi-frame Module for further information.

3.5.7 General Modules

The SOP Common Module is mandatory for all DICOM IODs.

3.5.7.1 SOP Common Module

This section defines the Attributes which are required for proper functioning and identification of the associated SOP Instances. They do not specify any semantics about the Real-World Object represented by the IOD.

TABLE 3.5-15
SOP COMMON MODULE ATTRIBUTES

Attribute Name	Tag	Type	Attribute Description
SOP Class UID	(0008,0016)	1	Set to “1.2.840.10008.5.1.4.1.1.20”, Nuclear Medicine Image Storage SOP Class UID.
SOP Instance UID	(0008,0018)	1	Internally generated.
Specific Character Set	(0008,0005)	1C	“ISO_IR 100”.
Instance Creation Date	(0008,0012)	3	Date of instance creation.

Instance Creation Time	(0008,0013)	3	Time of instance creation.
Instance Creator UID	(0008,0014)	3	Not used.

3.5.8 Nuclear Medicine Modules

This Section describes Nuclear Medicine Series, and Image Modules. These Modules contain Attributes that are specific to the NM Image IOD.

Note that more than one SOP Instance can be used to encode a single NM acquisition. For example, for Multi-gated Tomographic acquisitions, the data for each gate is sent in a separate SOP Instance as a separate Multi-gated Tomographic image. It is valid for the receiving AE to recombine the SOP Instances, per the structure of the NM IOD, to form a new SOP Instance.

3.5.8.1 NM/PET Patient Orientation Module

This section specifies the Attributes that describe the NM Series.

TABLE 3.5-16
NM/PET PATIENT ORIENTATION MODULE ATTRIBUTES

Attribute Name	Tag	Type	Attribute Description
Patient Orientation Code Sequence	(0054,0410)	2	Not used.
> Code Value	(0008,0100)	1C	Not used.
> Coding Scheme Designator	(0008,0102)	1C	Not used.
> Code Meaning	(0008,0104)	3	Not used.
> Patient Orientation Modifier Code Sequence	(0054,0412)	2C	Not used.
>> Code value	(0008,0100)	1C	Not used.
>> Coding Scheme Designator	(0008,0102)	1C	Not used.
>> Code Meaning	(0008,0104)	3	Not used.
Patient Gantry Relationship Code Sequence	(0054,0414)	2	Not used.
> Code Value	(0008,0100)	1C	Not used.
> Coding Scheme Designator	(0008,0102)	1C	Not used..
> Code Meaning	(0008,0104)	3	Not used.

3.5.8.2 NM Image Pixel Module

This section specifies the Attributes that describe the pixel data of a NM image.

TABLE 3.5-17
NM IMAGE PIXEL MODULE ATTRIBUTES

Attribute Name	Tag	Type	Attribute Description
Samples per Pixel	(0028,0002)	1	Set to 1.
Photometric Interpretation	(0028,0004)	1	Set to Enumerated Value MONOCHROME2.

Bits Allocated	(0028,0100)	1	Set to 16.
Bits Stored	(0028,0101)	1	Set to 16.
High Bit	(0028,0102)	1	Set to 15.
Pixel Spacing	(0028,0030)	2	Set to size of pixels in image.

3.5.8.3 NM Multi-frame Module

This section specifies the Attributes of a NM Multi-frame Image. This module is always included in a NM SOP instance, even if there is only one frame in the image.

TABLE 3.5-18
NM MULTI-FRAME MODULE ATTRIBUTES

Attribute Name	Tag	Type	Attribute Description
Frame Increment Pointer	(0028,0009)	1	See 3.5.8.3.1.1 for further specialization.
Energy Window Vector	(0054,0010)	1C	Defines energy window to which each frame belongs.
Number of Energy Windows	(0054,0011)	1	Set to number of energy windows in SOP Instance.
Detector Vector	(0054,0020)	1C	All indices set to 1.
Number of Detectors	(0054,0021)	1	Set to 1.
Phase Vector	(0054,0030)	1C	Defines phases to which each frame belongs.
Number of Phases	(0054,0031)	1C	Set to number of phase in SOP Instance.
Rotation Vector	(0054,0050)	1C	All indices set to 1.
Number of Rotations	(0054,0051)	1C	Set to 1.
R-R Interval Vector	(0054,0060)	1C	All indices set to 1.
Number of R-R Intervals	(0054,0061)	1C	Set to 1.
Time Slot Vector	(0054,0070)	1C	Defines time slot, within cardiac cycle, to which each frame belongs.
Number of Time Slots	(0054,0071)	1C	Set to number of time slots in SOP Instance.
Slice Vector	(0054,0080)	1C	All indices set to 1.
Number of Slices	(0054,0081)	1C	Set to 1.
Angular View Vector	(0054,0090)	1C	Defines angular view number to which each frame belongs.
Time Slice Vector	(0054,0100)	1C	Defines frame numbers within each phase.

3.5.8.3.1 NM Multi-Frame Attribute Descriptions

3.5.8.3.1.1 Frame Increment Pointer

The Frame Increment Pointer (0028,0009) defines which frame index vectors are present in the NM Multi-frame Module. Not all frame index vectors are present for each image type. The Frame Increment Pointer is supported per the DICOM specification for all image types defined in Table 3.5-19.

TABLE 3.5-19
ENUMERATED VALUES FOR FRAME INCREMENT POINTER

Image Type (0008,0008), Value 3	Frame Increment Pointer (0028,0009)
STATIC or WHOLE BODY	0054H 0010H \ 0054H 0020H Sequencing is by Energy Window Vector (0054,0010), Detector Vector (0054,0020).
DYNAMIC	0054H 0010H \ 0054H 0020H \ 0054H 0030H \ 0054H 0100H Sequencing is by Energy Window Vector (0054,0010), Detector Vector (0054,0020), Phase Vector (0054,0030), Time Slice Vector (0054,0100)
GATED	0054H 0010H \ 0054H 0020H \ 0054H 0060H \ 0054H 0070H Sequencing is by Energy Window Vector (0054,0010), Detector Vector (0054,0020), R-R Interval Vector(0054,0060), Time Slot Vector (0054,0070)
TOMO	0054H 0010H \ 0054H 0020H \ 0054H 0050H \ 0054H 0090H Sequencing is by Energy Window Vector (0054,0010), Detector Vector (0054,0020), Rotation Vector (0054,0050), Angular View Vector (0054,0090)
GATED TOMO	0054H 0010H \ 0054H 0020H \ 0054H 0050H \ 0054H 0060H \ 0054H 0070H \ 0054H 0090H Sequencing is by Energy Window Vector (0054,0010), Detector Vector (0054,0020), Rotation Vector (0054,0050), R-R Interval Vector (0054,0060), Time Slot Vector (0054,0070), Angular View Vector (0054,0090).

3.5.8.4 NM Image Module

This section contains the Attributes that describe Nuclear Medicine Images.

TABLE 3.5-20
NM IMAGE MODULE ATTRIBUTES

Attribute Name	Tag	Type	Attribute Description
Image Type	(0008,0008)	1	See 3.5.8.4.1.1 for specialization.
Image ID	(0054,0400)	3	Set to name of imageset.
Lossy Image Compression	(0028,2110)	1C	Not used. Images never compressed.
Counts Accumulated	(0018,0070)	2	Set to number of counts in imageset.
Acquisition Termination Condition	(0018,0071)	3	Defined Terms used: CNTS = count limit reached DENS = count limit reached within ROI MANU = manual TIME = time limit reached TRIG = number of beats limit reached
Table Height	(0018,1130)	3	Height of table above floor at acquisition start.

Table Traverse	(0018,1131)	3	Table longitudinal position at acquisition start.
Actual Frame Duration	(0018,1242)	1C	Duration of each frame in imageset.
Count Rate	(0018,1243)	3	Maximum count rate during image acquisition.
Processing Function	(0018,5020)	3	Not used.
Corrected Image	(0028,0051)	3	Defined Terms used: NRGY = energy corrected LIN = linearity corrected UNIF = uniformity corrected COR = centre of rotation corrected DECAY = decay corrected
Whole Body Technique	(0018,1301)	3	Enumerated Values used: IPS = one pass
Scan Velocity	(0018,1300)	2C	Whole body scan speed
Scan Length	(0018,1302)	2C	Whole body scan length
Referenced Overlay Sequence	(0008,1130)	3	Not used.
>Referenced SOP Class UID	(0008,1150)	1C	Not used.
>Referenced SOP Instance UID	(0008,1155)	1C	Not used.
Referenced Curve Sequence	(0008,1145)	3	Not used.
>Referenced SOP Class UID	(0008,1150)	1C	Not used.
>Referenced SOP Instance UID	(0008,1155)	1C	Not used.
Trigger Source or Type	(0018,1061)	3	Defined Terms used: EKG
Anatomic Region Sequence	(0008,2218)	3	Not used.
> Code Value	(0008,0100)	1C	Not used.
> Coding Scheme Designator	(0008,0102)	1C	Not used.
> Code Meaning	(0008,0104)	3	Not used.
> Anatomic Region Modifier Sequence	(0008,2220)	3	Not used.
>> Code Value	(0008,0100)	1C	Not used.
>> Coding Scheme Designator	(0008,0102)	1C	Not used.
>> Code Meaning	(0008,0104)	3	Not used.
Primary Anatomic Structure Sequence	(0008,2228)	3	Not used.
> Code Value	(0008,0100)	1C	Not used.
> Coding Scheme Designator	(0008,0102)	1C	Not used.
> Code Meaning	(0008,0104)	3	Not used.
> Primary Anatomic Structure Modifier Sequence	(0008,2230)	3	Not used.
>> Code Value	(0008,0100)	1C	Not used.
>> Coding Scheme Designator	(0008,0102)	1C	Not used.
>> Code Meaning	(0008,0104)	3	Not used.

3.5.8.4.1 NM Image Module Attribute Descriptions

3.5.8.4.1.1 Image Type

The following Image Type (0008,0008) values are sent:

- Value 1 shall have the following Enumerated Value:
 - ORIGINAL identifies an Original Image
- Value 2 shall have the following Enumerated Value:
 - PRIMARY identifies a Primary Image
- Value 3 shall have the following Enumerated Values:
 - STATIC identifies a Static Image
 - DYNAMIC identifies a Dynamic Image
 - GATED identifies a Multi-gated Image
 - WHOLE BODY identifies a Whole Body Image
 - TOMO identifies a Tomographic Image
 - GATED TOMO identifies a Multi-gated Tomographic Image
- Value 4 shall have the following Enumerated Values:
 - EMISSION transmission source NOT active during image acquisition
 - TRANSMISSION transmission source active during image acquisition

3.5.8.5 NM Isotope Module

This section contains Attributes that describe the isotope administered for the acquisition.

TABLE 3.5-21
NM ISOTOPE MODULE ATTRIBUTES

Attribute Name	Tag	Type	Attribute Description
Energy Window Information Sequence	(0054,0012)	2	Energy window information.
> Energy Window Name	(0054,0018)	3	Entered on Energy Set N card, Emission Name and/or Transmission Name field.
>Energy Window Range Sequence	(0054,0013)	3	Sequence describing window energy limits.
>> Energy Window Lower Limit	(0054,0014)	3	Lower energy limit in KeV.
>> Energy Window Upper Limit	(0054,0015)	3	Upper energy limit in KeV.
Radiopharmaceutical Information Sequence	(0054,0016)	2	Information on radiopharmaceutical(s) used.
> Radionuclide Code Sequence	(0054,0300)	2C	Not used (Zero length).
>> Code Value	(0008,0100)	1C	Not used.
>> Coding Scheme Designator	(0008,0102)	1C	Not used.
>> Code Meaning	(0008,0104)	3	Not used.
> Radiopharmaceutical Route	(0018,1070)	3	Not used.
> Administration Route Code Sequence	(0054,0302)	3	Not used.
>> Code Value	(0008,0100)	1C	Not used.
>> Coding Scheme Designator	(0008,0102)	1C	Not used.
>> Code Meaning	(0008,0104)	3	Not used.
> Radiopharmaceutical Volume	(0018,1071)	3	Entered on Energy Isotope card, Nuclide Vol field.
> Radiopharmaceutical Start Time	(0018,1072)	3	Not used.
> Radiopharmaceutical Stop Time	(0018,1073)	3	Not used.
> Radionuclide Total Dose	(0018,1074)	3	Entered on Energy Isotope card, Total Dose field.

> Calibration Data Sequence	(0054,0306)	3	Dose information.
>> Energy Window Number	(0054,0308)	1C	Set to 1.
>> Syringe Counts	(0018,1045)	3	Entered on Energy Isotope card, Dose field.
>> Residual Syringe Counts	(0054,0017)	3	Entered on Energy Isotope card, Residual Dose field.
> Radiopharmaceutical	(0018,0031)	3	Entered on Energy Isotope card, Pharm field.
> Radiopharmaceutical Code Sequence	(0054,0304)	3	Not used.
>> Code Value	(0008,0100)	1C	Not used.
>> Coding Scheme Designator	(0008,0102)	1C	Not used.
>> Code Meaning	(0008,0104)	3	Not used.
Intervention Drug Information Sequence	(0018,0026)	3	Not used.
>Intervention Drug Name	(0018,0034)	3	Not used.
>Intervention Drug Code Sequence	(0018,0029)	3	Not used.
>> Code Value	(0008,0100)	1C	Not used.
>> Coding Scheme Designator	(0008,0102)	1C	Not used.
>> Code Meaning	(0008,0104)	3	Not used.
> Administration Route Code Sequence	(0054,0302)	3	Not used.
>> Code Value	(0008,0100)	1C	Not used.
>> Coding Scheme Designator	(0008,0102)	1C	Not used.
>> Code Meaning	(0008,0104)	3	Not used.
>Intervention Drug Start Time	(0018,0035)	3	Not used.
>Intervention Drug Stop Time	(0018,0027)	3	Not used.
>Intervention Drug Dose	(0018,0028)	3	Not used.

3.5.8.6 GENIE Acquisition Isotope Module

This section contains Attributes that describe the isotope administered for the acquisition. This Module contains *private* Attributes that convey information not contained in similar DICOM Standard v3.0 Module(s).

TABLE 3.5-22
GENIE ACQUISITION ISOTOPE MODULE ATTRIBUTES

Attribute Name	Tag	Type	Attribute Description
Energy Offset	(0011,xx1C)	3	Energy window offset as a percentage of the energy peak.
Energy Range	(0011,xx1D)	3	Defines X-series detector energy range. The Defined Terms are: 0 = low energy range 1 = high energy range
AutoTrack Peak	(0013,xx16)	3	Optima AutoTrack energy peak.
AutoTrack Width	(0013,xx17)	3	Optima AutoTrack energy width.

3.5.8.7 NM Detector Module

This section contains IOD Attributes that describe Nuclear Medicine Detectors used to produce an image.

TABLE 3.5-23
NM DETECTOR MODULE ATTRIBUTES

Attribute Name	Tag	Type	Attribute Description
Detector Information Sequence	(0054,0022)	2	Detector information.
> Collimator/Grid Name	(0018,1180)	3	Name of collimator used on this detector.
> Collimator Type	(0018,1181)	2C	Which Defined Terms used: PARA = Parallel PINH = Pinhole FANB = Fan-beam CONE = Cone-beam SLNT = Slant hole ASTG = Astigmatic DIVG = Diverging NONE = No collimator UNKN = Unknown
> Field of View Shape	(0018,1147)	3	Which Defined Terms used: RECTANGLE ROUND HEXAGONAL
> Field of View Dimension(s)	(0018,1149)	3	Dimensions of the field of view.
> Focal Distance	(0018,1182)	2C	Focal distance.
> X Focus Center	(0018,1183)	3	Center point of the focus position.
> Y Focus Center	(0018,1184)	3	Center point of the focus position.
> Zoom Center	(0028,0032)	3	Image center offset from field of view center.
> Zoom Factor	(0028,0031)	3	Zoom factor, typical range: 1.00 to 4.00.
> Center of Rotation Offset	(0018,1145)	3	Offset between detector center and mechanical center positions.
> Gantry/Detector Tilt	(0018,1120)	3	Detector tilt position.
> Distance Source to Detector	(0018,1110)	2C	Distance between transmission source and detector during transmission scanning.
> Start Angle	(0054,0200)	3	Not used.
> Radial Position	(0018,1142)	3	Detector radial position at start of acquisition.
> Image Orientation (Patient)	(0020,0037)	2C	Set to 1.0\0.0\0.0\0.0\1.0\0.0.
> Image Position (Patient)	(0020,0032)	2C	Set to 0.0\0.0\0.0.
> View Code Sequence	(0054,0220)	3	Not used.
>> Code Value	(0008,0100)	1C	Not used.
>> Coding Scheme Designator	(0008,0102)	1C	Not used.
>> Code Meaning	(0008,0104)	3	Not used.
>>> View Angulation Modifier Code Sequence	(0054,0222)	2C	Not used.
>>>> Code value	(0008,0100)	1C	Not used.
>>>> Coding Scheme Designator	(0008,0102)	1C	Not used.
>>>> Code Meaning	(0008,0104)	3	Not used.

3.5.8.8 GENIE Acquisition Detector Module

This section contains Attributes that describe Nuclear Medicine Detectors used to produce an image. This Module contains *private* Attributes that convey information not contained in similar DICOM Standard v3.0 Module(s).

TABLE 3.5-24
GENIE ACQUISITION DETECTOR MODULE ATTRIBUTES

Attribute Name	Tag	Type	Attribute Description
Use FOV Mask	(0011,xx23)	3	Whether FOV mask used during image acquisition. The Defined Terms are: 0 = no mask used 1 = FOV mask used
FOV Mask Y Cutoff Distance	(0011,xx24)	3	Hexagonal FOV mask Y cutoff angle.
FOV Mask Cutoff Angle	(0011,xx25)	3	Hexagonal FOV mask cutoff angle.
FOV Shape	(0011,xx3E)	3	GEMS NM system detector type. The Defined Terms are: 1 = 400AC 6 = Optima 7 = MAXXUS 8 = Millennium MPS 9 = Millennium MPR 10 = Millennium MG
Transmission Scan Time	(0013,xx18)	3	Attenuation correction transmission scan duration.
Transmission Mask Width	(0013,xx19)	3	Attenuation correction transmission scan mask width.
Copper Attenuator Thickness	(0013,xx1A)	3	Thickness of transmission scan copper attenuator.

3.5.8.9 NM TOMO Acquisition Module

This section contains Attributes that describe Rotation information of a tomographic image performed on the patient. This module is present when the Image Type (0008,0008) Value 3, is equal to TOMO or GATED TOMO.

TABLE 3.5-25
NM TOMO ACQUISITION MODULE ATTRIBUTES

Attribute Name	Tag	Type	Attribute Description
Rotation Information Sequence	(0054,0052)	2	Provides TOMO rotation information.
> Start Angle	(0054,0200)	1C	Detector start angle at start of acquisition.
> Angular Step	(0018,1144)	1C	Incremental rotational angle change per view.
> Rotation Direction	(0018,1140)	1C	Direction of rotation.
> Scan Arc	(0018,1143)	1C	Total rotation angle.
> Actual Frame Duration	(0018,1242)	1C	Duration of a view.
> Radial Position	(0018,1142)	3	Detector radial position at start of acquisition.
> Distance Source to Detector	(0018,1110)	2C	Distance between transmission source and detector during transmission scanning.
> Number of Frames in Rotation	(0054,0053)	1C	Number of tomographic views acquired.
> Table Traverse	(0018,1131)	3	Table longitudinal position at acquisition start.
> Table Height	(0018,1130)	3	Height of table above floor at acquisition start.

Type of Detector Motion	(0054,0202)	3	Enumerated Values used: STEP AND SHOOT = Interrupted motion, acquire only while stationary. CONTINUOUS = Gantry motion and acquisition are simultaneous and continuous. ACQ DURING STEP = Interrupted motion, acquisition is continuous.
-------------------------	-------------	---	---

3.5.8.10 GENIE Acquisition TOMO Acquisition Module

This section contains Attributes that describe Rotation information of a tomographic acquisition image performed on the patient. This Module contains *private* Attributes that convey information not contained in similar DICOM Standard v3.0 Module(s).

TABLE 3.5-26
GENIE ACQUISITION TOMO ACQUISITION MODULE ATTRIBUTES

Attribute Name	Tag	Type	Attribute Description
Gantry Locus Type	(0009,xx35)	3	Locus type of gantry motion during acquisition. The Defined Terms are: 0 = circular 1 = elliptical
Tomo View Offset	(0013,xx1E)	3	Table of offsets from COR during acquisition.

3.5.8.11 NM Multi-gated Acquisition Module

This section contains Attributes that describe a multi-gated acquisition performed on the patient. This refers to frames acquired while the patient is connected to a gating device. This module is present when the Image Type (0008,0008) Value 3, is equal to GATED or GATED TOMO.

TABLE 3.5-27
NM MULTI-GATED ACQUISITION MODULE ATTRIBUTES

Attribute Name	Tag	Type	Attribute Description
Beat Rejection Flag	(0018,1080)	3	Whether a bad beat rejection algorithm used. Enumerated values: Y = bad beat rejection algorithm used N = bad beat rejection algorithm NOT used
PVC Rejection	(0018,1085)	3	Set to "AMGB buffered beats with single acceptance window".
Skip Beats	(0018,1086)	3	Set to 1.
Heart Rate	(0018,1088)	3	Average heart rate during acquisition.
Gated Information Sequence	(0054,0062)	2C	One sequence item present.
> Trigger Time	(0018,1060)	3	Not used.
> Framing Type	(0018,1064)	3	Not used.
> Data Information Sequence	(0054,0063)	2C	One sequence item present.

>> Frame Time	(0018,1063)	1C	Gated frame duration in the imageset.
>> Nominal Interval	(0018,1062)	3	Not used.
>> Low R-R Value	(0018,1081)	3	Minimum R-R interval value accepted.
>> High R-R Value	(0018,1082)	3	Maximum R-R interval value accepted.
>> Intervals Acquired	(0018,1083)	3	Number of accepted intervals.
>> Intervals Rejected	(0018,1084)	3	Number of rejected intervals.
>> Time Slot Information Sequence	(0054,0072)	2C	Not used.
>>> Time Slot Time	(0054,0073)	3	Not used.

3.5.8.12 GENIE Acquisition Multi-gated Acquisition Module

This section contains Attributes that describe a multi-gated acquisition performed on the patient. This refers to frames acquired while the patient is connected to a gating device. This Module contains *private* Attributes that convey information not contained in similar DICOM Standard v3.0 Module(s).

TABLE 3.5-28
GENIE ACQUISITION MULTI-GATED ACQUISITION MODULE ATTRIBUTES

Attribute Name	Tag	Type	Attribute Description
Starting Heart Rate	(0009,xx37)	3	Heart rate at start of acquisition.
Track Beat Average	(0009,xx2D)	3	Whether heart rate tracking used during acquisition.
RR Window Width	(0009,xx38)	3	Width of RR acceptance window as percentage of rate.
RR Window Offset	(0009,xx39)	3	Offset of RR acceptance window as percentage of rate.
Percent Cycle Imaged	(0009,xx3A)	3	Percentage of RR cycle imaged.

3.5.8.13 NM Phase Module

This section contains Attributes that describe dynamic phases of a dynamic acquisition image performed on the patient. This module is present when the Image Type (0008,0008) Value 3, is equal to DYNAMIC.

TABLE 3.5-29
NM PHASE MODULE ATTRIBUTES

Attribute Name	Tag	Type	Attribute Description
Phase Information Sequence	(0054,0032)	2C	One sequence item per dynamic phase.
> Phase Delay	(0054,0036)	1C	Set to 0.
> Actual Frame Duration	(0018,1242)	1C	Duration of all frames in this phase.
> Pause Between Frames	(0054,0038)	1C	Set to 0.
> Number of Frames in Phase	(0054,0033)	1C	Number of frames in this phase.
>Trigger Vector	(0054,0210)	3	A string of the form "T1\T2\T3\...\..."
>Number of Triggers in Phase	(0054,0211)	1C	Number of triggers in this phase

3.6 PRIVATE DATA DICTIONARY

This section provides value representation and multiplicity information for all of the Private Attributes used by this implementation. Private Attributes contained within the Information Model are described in the preceding sections.

TABLE 3.6-1
PRIVATE CREATOR IDENTIFICATION (GEMS_GENIE_1)

Attribute Name	Tag	VR	VM
Private Creator Identification	(0009,0010)	LO	1
Study Flags	(0009,xx11)	SL	1
Study Type	(0009,xx12)	SL	1
Series Flags	(0009,xx21)	SL	1
User Orientation	(0009,xx22)	SH	1
Initiation Type	(0009,xx23)	SL	1
Initiation Delay	(0009,xx24)	SL	1
Initiation Count Rate	(0009,xx25)	SL	1
Number Energy Sets	(0009,xx26)	SL	1
Number Detectors	(0009,xx27)	SL	1
Series Comments	(0009,xx2C)	LO	1
Track Beat Average	(0009,xx2D)	SL	1
Distance Prescribed	(0009,xx2E)	FD	1
Gantry Locus Type	(0009,xx35)	SL	1
Starting Heart Rate	(0009,xx37)	SL	1
RR Window Width	(0009,xx38)	SL	1
RR Window Offset	(0009,xx39)	SL	1
Percent Cycle Imaged	(0009,xx3A)	SL	1
Patient Flags	(0009,xx41)	SL	1
Patient Creation Date	(0009,xx42)	DA	1
Patient Creation Time	(0009,xx43)	TM	1
Private Creator Identification	(0011,0010)	LO	1
Series Type	(0011,xx0A)	SL	1
Effective Series Duration	(0011,xx0B)	SL	1
Num Beats	(0011,xx0C)	SL	1
Radio Nuclide Name	(0011,xx0D)	LO	1
Dataset Name	(0011,xx12)	LO	1
Dataset Type	(0011,xx13)	SL	1
Detector Number	(0011,xx15)	SL	1
Energy Number	(0011,xx16)	SL	1
RR Interval Window Number	(0011,xx17)	SL	1
MG Bin Number	(0011,xx18)	SL	1
Radius Of Rotation	(0011,xx19)	FD	1
Detector Count Zone	(0011,xx1A)	SL	1
Num Energy Windows	(0011,xx1B)	SL	1
Energy Offset	(0011,xx1C)	SL	4

Energy Range	(0011,xx1D)	SL	1
Image Orientation	(0011,xx1F)	SL	1
Use FOV Mask	(0011,xx23)	SL	1
FOV Mask Y Cutoff Angle	(0011,xx24)	SL	1
FOV Mask Cutoff Angle	(0011,xx25)	SL	1
Table Orientation	(0011,xx26)	SL	1
ROI Top Left	(0011,xx27)	SL	2
ROI Bottom Right	(0011,xx28)	SL	2
Energy Correct Name	(0011,xx33)	LO	1
Spatial Correct Name	(0011,xx34)	LO	1
Tuning Calib Name	(0011,xx35)	LO	1
Uniformity Correct Name	(0011,xx36)	LO	1
Acquisition Specific Correction Name	(0011,xx37)	LT	1
Byte Order	(0011,xx38)	SL	1
Picture Format	(0011,xx3A)	SL	1
Pixel Scale	(0011,xx3B)	FD	1
Pixel Offset	(0011,xx3C)	FD	1
FOV Shape	(0011,xx3E)	SL	1
Dataset Flags	(0011,xx3F)	SL	1
Threshold Center	(0011,xx44)	FD	1
Threshold Width	(0011,xx45)	FD	1
Interpolation Type	(0011,xx46)	SL	1
Period	(0011,xx55)	FD	1
Elapsed Time	(0011,xx56)	FD	1
Private Creator Identification	(0013,0010)	LO	1
Digital FOV	(0013,xx10)	FD	2
AutoTrack Peak	(0013,xx16)	SL	1
AutoTrack Width	(0013,xx17)	SL	1
Transmission Scan Time	(0013,xx18)	FD	1
Transmission Mask Width	(0013,xx19)	FD	1
Copper Attenuator Thickness	(0013,xx1A)	FD	1
Tomo View Offset	(0013,xx1E)	FD	1-n
Study Comments	(0013,xx26)	LT	1

This Page Intentionally Left Blank

4. PATIENT ROOT QUERY/RETRIEVE INFORMATION MODEL DEFINITION

4.1 INTRODUCTION

This section specifies the use of the DICOM Patient Root Query/Retrieve Model used to organize data and against which a Query/Retrieve will be performed. The contents of this section are:

4.2 - Information Model Description

4.3- Information Model Entity-Relationship Model

4.4 - Information Model Keys

4.2 PATIENT ROOT INFORMATION MODEL DESCRIPTION

The Patient Root Query/Retrieve Information Model is based upon a four level hierarchy:

- Patient
- Study
- Series
- Image

The patient level is the top level and contains Attributes associated with the Patient Information Entity (IE) of Image IODs. Patient IEs are modality independent.

The study level is below the patient level and contains Attributes associated with the Study IE of Image IODs. A study belongs to a single patient. A single patient may have multiple studies. Study IEs are modality independent.

The series level is below the study level and contains Attributes associated with the Series, Frame of Reference and Equipment IEs of Image IODs. A series belongs to a single study. A single study may have multiple series. Series IEs are modality dependent

The lowest level is the image level and contains Attributes associated with the Image IE of Image IODs. An image belongs to a single series. A single series may contain multiple images. Image IEs are modality dependent

4.3 PATIENT ROOT INFORMATION MODEL ENTITY-RELATIONSHIP MODEL

The Entity-Relationship diagram for the Patient Root Information Model schema is shown in Figure 4-1. In this figure, the following diagrammatic convention is established to represent the information organization :

- each entity is represented by a rectangular box

- each relationship is represented by a diamond shaped box.
- the fact that a relationship exists between two entities is depicted by lines connecting the corresponding entity boxes to the relationship boxes.

The relationships are fully defined with the maximum number of possible entities in the relationship shown. In other words, the relationship between Series and Image can have up to n Images per Series, but the Patient to Study relationship has 1 Study for each Patient (a Patient can have more than one Study on the system, however each Study will contain all of the information pertaining to that Patient).

FIGURE 4-1
PATIENT ROOT QUERY/RETRIEVE INFORMATION MODEL E/R DIAGRAM

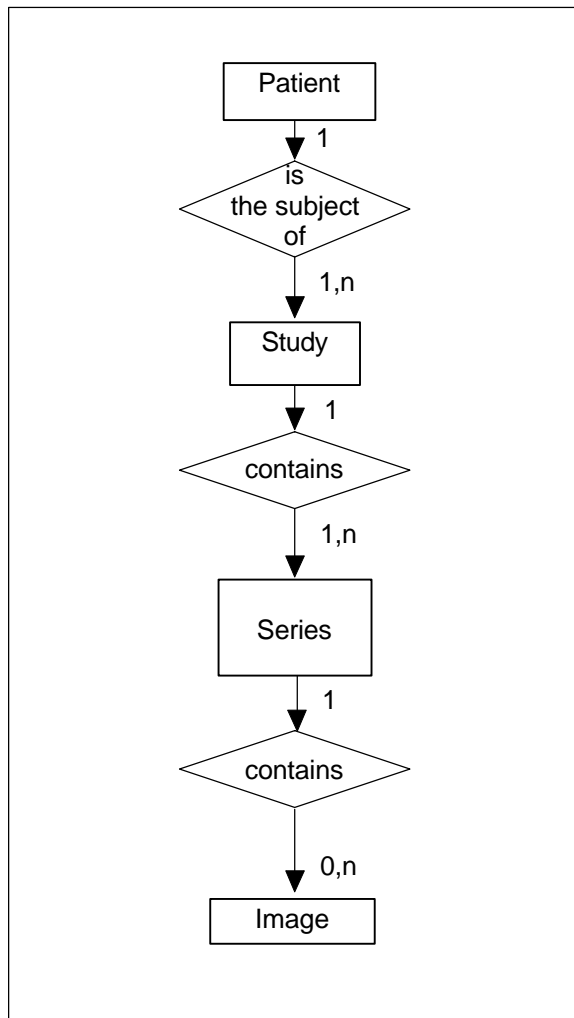

4.3.1 ENTITY DESCRIPTIONS

Please refer to the DICOM v3.0 Standard PS 3.4 (Service Class Specifications) for a description of each of the levels contained within the Patient Root Query/Retrieve Information Model.

4.3.1.1 Patient Entity Description

The Patient Entity defines the characteristics of a patient who is the subject of one or more medical studies which produce medical images.

4.3.1.2 Study Entity Description

The Study Entity defines the characteristics of a medical study performed on a patient. A study is a collection of one or more series of medical images which are logically related for the purpose of diagnosing a patient. Each study is associated with exactly one patient.

4.3.1.3 Series Entity Description

The Series Entity defines the attributes which are used to group images into distinct logical sets. Each series is associated with exactly one study.

4.3.1.4 Image Entity Description

The Image Entity defines the attributes which describe the pixel data of an image. The pixel data is generated as a direct result of patient scanning (an Original image). An image is defined by its image plane, pixel data characteristics gray scale and/or color mapping characteristics and modality specific characteristics (acquisition parameters and image creation information).

4.3.2 GENIE Acquisition Mapping of DICOM Entities

TABLE 4.3-1
MAPPING OF DICOM ENTITIES TO GENIE ACQUISITION ENTITIES

DICOM	GENIE Acquisition Entity
Patient	Patient
Study	Study
Series	Series
Image	Imageset

4.4 INFORMATION MODEL KEYS

Please refer to the DICOM v3.0 Standard PS 3.4 (Service Class Specifications) for a description of each of the levels contained within the Patient Root Query/Retrieve Information Model.

The following Level descriptions are included to specify which data elements are supported and what type of filtering can be applied. It should be noted that they are the same ones as defined in the DICOM v3.0 Standard PS 3.4 (Service Class Specifications).

4.4.1 Supported Filtering

Following are the types of matching that are supported by this implementation :

- Single Value matching
- Wild Card Matching
- Range of date, Range of Time

4.4.2 Patient Level

This section defines the keys at the Patient Level of the Patient Root Query/Retrieve Information Model that are supported by this implementation.

TABLE 4.4-1
PATIENT LEVEL ATTRIBUTES FOR THE PATIENT ROOT QUERY/RETRIEVE INFORMATION MODEL

Attribute Name	Tag	Type	Note
Patient's Name	(0010,0010)	R	Matched. Matching performed without regard to the PN VR individual component values.
Patient ID	(0010,0020)	U	Matched.
Patient Birth Date	(0010,0030)	O	Matched

TABLE 4.4-2
Q/R PATIENT LEVEL AND LOCATION FOR RETRIEVE ATTRIBUTES

Attribute Name	Tag	Type	Note
Query Retrieve Level	(0008,0052)	-	Value = PATIENT
Retrieve AE Title	(0008, 0054)	-	Value = AE Title of SCP.

4.4.3 Study Level

This section defines the keys at the Study Level of the Patient Root Query/Retrieve Information Model that are supported by this implementation.

TABLE 4.4-3
STUDY LEVEL ATTRIBUTES FOR THE PATIENT ROOT QUERY/RETRIEVE INFORMATION MODEL

Attribute Name	Tag	Type	Note
Study Date	(0008,0020)	R	Matched.
Study Time	(0008,0030)	R	Matched.
Accession Number	(0008,0050)	R	NOT Matched in GENIE Acquisition R2.3.1 and R2.3.2. Matched in GENIE Acquisition R2.3.3.
Study ID	(0020,0010)	R	Matched.
Study Instance UID	(0020,000D)	U	Matched.
Study Description	(0008,1030)	O	Matched.

TABLE 4.4-4
Q/R STUDY LEVEL AND LOCATION FOR RETRIEVE ATTRIBUTES

Attribute Name	Tag	Type	Note
Query Retrieve Level	(0008,0052)	-	Value = STUDY
Retrieve AE Title	(0008, 0054)	-	Value = AE Title of SCP.

4.4.4 Series Level

This section defines the keys at the Series Level of the Patient Root Query/Retrieve Information Model that are supported by this implementation.

TABLE 4.4-5
SERIES LEVEL ATTRIBUTES FOR THE PATIENT ROOT QUERY/RETRIEVE INFORMATION MODEL

Attribute Name	Tag	Type	Note
Modality	(0008,0060)	R	Matched.
Series Number	(0020,0011)	R	Matched.
Series Instance UID	(0020,000E)	U	Matched.
Series Date	(0008,0021)	O	Matched.
Series Time	(0008,0031)	O	Matched.
Series Description	(0008,103E)	O	Returned.

TABLE 4.4-6
Q/R SERIES LEVEL AND LOCATION FOR RETRIEVE ATTRIBUTES

Attribute Name	Tag	Type	Note
Query Retrieve Level	(0008,0052)	-	Value = SERIES
Retrieve AE Title	(0008, 0054)	-	Value = AE Title of SCP.

4.4.5 Image Level

This section defines the keys at the Image Level of the Patient Root Query/Retrieve Information Model that are supported by this implementation.

TABLE 4.4-7
IMAGE LEVEL ATTRIBUTES FOR THE PATIENT ROOT QUERY/RETRIEVE INFORMATION MODEL

Attribute Name	Tag	Type	Note
Image Number	(0020,0013)	R	Matched.
SOP Instance UID	(0008,0018)	U	Matched.
Image Type	(0008,0008)	O	Returned.
Image ID	(0054,0400)	O	Returned.
Rows	(0028,0010)	O	Returned.
Columns	(0028,0011)	O	Returned.
Number of Frames	(0028,0008)	O	Returned.

TABLE 4.4-8
Q/R IMAGE LEVEL AND LOCATION FOR RETRIEVE ATTRIBUTES

Attribute Name	Tag	Type	Note
Query Retrieve Level	(0008,0052)	-	Value = IMAGE
Retrieve AE Title	(0008, 0054)	-	Value = AE Title of SCP.

4.5 PRIVATE DATA DICTIONARY

There are no private query key attributes defined for this implementation.

This Page Intentionally Left Blank

5. STUDY ROOT QUERY/RETRIEVE INFORMATION MODEL DEFINITION

5.1 INTRODUCTION

This section specifies the use of the DICOM Study Root Query/Retrieve Model used to organize data and against which a Query/Retrieve will be performed. The contents of this section are:

5.2 - Information Model Description

5.3 - Information Model Entity-Relationship Model

5.4 - Information Model Keys

5.2 STUDY ROOT INFORMATION MODEL DESCRIPTION

The Study Root Query/Retrieve Information Model is based upon a three level hierarchy:

- Study
- Series
- Image

The study level is the top level and contains Attributes associated with the Study IE of Image IODs. Attributes of patients are considered to be attributes of studies. Study IEs are modality independent.

The series level is below the study level and contains Attributes associated with the Series, Frame of Reference and Equipment IEs of Image IODs. A series belongs to a single study. A single study may have multiple series. Series IEs are modality dependent

The lowest level is the image level and contains Attributes associated with the Image IE of Image IODs. An image belongs to a single series. A single series may contain multiple images. Image IEs are modality dependent

5.3 STUDY ROOT INFORMATION MODEL ENTITY-RELATIONSHIP MODEL

The Entity-Relationship diagram for the Study Root Information Model schema is shown in Figure 5-1. In this figure, the following diagrammatic convention is established to represent the information organization:

- each entity is represented by a rectangular box
- each relationship is represented by a diamond shaped box.
- the fact that a relationship exists between two entities is depicted by lines connecting the corresponding entity boxes to the relationship boxes.

The relationships are fully defined with the maximum number of possible entities in the relationship shown. In other words, the relationship between Series and Image can have up to n Images per Series.

FIGURE 5-1
STUDY ROOT QUERY/RETRIEVE INFORMATION MODEL E/R DIAGRAM

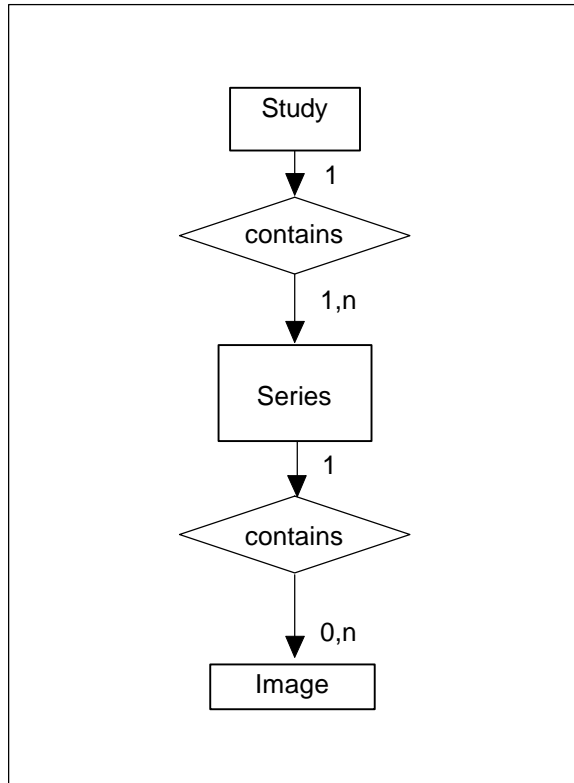

5.3.1 Entity Descriptions

Please refer to the DICOM v3.0 Standard PS 3.4 (Service Class Specifications) for a description of each of the levels contained within the Study Root Query/Retrieve Information Model.

5.3.1.1 Study Entity Description

The Study Entity defines the characteristics of a medical study performed on a patient. A study is a collection of one or more series of medical images which are logically related for the purpose of diagnosing a patient. Each study is associated with exactly one patient.

5.3.1.2 Series Entity Description

The Series Entity defines the attributes which are used to group images into distinct logical sets. Each series is associated with exactly one study.

5.3.1.3 Image Entity Description

The Image Entity defines the attributes which describe the pixel data of an image. The pixel data is generated as a direct result of patient scanning (an Original image). An image is defined by its image plane, pixel data characteristics gray scale and/or color mapping characteristics and modality specific characteristics (acquisition parameters and image creation information).

5.3.2 GENIE ACQUISITION Mapping of DICOM Entities

TABLE 5.3-1
MAPPING OF DICOM ENTITIES TO GENIE ACQUISITION ENTITIES

DICOM	GENIE Acquisition Entity
Study	Study
Series	Series
Image	Imageset

5.4 INFORMATION MODEL KEYS

Please refer to the DICOM v3.0 Standard PS 3.4 (Service Class Specifications) for a description of each of the levels contained within the Study Root Query/Retrieve Information Model.

The following Level descriptions are included to specify what data elements are supported and what type of filtering can be applied. It should be noted that they are the same ones as defined in the DICOM v3.0 Standard PS 3.4 (Service Class Specifications).

5.4.1 Supported Filtering

Following are the types of matching that are supported by this implementation :

- Single Value matching
- Wild Card Matching
- Range of date, Range of Time

5.4.2 Study Level

This section defines the keys at the Study Level of the Study Root Query/Retrieve Information Model that are supported by this implementation.

TABLE 5.4-1
STUDY LEVEL ATTRIBUTES FOR THE STUDY ROOT QUERY/RETRIEVE INFORMATION MODEL

Attribute Name	Tag	Type	Attribute Description
Study Date	(0008,0020)	R	Matched.
Study Time	(0008,0030)	R	Matched.
Accession Number	(0008,0050)	R	NOT matched in GENIE Acquisition R2.3.1 and R2.3.2. Matched in GENIE Acquisition R2.3.3.
Patient's Name	(0010,0010)	R	Matched. Matching performed without regard to the PN VR individual component values.
Patient ID	(0010,0020)	R	Matched.
Study ID	(0020,0010)	R	Matched.
Study Instance UID	(0020,000D)	U	Matched.
Study Description	(0008,1030)	O	Matched.

TABLE 5.4-2
Q/R STUDY LEVEL AND LOCATION FOR RETRIEVE ATTRIBUTES

Attribute Name	Tag	Type	Note
Query Retrieve Level	(0008,0052)	-	Value = STUDY
Retrieve AE Title	(0008, 0054)	-	Value = AE Title of SCP.

5.4.3 Series Level

This section defines the keys at the Series Level of the Study Root Query/Retrieve Information Model that are supported by this implementation.

TABLE 5.4-3
SERIES LEVEL ATTRIBUTES FOR THE STUDY ROOT QUERY/RETRIEVE INFORMATION MODEL

Attribute Name	Tag	Type	Attribute Description
Modality	(0008,0060)	R	Matched.
Series Number	(0020,0011)	R	Matched.
Series Instance UID	(0020,000E)	U	Matched.
Series Date	(0008,0021)	O	Matched.
Series Time	(0008,0031)	O	Matched.
Series Description	(0008,103E)	O	Returned.

TABLE 5.4-4
Q/R SERIES LEVEL AND LOCATION FOR RETRIEVE ATTRIBUTES

Attribute Name	Tag	Type	Note
Query Retrieve Level	(0008,0052)	-	Value = SERIES
Retrieve AE Title	(0008, 0054)	-	Value = AE Title of SCP.

5.4.4 Image Level

This section defines the keys at the Image Level of the Study Root Query/Retrieve Information Model that are supported by this implementation.

**TABLE 5.4-5
 IMAGE LEVEL ATTRIBUTES FOR THE STUDY ROOT QUERY/RETRIEVE INFORMATION MODEL**

Attribute Name	Tag	Type	Attribute Description
Image Number	(0020,0013)	R	Matched.
SOP Instance UID	(0008,0018)	U	Matched.
Image Type	(0008,0008)	O	Returned.
Rows	(0028,0010)	O	Returned.
Columns	(0028,0011)	O	Returned.
Number of Frames	(0028,0008)	O	Returned.

**TABLE 5.4-6
 Q/R IMAGE LEVEL AND LOCATION FOR RETRIEVE ATTRIBUTES**

Attribute Name	Tag	Type	Note
Query Retrieve Level	(0008,0052)	-	Value = IMAGE
Retrieve AE Title	(0008, 0054)	-	Value = AE Title of SCP.

5.5 PRIVATE DATA DICTIONARY

There are no private query key attributes defined for this implementation.

g

GE Medical Systems

*GE Medical Systems: Telex 3797371
P.O. Box 414, Milwaukee, Wisconsin, 53201 U.S.A.
(Asia, Pacific, Latin America, North America)*

*GE Medical Systems – Europe: Telex 698626
283 rue de la Minière, B.P.34, 78533, Buc Cedex, France*