

# **Technical Publications**

**Direction FC250039**  
*Revision 21*

## **Vivid7 version 4 CONFORMANCE STATEMENT for DICOM**

**(From version 4.2.2)**

Copyright© 2008 By General Electric Co.

**Do not duplicate**



---

***GE Ultrasound***

**THIS PAGE LEFT INTENTIONALLY BLANK**

## TABLE OF CONTENTS

<b>1. INTRODUCTION .....</b>	<b>1</b>
<b>1.1 OVERVIEW.....</b>	<b>1</b>
<b>1.2 OVERALL DICOM CONFORMANCE STATEMENT DOCUMENT STRUCTURE.....</b>	<b>2</b>
<b>1.3 INTENDED AUDIENCE .....</b>	<b>3</b>
<b>1.4 SCOPE AND FIELD OF APPLICATION .....</b>	<b>3</b>
<b>1.5 IMPORTANT REMARKS .....</b>	<b>4</b>
<b>1.6 REFERENCES.....</b>	<b>4</b>
<b>1.7 DEFINITIONS .....</b>	<b>5</b>
<b>1.8 SYMBOLS AND ABBREVIATIONS .....</b>	<b>5</b>
<b>2. NETWORK CONFORMANCE STATEMENT .....</b>	<b>6</b>
<b>2.1 INTRODUCTION.....</b>	<b>6</b>
<b>2.2 IMPLEMENTATION MODEL .....</b>	<b>6</b>
2.2.1 Application Data Flow Diagram .....	6
2.2.2 Functional Definition of AE's.....	8
2.2.3 Sequencing of Real-World Activities.....	8
<b>2.3 AE SPECIFICATIONS .....</b>	<b>9</b>
2.3.1 Vivid7 AE Specification .....	9
<b>2.4 COMMUNICATION PROFILES.....</b>	<b>17</b>
2.4.1 Supported Communication Stacks (PS 3.8, PS 3.9).....	17
2.4.2 TCP/IP Stack.....	17
<b>2.5 EXTENSIONS / SPECIALIZATIONS / PRIVATIZATIONS .....</b>	<b>17</b>
<b>2.6 CONFIGURATION.....</b>	<b>18</b>
2.6.1 AE Title/Presentation Address Mapping.....	18
2.6.2 Configurable Parameters.....	18
<b>2.7 SUPPORT OF EXTENDED CHARACTER SETS .....</b>	<b>19</b>
<b>2.8 CODES AND CONTROLLED TERMINOLOGY .....</b>	<b>19</b>
2.8.1 Fixed Coded Terminology .....	19
<b>2.9 SECURITY PROFILES .....</b>	<b>19</b>

<b>3.</b>	<b>MEDIA STORAGE CONFORMANCE STATEMENT .....</b>	<b>21</b>
3.1	INTRODUCTION.....	21
3.2	IMPLEMENTATION MODEL .....	21
3.2.1	Application Data Flow Diagram .....	21
3.2.2	Functional Definition of AE's.....	21
3.2.3	Sequencing Requirements .....	22
3.2.4	File Meta Information Options (See PS3.10).....	22
3.3	AE SPECIFICATIONS .....	22
3.3.1	Vivid7 AE Specification .....	22
3.4	AUGMENTED AND PRIVATE APPLICATION PROFILES .....	26
3.5	EXTENSIONS, SPECIALIZATIONS, PRIVATIZATIONS OF SOP CLASSES AND TRANSFER SYNTAXES.....	26
3.6	CONFIGURATION.....	27
3.7	SUPPORT OF EXTENDED CHARACTER SETS .....	27
<b>4.</b>	<b>ULTRASOUND (US) INFORMATION OBJECT IMPLEMENTATION.....</b>	<b>28</b>
4.1	INTRODUCTION.....	28
4.2	US IOD IMPLEMENTATION.....	28
4.3	US ENTITY-RELATIONSHIP MODEL .....	28
4.3.1	Entity Descriptions.....	29
4.3.2	Vivid7 Mapping of DICOM Entities .....	29
4.4	IOD MODULE TABLE.....	30
4.5	INFORMATION MODULE DEFINITIONS.....	30
4.5.1	Common Patient Entity Modules .....	31
4.5.2	Common Study Entity Modules .....	31
4.5.3	Common Series Entity Modules.....	33
4.5.4	Common Equipment Entity Modules .....	34
4.5.5	Common Image Entity Modules .....	34
4.5.6	General Modules.....	38
4.5.7	US Modules .....	38
<b>5.</b>	<b>ULTRASOUND MULTIFRAME (US MF) INFORMATION OBJECT IMPLEMENTATION</b>	<b>44</b>
5.1	INTRODUCTION.....	44
5.2	US MF IOD IMPLEMENTATION.....	44
5.3	US MF ENTITY-RELATIONSHIP MODEL .....	44
5.3.1	Entity Descriptions.....	45
5.3.2	Vivid7 Mapping of DICOM entities .....	45

5.4	IOD MODULE TABLE.....	46
5.5	INFORMATION MODULE DEFINITIONS.....	46
5.5.1	Common Image Modules .....	47
<b>6.</b>	<b>SC INFORMATION OBJECT IMPLEMENTATION .....</b>	<b>48</b>
6.1	INTRODUCTION.....	48
6.2	SC IOD IMPLEMENTATION.....	48
6.3	SC ENTITY-RELATIONSHIP MODEL .....	48
6.3.1	Entity Descriptions.....	49
6.3.2	Vivid7 Mapping of DICOM Entities .....	49
6.4	IOD MODULE TABLE.....	50
6.5	INFORMATION MODULE DEFINITIONS.....	50
6.5.1	SC Modules.....	50
<b>7.</b>	<b>SR INFORMATION OBJECT IMPLEMENTATION .....</b>	<b>52</b>
7.1	INTRODUCTION.....	52
7.2	COMPREHENSIVE SR IOD IMPLEMENTATION .....	52
7.3	COMPREHENSIVE SR ENTITY-RELATIONSHIP MODEL .....	52
7.3.1	Entity Descriptions.....	53
7.3.2	Vivid7 Mapping of DICOM Entities .....	53
7.4	IOD MODULE TABLE.....	54
7.5	INFORMATION MODULE DEFINITIONS.....	54
7.5.1	SR Document Series Module .....	55
7.5.2	SR Document General Module .....	55
7.5.3	SR Document Content Module .....	56
7.6	STANDARD EXTENDED AND PRIVATE DATA ATTRIBUTES .....	58
7.7	STANDARD EXTENDED AND PRIVATE CONTEXT GROUPS.....	58
7.8	STANDARD EXTENDED AND PRIVATE TEMPLATES.....	58
7.8.1	Standard Extended Templates.....	58
7.8.2	Private Templates.....	58
<b>8.</b>	<b>BASIC DIRECTORY INFORMATION OBJECT IMPLEMENTATION .....</b>	<b>59</b>
8.1	INTRODUCTION.....	59
8.2	BASIC DIRECTORY IOD IMPLEMENTATION.....	59
8.3	BASIC DIRECTORY ENTITY-RELATIONSHIP MODEL .....	59
8.3.1	Vivid7 Mapping of DICOM entities .....	59

<b>8.4</b>	<b>IOD MODULE TABLE.....</b>	<b>60</b>
<b>8.5</b>	<b>INFORMATION MODULE DEFINITIONS.....</b>	<b>61</b>
8.5.1	Common File Set identification Modules.....	61
8.5.2	Common Directory Information Modules.....	61
8.5.3	Definition of Specific Directory Records.....	63
<b>8.6</b>	<b>PRIVATE DATA DICTIONARY .....</b>	<b>68</b>
<b>9.</b>	<b>MODALITY WORKLIST INFORMATION MODEL DEFINITION.....</b>	<b>69</b>
<b>9.1</b>	<b>INTRODUCTION.....</b>	<b>69</b>
<b>9.2</b>	<b>MODALITY WORKLIST INFORMATION MODEL DESCRIPTION .....</b>	<b>69</b>
<b>9.3</b>	<b>MODALITY WORKLIST INFORMATION MODEL ENTITY-RELATIONSHIP MODEL.....</b>	<b>69</b>
9.3.1	Entity Descriptions.....	70
9.3.2	Vivid7 Mapping of DICOM entities .....	71
<b>9.4</b>	<b>INFORMATION MODEL MODULE TABLE .....</b>	<b>71</b>
<b>9.5</b>	<b>INFORMATION MODEL KEYS.....</b>	<b>72</b>
9.5.1	Supported Matching .....	72
9.5.2	Scheduled Procedure Step Entity .....	73
9.5.3	Requested Procedure Entity .....	74
9.5.4	Imaging Service Request Entity .....	75
9.5.5	Visit Entity .....	75
9.5.6	Patient Entity.....	76
<b>10.</b>	<b>MODALITY PERFORMED PROCEDURE STEP SOP CLASS DEFINITION .....</b>	<b>78</b>
<b>10.1</b>	<b>INTRODUCTION.....</b>	<b>78</b>
<b>10.2</b>	<b>MODALITY PERFORMED PROCEDURE STEP SOP CLASS DEFINITION .....</b>	<b>78</b>
10.2.1	IOD Description.....	78
10.2.2	Operations .....	81
<b>11.</b>	<b>STORAGE COMMITMENT PUSH MODEL SOP CLASS DEFINITION.....</b>	<b>85</b>
<b>11.1</b>	<b>INTRODUCTION.....</b>	<b>85</b>
<b>11.2</b>	<b>STORAGE COMMITMENT PUSH MODEL SOP CLASS DEFINITION .....</b>	<b>85</b>
11.2.1	IOD Description.....	85
11.2.2	DIMSE Service Group .....	85
11.2.3	Operations .....	86
11.2.4	Notifications.....	87
<b>12.</b>	<b>PRINT MANAGEMENT SOP CLASS DEFINITION .....</b>	<b>90</b>
<b>12.1</b>	<b>INTRODUCTION.....</b>	<b>90</b>
<b>12.2</b>	<b>BASIC PRINT MANAGEMENT META SOP CLASSES.....</b>	<b>90</b>

12.2.1	Basic Grayscale Print Management Meta SOP Class.....	90
12.2.2	Basic Color Print Management Meta SOP Class .....	90
<b>12.3</b>	<b>PRINT MANAGEMENT SOP CLASS DEFINITIONS .....</b>	<b>91</b>
12.3.1	Basic Film Session SOP Class .....	91
12.3.2	Basic Film Box SOP Class.....	91
12.3.3	Image Box SOP Class .....	92
12.3.4	Printer SOP Class.....	93
<b>12.4</b>	<b>PRINT MANAGEMENT IODS .....</b>	<b>93</b>
12.4.1	Film Session IOD Module .....	94
12.4.2	Basic Film Box IOD Module Table.....	94
12.4.3	Basic Image Box IOD Module Table.....	94
12.4.4	Printer IOD Module Table .....	94
<b>12.5</b>	<b>INFORMATION MODULE DEFINITIONS.....</b>	<b>94</b>
12.5.1	General Modules.....	95
12.5.2	Print Management Modules .....	95
<b>13.</b>	<b>STUDY ROOT QUERY/RETRIEVE INFORMATION MODEL DEFINITION .....</b>	<b>101</b>
13.1	INTRODUCTION.....	101
13.2	STUDY ROOT INFORMATION MODEL DESCRIPTION .....	101
13.3	STUDY ROOT INFORMATION MODEL ENTITY-RELATIONSHIP MODEL.....	101
13.3.1	Entity Descriptions.....	102
13.3.2	Vivid7 Mapping of DICOM entities .....	102
13.4	INFORMATION MODEL KEYS.....	102
13.4.1	Supported Matching .....	103
13.4.2	Study Level .....	103
13.4.3	Series Level.....	104
13.4.4	Image Level.....	105
13.5	PRIVATE DATA DICTIONARY .....	106
<b>14.</b>	<b>SR MAPPING TABLE .....</b>	<b>107</b>

# 1. INTRODUCTION

## 1.1 OVERVIEW

This DICOM Conformance Statement is divided into Sections as described below:

**Section 1 (Introduction)**, which describes the overall structure, intent, and references for this Conformance Statement

**Section 2 (Network Conformance Statement)**, which specifies the GEHC equipment compliance to the DICOM requirements for the implementation of Networking features.

**Section 3 (Media Storage Conformance Statement)**, which specifies the GEHC equipment compliance to the DICOM requirements for the implementation of Media Storage features.

**Section 4 (Ultrasound Information Object Implementation)**, which specifies the GEHC equipment compliance to DICOM requirements for the implementation of an Ultrasound Medicine Information Object.

**Section 5 (Ultrasound Multi-Frame Information Object Implementation)**, which specifies the GEHC equipment compliance to DICOM requirements for the implementation of an Ultrasound Multi-Frame Information.

**Section 6 (SC Object Implementation)**, which specifies the GEHC equipment compliance to DICOM requirements for the implementation of a Secondary Capture Information Object.

**Section 7 (SR Object Implementation)**, which specifies the GEHC equipment compliance to DICOM requirements for the implementation of a Comprehensive Structured Reporting Information Object.

**Section 8 (Basic Directory Information Object Implementation)**, which specifies the GEHC equipment compliance to DICOM requirements for the implementation of a Basic Directory Information Object.

**Section 9 (Modality Worklist Information Model)**, which specifies the GEHC equipment compliance to DICOM requirements for the implementation of the Modality Worklist service.

**Section 10 (Modality Performed Procedure Step SOP Class Definition)**, which specifies the GEHC equipment compliance to DICOM requirements for the implementation of Modality Performed Procedure Step Service.

**Section 11 (Storage Commitment Push Model SOP Class Definition)**, which specifies the GEHC equipment compliance to DICOM requirements for the implementation of the Storage Commitment Push Model Service.

**Section 12 (Basic Print Meta SOP Class Information Object Implementation)**, which specifies the GEHC equipment compliance to DICOM requirements for the implementation of Basic Print Meta SOP Classes (Gray and Color).

**Section 13 (Study Root Query/Retrieve Information Model)**, which specifies the GEHC equipment compliance to DICOM requirements for the Study Root Query/Retrieve Information Model.

**Section 14 (SR Mapping)**, which specifies how measurements are mapped to DICOM SR.



**1.2 OVERALL DICOM CONFORMANCE STATEMENT DOCUMENT STRUCTURE**

The Documentation Structure of the GEHC Conformance Statements and their relationship with the DICOM Conformance Statements is shown in the Illustration below.

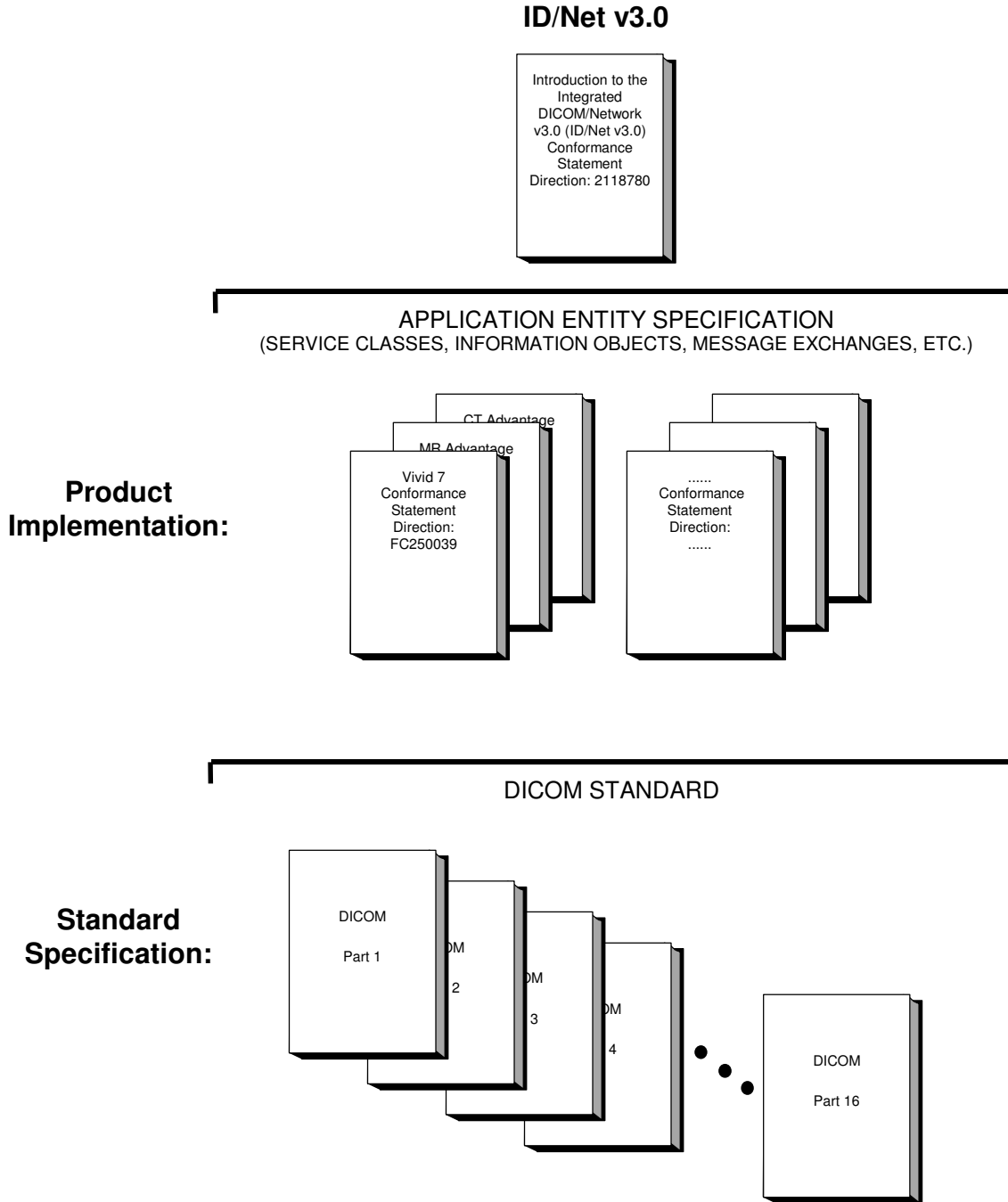

This document specifies the DICOM implementation. It is entitled:

*Vivid7 version 4  
Conformance Statement for DICOM  
Direction FC250039*

This DICOM Conformance Statement documents the DICOM Conformance Statement and Technical Specification required to inter-operate with the GEHC network interface. Introductory information, which is applicable to all GEHC Conformance Statements, is described in the document:

*Introduction to the Integrated DICOM/Network v3.0 (ID/Net v3.0)  
Conformance Statement  
Direction: 2118780.*

This Introduction familiarizes the reader with DICOM terminology and general concepts. It should be read prior to reading the individual products' GEHC Conformance Statements.

The GEHC Conformance Statement, contained in this document, also specifies the Lower Layer communications, which it supports (e.g. TCP/IP). However, the Technical Specifications are defined in the DICOM Part 8 standard.

For more information including Network Architecture and basic DICOM concepts, please refer to the Introduction.

For more information regarding DICOM, copies of the Standard may be obtained by written request or phone by contacting:

DICOM Secretariat  
NEMA  
1300 N. 17th Street, Suite 1847  
Rosslyn, VA 22209 USA

### 1.3 INTENDED AUDIENCE

The reader of this document is concerned with software design and/or system integration issues. It is assumed that the reader of this document is familiar with the DICOM Standards and with the terminology and concepts, which are used in those Standards.

If readers are unfamiliar with DICOM terminology they should first refer to the document listed below, then read the DICOM Standard itself, prior to reading this DICOM Conformance Statement document.

*Introduction to the Integrated DICOM/Network v3.0 (ID/Net v3.0)  
Conformance Statement  
Direction: 2118780*

### 1.4 SCOPE AND FIELD OF APPLICATION

It is the intent of this document, in conjunction with the *Introduction to the Integrated DICOM/Network v3.0 (ID/Net v3.0) Conformance Statement, Direction: 2118780*, to provide an unambiguous specification for GEHC implementations. This specification, called a Conformance Statement, includes a DICOM Conformance Statement and is necessary to ensure proper processing and interpretation of GEHC medical data exchanged using DICOM. The GEHC Conformance Statements are available to the public.

The reader of this DICOM Conformance Statement should be aware that different GEHC devices are capable of using different Information Object Definitions. For example, a GEHC CT Scanner may send images using the CT Information Object, MR Information Object, Secondary Capture Object, etc.

Included in this DICOM Conformance Statement are the Module Definitions, which define all data elements, used by this GEHC implementation. If the user encounters unspecified private data elements while parsing a GEHC Data Set, the user is well advised to ignore those data elements (per the DICOM standard). Unspecified private data element information is subject to change without notice. If, however, the device is acting as a “full fidelity storage device”, it should retain and re-transmit all of the private data elements which are sent by GEHC devices.

## 1.5 IMPORTANT REMARKS

The use of these DICOM Conformance Statements, in conjunction with the DICOM Standards, is intended to facilitate communication with GE imaging equipment. However, **by itself, it is not sufficient to ensure that inter-operation will be successful.** The **user (or user's agent)** needs to proceed with caution and address at least four issues:

- **Integration** - The integration of any device into an overall system of interconnected devices goes beyond the scope of standards (DICOM), and of this introduction and associated DICOM Conformance Statements when interoperability with non-GE equipment is desired. The responsibility to analyze the applications requirements and to design a solution that integrates GE imaging equipment with non-GE systems is the **user's** responsibility and should not be underestimated. The **user** is strongly advised to ensure that such an integration analysis is correctly performed.
- **Validation** - Testing the complete range of possible interactions between any GE device and non-GE devices, before the connection is declared operational, should not be overlooked. Therefore, the **user** should ensure that any non-GE provider accepts full responsibility for all validation required for their connection with GE devices. This includes the accuracy of the image data once it has crossed the interface between the GE imaging equipment and the non-GE device and the stability of the image data for the intended applications.
- Such a validation is required before any clinical use (diagnosis and/or treatment) is performed. It applies when images acquired on GE imaging equipment are processed/displayed on a non-GE device, as well as when images acquired on non-GE equipment is processed/displayed on a GE console or workstation.
- **Future Evolution** - GE understands that the DICOM Standard will evolve to meet the user's growing requirements. GE is actively involved in the development of the DICOM Standard. DICOM will incorporate new features and technologies and GE may follow the evolution of the Standard. The GEHC protocol is based on DICOM as specified in each DICOM Conformance Statement. Evolution of the Standard may require changes to devices, which have implemented DICOM. **In addition, GE reserves the right to discontinue or make changes to the support of communications features (on its products) reflected on by these DICOM Conformance Statements.** The **user** should ensure that any non-GE provider, which connects with GE devices, also plans for the future evolution of the DICOM Standard. Failure to do so will likely result in the loss of function and/or connectivity as the DICOM Standard changes and GE Products are enhanced to support these changes.
- **Interaction** - It is the sole responsibility of the **non-GE provider** to ensure that communication with the interfaced equipment does not cause degradation of GE imaging equipment performance and/or function.

## 1.6 REFERENCES

A list of references, which is applicable to all GEHC Conformance Statements, is included in the *Introduction to the Integrated DICOM/Network v3.0 (ID/Net v3.0) Conformance Statement, Direction: 2118780.*

The information object implementation refers to DICOM PS 3.3 (Information Object Definition).

**1.7 DEFINITIONS**

A set of definitions, which is applicable to all GEHC Conformance Statements, is included in *the Introduction to the Integrated DICOM/Network v3.0 (ID/Net v3.0) Conformance Statement, Direction: 2118780.*

**1.8 SYMBOLS AND ABBREVIATIONS**

A list of symbols and abbreviations, which is applicable to all GEHC Conformance Statements, is included in *the Introduction to the Integrated DICOM/Network v3.0 (ID/Net v3.0) Conformance Statement, Direction: 2118780.*

## **2. NETWORK CONFORMANCE STATEMENT**

### **2.1 INTRODUCTION**

This section of the DICOM Conformance Statement specifies the compliance to DICOM conformance requirements for the relevant **Networking** features for Vivid7 version 4. Note that the format of this section strictly follows the format defined in DICOM Standard PS 3.2 (Conformance). Please refer to that part of the standard while reading this section.

Vivid7 is an Ultrasound scanner running on a commercial computer. It allows for the following DICOM functionality:

- Sending and receiving Echo messages to and from DICOM Verification SCP and client.
- Exporting DICOM images and results to a DICOM SCP or saving the DICOM images and results to DICOM media format.
- Browsing and viewing DICOM images on DICOM media format.
- Querying and retrieving DICOM Modality Worklist from a Worklist SCP.
- Sending start and end of examination to a DICOM Modality Performed Procedure Step SCP.
- Sending storage commitment requests (and receiving replies) to a DICOM Storage Commitment SCP.
- Printing images to a DICOM Printer.
- Querying for examinations from a DICOM Query/Retrieve SCP.

### **2.2 IMPLEMENTATION MODEL**

#### **2.2.1 Application Data Flow Diagram**

The Basic and Specific Application models for this device are shown in the following illustration:

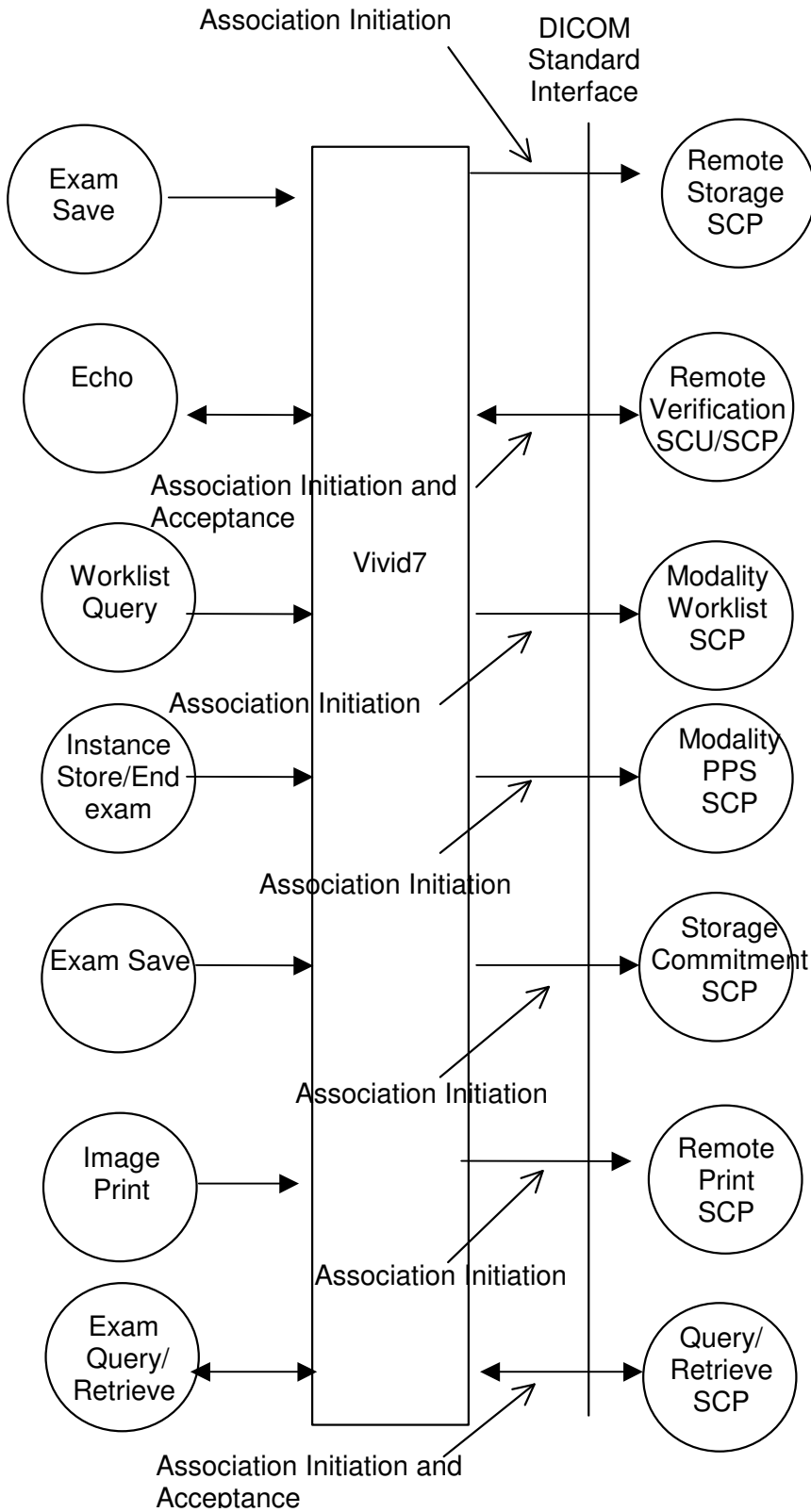

There are six local real-world activities that occur in Vivid7 - **Exam Save, Echo, Worklist Query, Image Store/End Exam, Image Print** and **Exam Query/Retrieve**

**Exam save** initiates a connection with the DICOM SCP and transmits images and results to the DICOM SCP. If Storage Commitment is configured a commitment request will be sent for the images and results.

**Echo** initiates a connection with the DICOM SCP, posts a Verification request and closes the connection. It also responds to incoming Verification requests (for service use).

**Worklist Query** initiates a connection with the DICOM SCP, performs a query and retrieves the matching entries to the product.

**Image Store/End exam:** If Modality Performed Procedure Step is configured N-CREATE and N-SET messages will be sent for the exam.

**Image Print** will send images to a DICOM Print SCP.

**Exam Query/Retrieve** initiates a connection with the DICOM SCP, performs a query and retrieves selected examination.

### 2.2.2 Functional Definition of AE's

Application Entity Vivid7 supports the following functions:

- Initiates a DICOM association to send images and results.
- Transmits DICOM images and results to the DICOM Storage SCP.
- Initiates a DICOM verification to assist in network diagnostics.
- Responds to DICOM verification requests from other devices.
- Initiates a DICOM worklist query to receive worklist information.
- Initiates a DICOM association to notify start of examination.
- Initiates a DICOM association to notify end of examination.
- Initiates a DICOM association to request storage commitment of images.
- Responds to replies for storage commitment requests of images.
- Initiates a DICOM association to print images.
- Initiates a DICOM association to query for and retrieve examinations.
- Responds to replies for examination retrieve requests.

### 2.2.3 Sequencing of Real-World Activities

Not applicable.

**2.3 AE SPECIFICATIONS****2.3.1 Vivid7 AE Specification**

This Application Entity provides Standard Conformance to the following DICOM SOP Classes as an SCU:

<b>SOP Class Name</b>	<b>SOP Class UID</b>
Ultrasound Multi-frame Image Storage	1.2.840.10008.5.1.4.1.1.3.1
Ultrasound Multi-frame Image Storage (Retired)	1.2.840.10008.5.1.4.1.1.3
Ultrasound Image Storage	1.2.840.10008.5.1.4.1.1.6.1
Ultrasound Image Storage (Retired)	1.2.840.10008.5.1.4.1.1.6
Secondary Capture Image Storage	1.2.840.10008.5.1.4.1.1.7
Verification SOP Class	1.2.840.10008.1.1
Modality Worklist Information Model - FIND	1.2.840.10008.5.1.4.31
Modality Performed Procedure Step SOP Class	1.2.840.10008.3.1.2.3.3
Storage Commitment Push Model SOP Class	1.2.840.10008.1.20.1
Basic Grayscale Print Management Meta SOP Class	1.2.840.10008.5.1.1.9
Basic Color Print Management Meta SOP Class	1.2.840.10008.5.1.1.18
Study Root Query/Retrieve Information Model – FIND	1.2.840.10008.5.1.4.1.2.2.1
Study Root Query/Retrieve Information Model – MOVE	1.2.840.10008.5.1.4.1.2.2.2
Comprehensive Structured Report Storage	1.2.840.10008.5.1.4.1.1.88.33

This Application Entity provides Standard Conformance to the following DICOM SOP Classes as an SCP:

<b>SOP Class Name</b>	<b>SOP Class UID</b>
Ultrasound Multi-frame Image Storage	1.2.840.10008.5.1.4.1.1.3.1
Ultrasound Multi-frame Image Storage (Retired)	1.2.840.10008.5.1.4.1.1.3
Ultrasound Image Storage	1.2.840.10008.5.1.4.1.1.6.1
Ultrasound Image Storage (Retired)	1.2.840.10008.5.1.4.1.1.6
Secondary Capture Image Storage	1.2.840.10008.5.1.4.1.1.7
Verification SOP Class	1.2.840.10008.1.1



**2.3.1.1 Association Establishment Policies**

**2.3.1.1.1 General**

The DICOM Application Context Name (ACN), which is always proposed, is:

<b>Application Context Name</b>	<b>1.2.840.10008.3.1.1.1</b>
---------------------------------	------------------------------

The Maximum Length PDU negotiation is included in all association establishment requests. The maximum length PDU for an association initiated by Vivid7 is:

<b>Maximum Length PDU</b>	<b>32768</b>
---------------------------	--------------

The SOP Class Extended Negotiation is not supported.

The user information Items sent by this product are:

- Maximum PDU Length
- Implementation UID
- Implementation Version Name

**2.3.1.1.2 Number of Associations**

The Vivid7 AE will initiate multiple DICOM associations.

**2.3.1.1.3 Asynchronous Nature**

Asynchronous mode is not supported. All operations will be performed synchronously.

**2.3.1.1.4 Implementation Identifying Information**

The Implementation UID for this DICOM Implementation is:

<b>Vivid7 Implementation UID</b>	<b>1.2.840.113619.6.98</b>
----------------------------------	----------------------------

The Implementation Version Name for this DICOM Implementation is:

<b>Vivid7 Implementation Version Name</b>	<b>VIVID7_4</b>
---	-----------------

Note: The Implementation Version Name may change in the future without modification of this document.

**2.3.1.2 Association Initiation Policy**

The Vivid7 AE attempts to establish a new association with a remote device due to six Real-World Activities:

- Exam save initiated by the operator for images and results and sending request for Storage Commitment.
- Verification, which verifies application level communication between peer DICOM AE's for service purposes.
- Worklist initiated by the operator for receiving worklist information.
- Image Store/End Exam sending messages to Modality Performed Procedure Step.
- Print initiated by the operator for a specific image or group of images.
- Exam Query/Retrieve initiated by the operator for receiving examination information and selecting examination to retrieve.

**2.3.1.2.1 Real-World Activity A ('Exam save' Operation)****2.3.1.2.1.1 Associated Real-World Activity**

Upon a request by the operator (manual or automatic), images will be sent to a DICOM Storage SCP.

**2.3.1.2.1.2 Proposed Presentation Context Tables**

The Proposed Presentation Context Table depends on compression according to the following table:

<b>Presentation Context Table – Proposed</b>					
<b>Abstract Syntax</b>		<b>Transfer Syntax</b>		<b>Role</b>	<b>Extended Negotiation</b>
<b>Name</b>	<b>UID</b>	<b>Name List</b>	<b>UID List</b>		
<b>Presentation Context Table: Compression set to None</b>					
Secondary Capture Image Storage	1.2.840.10008.5.1.4.1.1.7	Explicit VR Little Endian Explicit VR Big Endian Implicit VR Little Endian	1.2.840.10008.1.2.1 1.2.840.10008.1.2.2 1.2.840.10008.1.2	SCU	None
Ultrasound Image Storage	1.2.840.10008.5.1.4.1.1.6.1	Explicit VR Little Endian Explicit VR Big Endian Implicit VR Little Endian	1.2.840.10008.1.2.1 1.2.840.10008.1.2.2 1.2.840.10008.1.2	SCU	None
Ultrasound Multi-frame Image Storage	1.2.840.10008.5.1.4.1.1.3.1	Explicit VR Little Endian Explicit VR Big Endian Implicit VR Little Endian	1.2.840.10008.1.2.1 1.2.840.10008.1.2.2 1.2.840.10008.1.2	SCU	None
Ultrasound Image Storage (retired)	1.2.840.10008.5.1.4.1.1.6	Explicit VR Little Endian Explicit VR Big Endian Implicit VR Little Endian	1.2.840.10008.1.2.1 1.2.840.10008.1.2.2 1.2.840.10008.1.2	SCU	None
Ultrasound Multi-frame Image Storage (retired)	1.2.840.10008.5.1.4.1.1.3	Explicit VR Little Endian Explicit VR Big Endian Implicit VR Little Endian	1.2.840.10008.1.2.1 1.2.840.10008.1.2.2 1.2.840.10008.1.2	SCU	None
<b>Presentation Context Table: Compression set to RLE</b>					
Secondary Capture Image Storage	1.2.840.10008.5.1.4.1.1.7	Run Length Encoding, RLE Explicit VR Little Endian Explicit VR Big Endian Implicit VR Little Endian	1.2.840.10008.1.2.5 1.2.840.10008.1.2.1 1.2.840.10008.1.2.2 1.2.840.10008.1.2	SCU	None
Ultrasound Image Storage	1.2.840.10008.5.1.4.1.1.6.1	Run Length Encoding, RLE	1.2.840.10008.1.2.5	SCU	None

		Explicit VR Little Endian Explicit VR Big Endian Implicit VR Little Endian	1.2.840.10008.1.2.1 1.2.840.10008.1.2.2 1.2.840.10008.1.2		
Ultrasound Multi-frame Image Storage	1.2.840.10008.5.1.4.1.1.3.1	Run Length Encoding, RLE Explicit VR Little Endian Explicit VR Big Endian Implicit VR Little Endian	1.2.840.10008.1.2.5  1.2.840.10008.1.2.1 1.2.840.10008.1.2.2 1.2.840.10008.1.2	SCU	None
Ultrasound Image Storage (retired)	1.2.840.10008.5.1.4.1.1.6	Run Length Encoding, RLE Explicit VR Little Endian Explicit VR Big Endian Implicit VR Little Endian	1.2.840.10008.1.2.5  1.2.840.10008.1.2.1 1.2.840.10008.1.2.2 1.2.840.10008.1.2	SCU	None
Ultrasound Multi-frame Image Storage (retired)	1.2.840.10008.5.1.4.1.1.3	Run Length Encoding, RLE Explicit VR Little Endian Explicit VR Big Endian Implicit VR Little Endian	1.2.840.10008.1.2.5  1.2.840.10008.1.2.1 1.2.840.10008.1.2.2 1.2.840.10008.1.2	SCU	None
<b>Presentation Context Table: Compression set to JPEG</b>					
Secondary Capture Image Storage	1.2.840.10008.5.1.4.1.1.7	JPEG Baseline	1.2.840.10008.1.2.4.5 0	SCU	None
Ultrasound Image Storage	1.2.840.10008.5.1.4.1.1.6.1	JPEG Baseline	1.2.840.10008.1.2.4.5 0	SCU	None
Ultrasound Multi-frame Image Storage	1.2.840.10008.5.1.4.1.1.3.1	JPEG Baseline	1.2.840.10008.1.2.4.5 0	SCU	None
Ultrasound Image Storage	1.2.840.10008.5.1.4.1.1.6	JPEG Baseline	1.2.840.10008.1.2.4.5 0	SCU	None
Ultrasound Multi-frame Image Storage (retired)	1.2.840.10008.5.1.4.1.1.3	JPEG Baseline	1.2.840.10008.1.2.4.5 0	SCU	None
<b>Presentation Context Table for Structured Reports</b>					
Comprehensive Structured Report	1.2.840.10008.5.1.4.1.1.88.33	Explicit VR Little Endian Explicit VR Big Endian Implicit VR Little Endian	1.2.840.10008.1.2.1 1.2.840.10008.1.2.2 1.2.840.10008.1.2	SCU	None

**2.3.1.2.1.2.1 SOP Specific DICOM Conformance Statement for all Storage SOP Classes**

This operation also sends a Storage Commitment Request, with the following proposed presentation context. The result from the SCP is expected on another association for the Storage Commitment result.

<b>Presentation Context Table Proposed</b>					
<b>Abstract Syntax</b>		<b>Transfer Syntax</b>		<b>Role</b>	<b>Extended Negotiation</b>
<b>Name</b>	<b>UID</b>	<b>Name List</b>	<b>UID List</b>		
Storage Commitment Push Model SOP Class	1.2.840.10008.1.20.1	Explicit VR Little Endian Explicit VR Big Endian Implicit VR Little Endian	1.2.840.10008.1.2.1 1.2.840.10008.1.2.2 1.2.840.10008.1.2	SCU	None

For these SOP classes (Storage and Storage Commitment), all status codes with status Refused or Error are treated as failures and terminate the association and operation. On a failure, the request will be put in a holding queue for the user to manually retry the request. All status codes with status Warning or Success are treated as successes.

**2.3.1.2.2 Real-World Activity B ('Echo' Operation)****2.3.1.2.2.1 Associated Real-World Activity**

The user may initiate a DICOM Verification Request in the Config screen.

Associations will be released upon the receipt of each C-ECHO confirmation.

In the event that the SCP does not respond, the operation will time out, close the association and inform the user.

**2.3.1.2.2.2 Proposed Presentation Context Table**

Presentation Context Table - Proposed					
Abstract Syntax		Transfer Syntax		Role	Extended Negotiation
Name	UID	Name List	UID List		
Verification SOP Class	1.2.840.10008.1.1	Explicit VR Little Endian Explicit VR Big Endian Implicit VR Little Endian	1.2.840.10008.1.2.1 1.2.840.10008.1.2.2 1.2.840.10008.1.2	SCU	None

**2.3.1.2.3 Real-World Activity C ('Worklist Query' Operation)****2.3.1.2.3.1 Associated Real-World Activity**

The user may initiate a DICOM Worklist Query in Search screen, which will send a C-FIND-RQ to the Worklist SCP.

Associations will be released upon the receipt of C-FIND-RSP confirmation.

**2.3.1.2.3.2 Proposed Presentation Context Tables**

Presentation Context Table – Proposed					
Abstract Syntax		Transfer Syntax		Role	Extended Negotiation
Name	UID	Name List	UID List		
Modality Worklist Information Model - FIND	1.2.840.10008.5.1.4.31	Explicit VR Little Endian Explicit VR Big Endian Implicit VR Little Endian	1.2.840.10008.1.2.1 1.2.840.10008.1.2.2 1.2.840.10008.1.2	SCU	None

**2.3.1.2.3.2.1 SOP Specific DICOM Conformance Statement for Worklist SOP Classes**

All status codes with status Refused or Error are treated as failures and terminate the association and operation. On a failure, the user will be informed and the last successful query will be used as Worklist. All status codes with status Warning or Success are treated as successes.

**2.3.1.2.4 Real-World Activity D ('Image Store/End exam' Operation)****2.3.1.2.4.1 Associated Real-World Activity**

The Modality Performed Procedure Step messages are sent when the first image is acquired for an exam and when the exam is ended (for the case where there are no images, the N-CREATE is sent when the exam is ended). For an exam with saved

images or results, the N-SET will be sent with status COMPLETED. For an exam without saved images or results, the N-SET will be sent with status DISCONTINUED.

**2.3.1.2.4.2 Proposed Presentation Context Table**

Presentation Context Table – Proposed					
Abstract Syntax		Transfer Syntax		Role	Extended Negotiation
Name	UID	Name List	UID List		
Modality Performed Procedure Step SOP Class	1.2.840.10008.3.1.2.3.3	Explicit VR Little Endian	1.2.840.10008.1.2.1	SCU	None
		Explicit VR Big Endian	1.2.840.10008.1.2.2		
		Implicit VR Little Endian	1.2.840.10008.1.2		

**2.3.1.2.4.2.1 SOP Specific DICOM Conformance Statement for Modality Performed Procedure Step Class**

For this SOP class, all status codes with status Refused or Error are treated as failures and terminate the association and operation. All status codes with status Warning or Success are treated as successes.

The Vivid7 AE includes attributes in the Modality Performed Procedure Step N-CREATE and N-SET as described in Section 10.2. The mapping from Worklist attributes is described in Section 9.5.

**2.3.1.2.5 Real-World Activity E (‘Image Print’ Operation)**

**2.3.1.2.5.1 Associated Real-World Activity**

Upon a request by the operator, print jobs will be sent to a DICOM Print SCP. If an error occurs during the transmission, the current association is released and a new association initiated. The maximum number of retries is configurable.

**2.3.1.2.5.2 Proposed Presentation Context Tables**

The following table is used:

Presentation Context Table - Proposed					
Abstract Syntax		Transfer Syntax		Role	Extended Negotiation
Name	UID	Name List	UID List		
Basic Grayscale Print Management Meta SOP Class	1.2.840.10008.5.1.1.9	Explicit VR Little Endian	1.2.840.10008.1.2.1	SCU	None
		Explicit VR Big Endian	1.2.840.10008.1.2.2		
		Implicit VR Little Endian	1.2.840.10008.1.2		
Basic Color Print Management Meta SOP Class	1.2.840.10008.5.1.1.18	Explicit VR Little Endian	1.2.840.10008.1.2.1	SCU	None
		Explicit VR Big Endian	1.2.840.10008.1.2.2		
		Implicit VR Little Endian	1.2.840.10008.1.2		

**2.3.1.2.5.2.1 SOP Specific DICOM Conformance Statement for all Print Management SOP Classes**

All status codes with status Refused or Error are treated as failures and terminate the association and operation. All status codes with status Warning or Success are treated as successes.

**2.3.1.2.6 Real-World Activity F ('Exam Query/Retrieve' Operation)****2.3.1.2.6.1 Associated Real-World Activity**

The user may initiate a DICOM Exam Query in Search screen, which will send a C-FIND-RQ to the Query/Retrieve SCP.

Associations will be released upon the receipt of C-FIND-RSP confirmation.

The user may then select an examination to be retrieved, using the C-MOVE-RQ command to the Query/Retrieve SCP. The result from the SCP is expected on another association for the retrieved examinations.

**2.3.1.2.6.2 Proposed Presentation Context Tables**

Presentation Context Table – Proposed					
Abstract Syntax		Transfer Syntax		Role	Extended Negotiation
Name	UID	Name List	UID List		
Study Root Query/Retrieve Information Model - FIND	1.2.840.10008.5.1.4.1.2.2.1	Explicit VR Little Endian	1.2.840.10008.1.2.1	SCU	None
		Explicit VR Big Endian	1.2.840.10008.1.2.2		
		Implicit VR Little Endian	1.2.840.10008.1.2		
Study Root Query/Retrieve Information Model - MOVE	1.2.840.10008.5.1.4.1.2.2.2	Explicit VR Little Endian	1.2.840.10008.1.2.1	SCU	None
		Explicit VR Big Endian	1.2.840.10008.1.2.2		
		Implicit VR Little Endian	1.2.840.10008.1.2		

**2.3.1.2.6.2.1 SOP Specific DICOM Conformance Statement for Study Root Query/Retrieve Information Model - FIND SOP Classes**

All status codes with status Refused or Error are treated as failures and terminate the association and operation. All status codes with status Warning or Success are treated as successes.

Vivid7 will only support hierarchical query.

**2.3.1.2.6.2.2 SOP Specific DICOM Conformance Statement for Study Root Query/Retrieve Information Model - MOVE SOP Classes**

All status codes with status Refused or Error are treated as failures and terminate the association and operation. All status codes with status Warning or Success are treated as successes.

**2.3.1.3 Association Acceptance Policy**

The AE accepts an association when Vivid7 receives a Verification Request from another network device or a C-STORE request as part of a Query/Retrieve operation.

**2.3.1.3.1 Real-World Activity B – ('Echo' operation)****2.3.1.3.1.1 Associated Real-World Activity**

An incoming Verification Request will cause the AE to accept the association and respond with a Verification Response.

**2.3.1.3.1.2 Accepted Presentation Context Table**

Presentation Context Table - Accepted
---------------------------------------

Abstract Syntax		Transfer Syntax		Role	Extended Negotiation
Name	UID	Name List	UID List		
Verification SOP Class	1.2.840.10008.1.1	Explicit VR Little Endian Explicit VR Big Endian Implicit VR Little Endian	1.2.840.10008.1.2.1 1.2.840.10008.1.2.2 1.2.840.10008.1.2	SCP	None

#### 2.3.1.3.1.2.1 SOP Specific DICOM Conformance Statement for Verify SOP Class

The AE provides standard conformance to the Verification SOP Class as an SCP. The default port number is 104.

#### 2.3.1.3.1.3 Presentation Context Acceptance Criterion

No criterion.

#### 2.3.1.3.1.4 Transfer Syntax Selection Policies

The selected transfer syntax is based on the proposed transfer syntax list. The priority order is Explicit VR Little Endian, Explicit VR Big Endian and Implicit VR Little Endian.

#### 2.3.1.3.2 Real-World Activity F ('Exam Query/Retrieve' Operation)

##### 2.3.1.3.2.1 Associated Real-World Activity

If the user has initiated a retrieve by a C-MOVE-RQ, the AE will accept associations for C-STORE-RQs. The images will be stored locally.

##### 2.3.1.3.2.2 Accepted Presentation Context Table

Presentation Context Table - Accepted					
Abstract Syntax		Transfer Syntax		Role	Extended Negotiation
Name	UID	Name List	UID List		
Ultrasound Image Storage	1.2.840.10008.5.1.4.1.1.6.1	JPEG Baseline Explicit VR Little Endian Explicit VR Big Endian Implicit VR Little Endian Run Length Encoding, RLE	1.2.840.10008.1.2.4.50 1.2.840.10008.1.2.1 1.2.840.10008.1.2.2 1.2.840.10008.1.2 1.2.840.10008.1.2.5	SCP	None
Ultrasound Multi-frame Image Storage	1.2.840.10008.5.1.4.1.1.3.1	JPEG Baseline Explicit VR Little Endian Explicit VR Big Endian Implicit VR Little Endian Run Length Encoding, RLE	1.2.840.10008.1.2.4.50 1.2.840.10008.1.2.1 1.2.840.10008.1.2.2 1.2.840.10008.1.2 1.2.840.10008.1.2.5	SCP	None

Ultrasound Image Storage (retired)	1.2.840.10008.5.1.4.1.1.6	JPEG Baseline Explicit VR Little Endian Explicit VR Big Endian Implicit VR Little Endian Run Length Encoding, RLE	1.2.840.10008.1.2.4.50 1.2.840.10008.1.2.1 1.2.840.10008.1.2.2 1.2.840.10008.1.2 1.2.840.10008.1.2.5	SCP	None
Ultrasound Multi-frame Image Storage (retired)	1.2.840.10008.5.1.4.1.1.3	JPEG Baseline Explicit VR Little Endian Explicit VR Big Endian Implicit VR Little Endian Run Length Encoding, RLE	1.2.840.10008.1.2.4.50 1.2.840.10008.1.2.1 1.2.840.10008.1.2.2 1.2.840.10008.1.2 1.2.840.10008.1.2.5	SCP	None
Secondary Capture Image Storage	1.2.840.10008.5.1.4.1.1.7	JPEG Baseline Explicit VR Little Endian Explicit VR Big Endian Implicit VR Little Endian Run Length Encoding, RLE	1.2.840.10008.1.2.4.50 1.2.840.10008.1.2.1 1.2.840.10008.1.2.2 1.2.840.10008.1.2 1.2.840.10008.1.2.5	SCP	None

#### 2.3.1.3.2.2.1 SOP Specific DICOM Conformance Statement for Storage SOP Classes

The AE provides standard conformance to the Storage SOP Classes as an SCP. The default port number is 104.

#### 2.3.1.3.2.3 Presentation Context Acceptance Criterion

No criterion.

#### 2.3.1.3.2.4 Transfer Syntax Selection Policies

The selected transfer syntax is based on the proposed transfer syntax list. The priority order is JPEG Baseline Explicit VR Little Endian Explicit VR Big Endian Implicit VR Little Endian and Run Length Encoding, RLE.

### 2.4 COMMUNICATION PROFILES

#### 2.4.1 Supported Communication Stacks (PS 3.8, PS 3.9)

DICOM Upper Layer (PS 3.8) is supported using TCP/IP.

#### 2.4.2 TCP/IP Stack

The TCP/IP stack is inherited from the product's operating system. Please refer to product documentation for more information.

#### 2.4.2.1 API

Not applicable to this product.

### 2.5 EXTENSIONS / SPECIALIZATIONS / PRIVATIZATIONS

If so configured, the product will send ultrasound raw data information in private data elements designated by the Private Creator element:



Element Name	Tag	VR	VM	Description
Private Creator	7FE1,00xx	LO	1	GEMS_Ultrasound_MovieGroup_001

This means that all private tags starting with 7FE1,xx will belong to the GEMS\_Ultrasound\_MovieGroup\_001.

If so configured, the product will send preview image in private data elements designated by the Private Creator element:

Element Name	Tag	VR	VM	Description
Private Creator	6003,00xx	LO	1	GEMS_Ultrasound_ImageGroup_001

This means that all private tags starting with 6003,xx will belong to the GEMS\_Ultrasound\_ImageGroup\_001.

If so configured, the product will send exam information in private data elements designated by the Private Creator element:

Element Name	Tag	VR	VM	Description
Private Creator	6005,00xx	LO	1	GEMS_Ultrasound_ExamGroup_001

This means that all private tags starting with 6005,xx will belong to the GEMS\_Ultrasound\_ExamGroup\_001.

## 2.6 CONFIGURATION

### 2.6.1 AE Title/Presentation Address Mapping

The Local AE title is configurable through the Config screen, see below.

### 2.6.2 Configurable Parameters

#### Network:

- Local IP address
- Local port number (default 104)
- Local IP netmask
- Local routing table information

#### Local:

- Local AE Title

#### Verification:

- The AE Title, IP address and port number of the SCP
- Max retries, Retry interval, Timeout

#### Modality Worklist:

- The AE Title, IP address and port number of the SCP
- Max retries, Retry interval, Timeout
- Disabling/enabling and setting constant values for query fields
- Maximum number of downloaded entries

**Storage:**

- The AE Title, IP address and port number of the SCP
- Max retries, Retry interval, Timeout
- Enable/disable raw data
- Frame rate reduction
- Enable/disable multi-frame
- Compression selections
- Color support
- Association strategies: one association per image or one association per exam
- Enable/disable results.

**Modality Performed Procedure Step:**

- The AE Title, IP address and port number of the SCP
- Max retries, Retry interval, Timeout

**Storage Commitment:**

- The AE Title, IP address and port number of the SCP
- Max retries, Retry interval, Timeout

**Print:**

- The AE Title, IP address and port number of the SCP
- Max retries, Retry interval, Timeout
- Configuration for each job according to attribute description in Section 11 of this document.

**Query/Retrieve:**

- The AE Title, IP address and port number of the SCP
- Max retries, Retry interval, Timeout
- Disabling/enabling and setting constant values for query fields
- Maximum number of downloaded entries

**2.7 SUPPORT OF EXTENDED CHARACTER SETS**

Vivid7 will support the ISO\_IR 100 (ISO 8859-1:1987 Latin alphabet N 1. supplementary set) as extended character set. Any incoming SOP instance that is encoded using another extended character set will not be displayed.

**2.8 CODES AND CONTROLLED TERMINOLOGY****2.8.1 Fixed Coded Terminology**

The product uses the fixed (non-configurable, non-extensible) coded terminology in SR Document attributes, as described in Section 7 SR INFORMATION OBJECT IMPLEMENTATION.

**2.9 SECURITY PROFILES**

The product does not conform to any defined DICOM Security Profiles.

It is assumed that the product is used within a secured environment. It is assumed that a secured environment includes at a minimum:

1. Firewall or router protections to ensure that only approved external hosts have network access to the product.

2. Firewall or router protections to ensure that the product only has network access to approved external hosts and services.
3. Any communications with external hosts and services outside the locally secured environment use appropriate secure network channels (such as a Virtual Private Network(VPN))

### 3. MEDIA STORAGE CONFORMANCE STATEMENT

#### 3.1 INTRODUCTION

This section of the conformance statement (CS) specifies the Vivid7 compliance to DICOM Media Interchange. It details the DICOM Media Storage Application Profiles and roles, which are supported by this product.

Vivid7 is able to export images and results to DICOM media, browse DICOM media or read images from DICOM media.

#### 3.2 IMPLEMENTATION MODEL

##### 3.2.1 Application Data Flow Diagram

The Basic and Specific Application models for this device are shown in the following Illustration:

ILLUSTRATION 3-1  
SPECIFIC AE APPLICATION MODEL

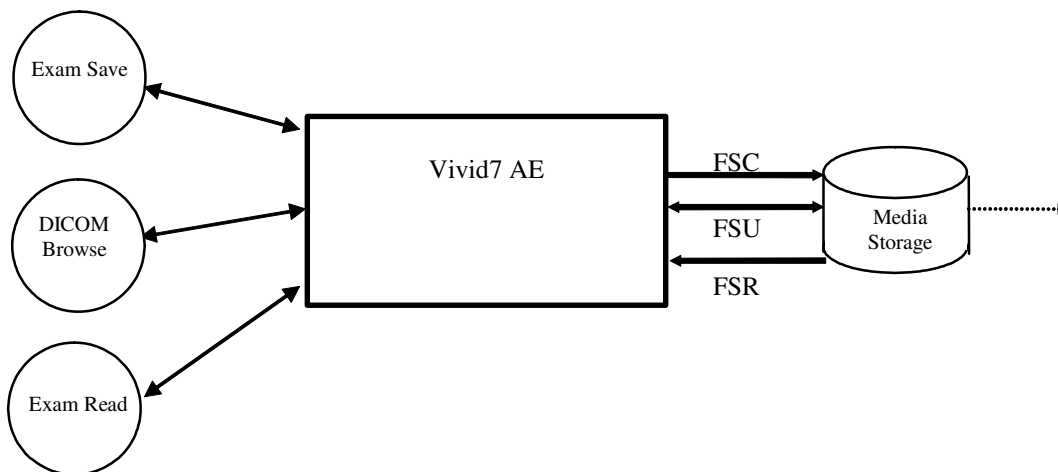

Vivid7 can initialize Media by acting as an FSC to create a new DICOM File-set on either 320 MB MOD, 640 MB MOD, 1.2 GB MOD, 2.4 GB MOD or Floppy. The SOP instances written to media must be one of the instances supported by Vivid7. A pre-existing File-set will be updated with the information in DICOM files copied to media.

##### 3.2.2 Functional Definition of AE's

Vivid7 can perform these functions:

- Create a new DICOM File-set on media

- Update DICOM File-set by adding new SOP instances to the File-set
- Read information and images from the existing File-set

### 3.2.3 Sequencing Requirements

None applicable

### 3.2.4 File Meta Information Options (See PS3.10)

The File Meta-Information for this implementation is:

<b>File Meta-Information Version</b>	<b>1</b>
<b>Vivid7 Implementation UID</b>	<b>1.2.840.113619.6.98</b>
<b>Implementation Version Name</b>	<b>VIVID7_4</b>

Note: The Implementation Version Name may change in the future without modification of this document.

## 3.3 AE SPECIFICATIONS

### 3.3.1 Vivid7 AE Specification

The Vivid7 Application Entity provides standard conformance to DICOM Interchange Option of the Media Storage Service Class. The Application Profiles and roles are listed below, the standard profiles are augmented with Secondary Capture images. Note that in one case (see 4.5.7.1 US Region Calibration Module), the multi-frame image will be sent without region calibration (i.e. AUG-US-ID-MF-XXX).

<b>Supported Application Profile</b>	<b>Real World Activity</b>	<b>Role</b>	<b>Description</b>
AUG-US-SC-SF-CDR, AUG-US-SC-SF-MOD23-90, AUG-US-SC-MF-CDR, AUG-US-SC-MF-MOD23-90	Exam save	FSR/ FSC/ FSU	Interchange
	Browse	FSR	Interchange
	Exam Read	FSR	Interchange
AUG-US-SC-SF-DVD, AUG-US-SC-MF-DVD	Exam save	FSC	Interchange

#### 3.3.1.1 File Meta Information for the Vivid7 Application Entity

The Source Application Entity is set from the Vivid7 local AE title. The local AE is configurable.

Following are the default value set in the File Meta Information for this AE Title:

<b>Source Application Entity Title</b>	<b>VIVID7_4</b>
--	-----------------

### 3.3.1.2 Real-World Activities for the Vivid7 Application Entity

#### 3.3.1.2.1 Real-World Activity “Exam save”

“Exam save” saves a DICOM SOP instance to media and updates DICOM File Set.

##### 3.3.1.2.1.1 Media Storage Application Profile for the Real-World Activity “Exam save”:

For the list of Application Profiles that invoke this AE for “Exam save” Real-World Activity, see the Table in Section 3.3.1 “Vivid7 AE Specification” where the table describing the profiles and real-world activities is defined.

##### 3.3.1.2.1.1.1 Options

Following are the SOP Classes supported by the Real-World Activity “Exam save”:

Information Object Definition	SOP Class UID	Transfer Syntax	Transfer Syntax UID
DICOM Media Storage Directory	1.2.840.10008.1.3.10	Explicit VR Little Endian	1.2.840.10008.1.2.1
Ultrasound Multi-frame Image Storage	1.2.840.10008.5.1.4.1.1.3.1	Explicit VR Little Endian	1.2.840.10008.1.2.1
		Run Length Encoding, RLE	1.2.840.10008.1.2.5
		JPEG Baseline	1.2.840.10008.1.2.4.50
Ultrasound Image Storage	1.2.840.10008.5.1.4.1.1.6.1	Explicit VR Little Endian	1.2.840.10008.1.2.1
		Run Length Encoding, RLE	1.2.840.10008.1.2.5
		JPEG Baseline	1.2.840.10008.1.2.4.50
Secondary Capture Image Storage	1.2.840.10008.5.1.4.1.1.7	Explicit VR Little Endian	1.2.840.10008.1.2.1
		Run Length Encoding, RLE	1.2.840.10008.1.2.5
		JPEG Baseline	1.2.840.10008.1.2.4.50
Comprehensive Structured Report	1.2.840.10008.5.1.4.1.1.88.33	Explicit VR Little Endian	1.2.840.10008.1.2.1

#### 3.3.1.2.2 Real-World Activity “DICOM Browse”

DICOM Browse is activated when the user searches for an exam in Search screen.

##### 3.3.1.2.3 Media Storage Application Profile for the Real-World Activity “DICOM Browse”

For the list of Application Profiles that invoke this AE for Image Read Real-World Activity, see the Table in Section 3.2.1 “Vivid7 AE Specification”.

## 3.3.1.2.3.1.1 Options

Following are the SOP Classes supported by the Real-World Activity DICOM Browse:

Information Object Definition	SOP Class UID	Transfer Syntax	Transfer Syntax UID
DICOM Media Storage Directory	1.2.840.10008.1.3.10	Explicit VR Little Endian	1.2.840.10008.1.2.1
Ultrasound Multi-frame Image Storage	1.2.840.10008.5.1.4.1.1.3.1	Explicit VR Little Endian	1.2.840.10008.1.2.1
		Implicit VR Little Endian	1.2.840.10008.1.2
		Run Length Encoding, RLE	1.2.840.10008.1.2.5
		JPEG Baseline	1.2.840.10008.1.2.4.50
Ultrasound Multi-frame Image Storage(retired)	1.2.840.10008.5.1.4.1.1.3	Explicit VR Little Endian	1.2.840.10008.1.2.1
		Implicit VR Little Endian	1.2.840.10008.1.2
		Run Length Encoding, RLE	1.2.840.10008.1.2.5
		JPEG Baseline	1.2.840.10008.1.2.4.50
Ultrasound Image Storage	1.2.840.10008.5.1.4.1.1.6.1	Explicit VR Little Endian	1.2.840.10008.1.2.1
		Implicit VR Little Endian	1.2.840.10008.1.2
		Run Length Encoding, RLE	1.2.840.10008.1.2.5
		JPEG Baseline	1.2.840.10008.1.2.4.50
Ultrasound Image Storage (retired)	1.2.840.10008.5.1.4.1.1.6	Explicit VR Little Endian	1.2.840.10008.1.2.1
		Implicit VR Little Endian	1.2.840.10008.1.2
		Run Length Encoding, RLE	1.2.840.10008.1.2.5
		JPEG Baseline	1.2.840.10008.1.2.4.50
Secondary Capture Image Storage	1.2.840.10008.5.1.4.1.1.7	Explicit VR Little Endian	1.2.840.10008.1.2.1
		Implicit VR Little Endian	1.2.840.10008.1.2
		Run Length Encoding, RLE	1.2.840.10008.1.2.5

		JPEG Baseline	1.2.840.10008.1.2.4.50
--	--	---------------	------------------------

### 3.3.1.2.4 Real-World Activity “Exam read“

“Exam read” reads and displays a DICOM SOP instance from media.

#### 3.3.1.2.4.1 Media Storage Application Profile for the Real-World Activity “Exam read “

For the list of Application Profiles that invoke this AE for Exam read Real-World Activity, see the Table in Section 3.2.1 “Vivid7 AE Specification”.

##### 3.3.1.2.4.1.1 Options

Following are the SOP Classes supported by the Exam read Real-World Activity:

Information Object Definition	SOP Class UID	Transfer Syntax	Transfer Syntax UID
DICOM Media Storage Directory	1.2.840.10008.1.3.10	Explicit VR Little Endian	1.2.840.10008.1.2.1
Ultrasound Multi-frame Image Storage	1.2.840.10008.5.1.4.1.1.3.1	Explicit VR Little Endian	1.2.840.10008.1.2.1
		Implicit VR Little Endian	1.2.840.10008.1.2
		Run Length Encoding, RLE	1.2.840.10008.1.2.5
		JPEG Baseline	1.2.840.10008.1.2.4.50
Ultrasound Multi-frame Image Storage(retired)	1.2.840.10008.5.1.4.1.1.3	Explicit VR Little Endian	1.2.840.10008.1.2.1
		Implicit VR Little Endian	1.2.840.10008.1.2
		Run Length Encoding, RLE	1.2.840.10008.1.2.5
		JPEG Baseline	1.2.840.10008.1.2.4.50
Ultrasound Image Storage	1.2.840.10008.5.1.4.1.1.6.1	Explicit VR Little Endian	1.2.840.10008.1.2.1
		Implicit VR Little Endian	1.2.840.10008.1.2
		Run Length Encoding, RLE	1.2.840.10008.1.2.5
		JPEG Baseline	1.2.840.10008.1.2.4.50
Ultrasound Image Storage (retired)	1.2.840.10008.5.1.4.1.1.6	Explicit VR Little Endian	1.2.840.10008.1.2.1



		Implicit VR Little Endian	1.2.840.10008.1.2
		Run Length Encoding, RLE	1.2.840.10008.1.2.5
		JPEG Baseline	1.2.840.10008.1.2.4.5 0
Secondary Capture Image Storage	1.2.840.10008.5.1.4.1.1.7	Explicit VR Little Endian	1.2.840.10008.1.2.1
		Implicit VR Little Endian	1.2.840.10008.1.2
		Run Length Encoding, RLE	1.2.840.10008.1.2.5
		JPEG Baseline	1.2.840.10008.1.2.4.5 0

### 3.4 AUGMENTED AND PRIVATE APPLICATION PROFILES

Vivid7 creates Secondary Capture Image Objects in addition to the objects defined in the application profiles.

### 3.5 EXTENSIONS, SPECIALIZATIONS, PRIVATIZATIONS OF SOP CLASSES AND TRANSFER SYNTAXES

If so configured, the product will send ultrasound raw data information in private data elements designated by the Private Creator element:

Element Name	Tag	VR	VM	Description
Private Creator	7FE1,00xx	LO	1	GEMS_Ultrasound_MovieGroup_001

This means that all private tags starting with 7FE1,xx will belong to the GEMS\_Ultrasound\_MovieGroup\_001.

If so configured, the product will send preview image in private data elements designated by the Private Creator element:

Element Name	Tag	VR	VM	Description
Private Creator	6003,00xx	LO	1	GEMS_Ultrasound_ImageGroup_001

This means that all private tags starting with 6003,xx will belong to the GEMS\_Ultrasound\_ImageGroup\_001.

If so configured, the product will send exam information in private data elements designated by the Private Creator element:

Element Name	Tag	VR	VM	Description
Private Creator	6005,00xx	LO	1	GEMS_Ultrasound_ExamGroup_001

This means that all private tags starting with 6005,xx will belong to the GEMS\_Ultrasound\_ExamGroup\_001.

### **3.6 CONFIGURATION**

The following parameters are configurable:

- Location of DICOMDIR
- Read or Read/Write
- Enable/disable raw data
- Frame rate reduction
- Enable/disable multi-frame
- Compression selections
- Enable/disable results.

### **3.7 SUPPORT OF EXTENDED CHARACTER SETS**

Vivid7 will support only the ISO\_IR 100 (ISO 8859-1:1987 Latin alphabet N 1. supplementary set) as extended character sets. Any incoming SOP instance that is encoded using another extended character set will not be read.

## **4. ULTRASOUND (US) INFORMATION OBJECT IMPLEMENTATION**

### **4.1 INTRODUCTION**

This section specifies the use of the DICOM US Image IOD to represent the information included in US images produced by this implementation. Corresponding attributes are conveyed using the module construct. The contents of this section are:

4.2 - IOD Implementation

4.3 - IOD Entity-Relationship Model

4.4 - IOD Module Table

4.5 - IOD Module Definition

In this section, supported means that tag is sent with value.

### **4.2 US IOD IMPLEMENTATION**

This section defines the implementation of US image information object.

### **4.3 US ENTITY-RELATIONSHIP MODEL**

The Entity-Relationship diagram for the US Image interoperability schema is shown in Illustration 4.3-1. In this figure, the following diagrammatic convention is established to represent the information organization:

- each entity is represented by a rectangular box
- each relationship is represented by a diamond shaped box.
- the fact that a relationship exists between two entities is depicted by lines connecting the corresponding entity boxes to the relationship boxes.

The relationships are fully defined with the maximum number of possible entities in the relationship shown. In other words, the relationship between Series and Image can have up to n Images per Series, but the Patient to Study relationship has 1 Study for each Patient (a Patient can have more than one Study on the system, however each Study will contain all of the information pertaining to that Patient).

ILLUSTRATION 4.3-1  
US IMAGE ENTITY RELATIONSHIP DIAGRAM

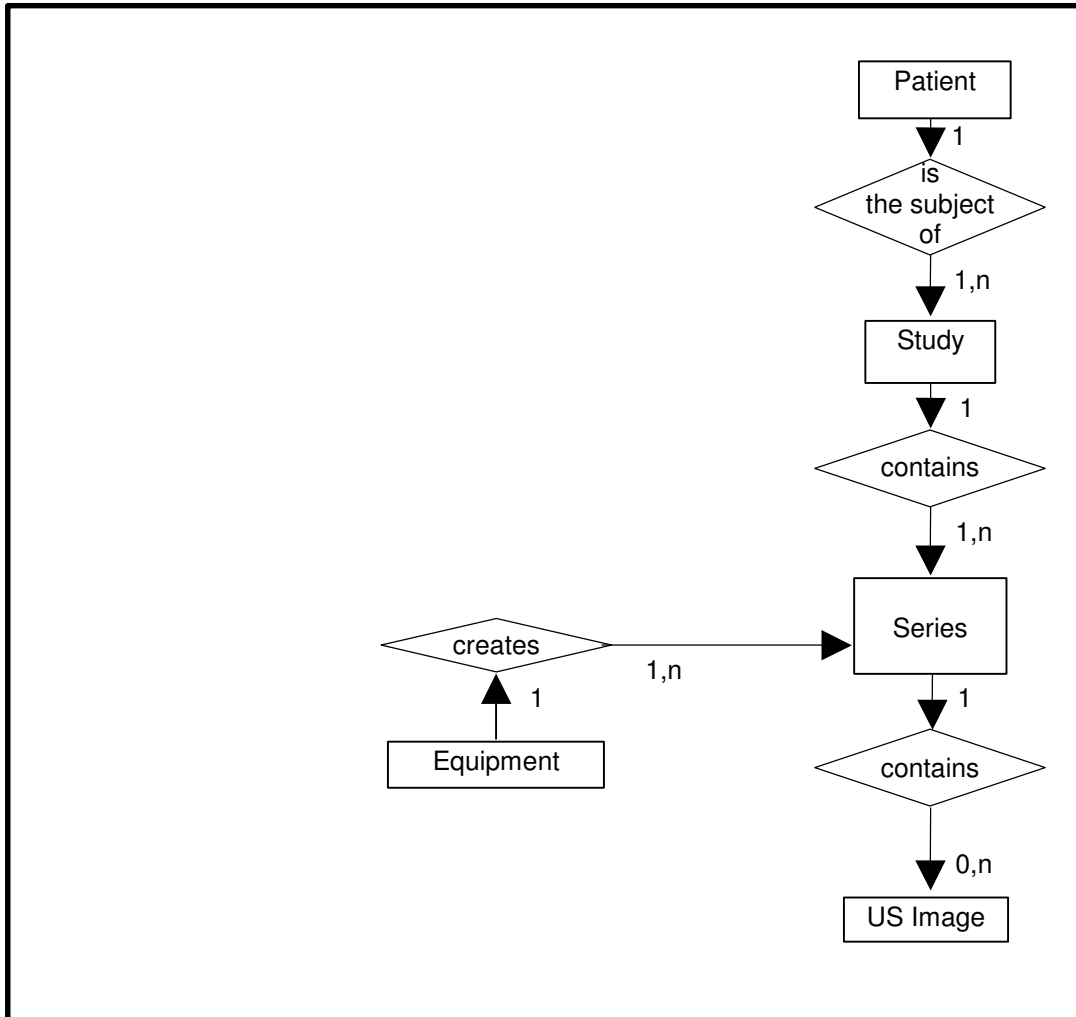

4.3.1 Entity Descriptions

Please refer to DICOM Standard Part 3 (Information Object Definitions) for a description of each of the entities contained within the US Information Object.

4.3.2 Vivid7 Mapping of DICOM Entities

TABLE 4.3-1  
MAPPING OF DICOM ENTITIES TO VIVID7 ENTITIES

DICOM	Vivid7 Entity
Patient	Patient
Study	Exam
Series	Exam
Image	Image
Curve	Not used

#### 4.4 IOD MODULE TABLE

Within an entity of the DICOM US IOD, attributes are grouped into related set of attributes. A set of related attributes is termed a module. A module facilitates the understanding of the semantics concerning the attributes and how the attributes are related with each other. A module grouping does not infer any encoding of information into data sets.

Table 4.4-1 identifies the defined modules within the entities, which comprise the DICOM US IOD. Modules are identified by Module Name.

See DICOM Part 3 for a complete definition of the entities, modules, and attributes.

Only the single frame US Image IOD is described here.

**TABLE 4.4-1  
US IMAGE IOD MODULES**

Entity Name	Module Name	Reference
Patient	Patient	4.5.1.1
Study	General Study	4.5.2.1
	Patient Study	4.5.2.2
Series	General Series	4.5.3.1
Frame of Reference	Frame of Reference	Not used
	US Frame of Reference	Not used
Equipment	General Equipment	4.5.4.1
Image	General Image	4.5.5.1
	Image Pixel	4.5.5.2
	Contrast/Bolus	4.5.5.3
	Palette Color Lookup Table	4.5.5.4
	US Region Calibration	4.5.7.1
	US Image	4.5.7.2
	Overlay Plane	Not used
	VOI LUT	4.5.5.5
SOP Common	4.5.6.1	
Curve	Not used	

#### 4.5 INFORMATION MODULE DEFINITIONS

Please refer to DICOM Standard Part 3 (Information Object Definitions) for a description of each of the entities and modules contained within the US Information Object.

The following modules are included to convey Enumerated Values, Defined Terms, and Optional Attributes supported. Type 1 & Type 2 Attributes are also included for completeness and to define what values they may take and where these values are obtained. It should be noted that they are the same ones as defined in the DICOM Standard Part 3 (Information Object Definitions).

#### 4.5.1 Common Patient Entity Modules

##### 4.5.1.1 Patient Module

This section specifies the Attributes of the Patient that describe and identify the Patient who is the subject of a diagnostic Study. This Module contains Attributes of the patient that are needed for diagnostic interpretation of the Image and are common for all studies performed on the patient.

**TABLE 4.5-1  
PATIENT MODULE ATTRIBUTES**

Attribute Name	Tag	Type	Attribute Description
Patient's Name	(0010,0010)	2	May be entered from User Interface. Taken from worklist if it is there.
Patient ID	(0010,0020)	2	May be entered from User Interface. Taken from worklist if it is there.
Patient's Birth Date	(0010,0030)	2	May be entered from User Interface. Taken from worklist if it is there.
Patient's Sex	(0010,0040)	2	May be entered from User Interface. Taken from worklist if it is there.
Referenced Patient Sequence	(0008,1120)	3	Taken from worklist if it is there. (Not used in SR Documents.)
>Referenced SOP Class UID	(0008,1150)	1C	Taken from worklist if it is there. (Not used in SR Documents.)
>Referenced SOP Instance UID	(0008,1155)	1C	Taken from worklist if it is there. (Not used in SR Documents.)
Patient's Birth Time	(0010,0032)	3	Taken from worklist if it is there.
Other Patient Ids	(0010,1000)	3	Taken from worklist if it is there.
Other Patient Names	(0010,1001)	3	Not used
Ethnic Group	(0010,2160)	3	Taken from worklist if it is there.
Patient Comments	(0010,4000)	3	Taken from worklist if it is there.

#### 4.5.2 Common Study Entity Modules

The following Study IE Modules are common to all Composite Image IODs, which reference the Study IE. These modules contain Attributes of the patient and study that are needed for diagnostic interpretation of the image.

##### 4.5.2.1 General Study Module

This section specifies the attributes that describe and identify the Study performed upon the Patient.

**TABLE 4.5-2  
GENERAL STUDY MODULE ATTRIBUTES**

Attribute Name	Tag	Type	Attribute Description
Study Instance UID	(0020,000D)	1	Uniquely generated by the equipment. Taken from worklist if it is there.
Study Date	(0008,0020)	2	Is set to examination date
Study Time	(0008,0030)	2	Is set to examination time

Referring Physician's Name	(0008,0090)	2	May be entered from User Interface. Taken from worklist if it is there.
Study ID	(0020,0010)	2	May be entered from User Interface. Taken from worklist if it is there (from Requested Procedure Id)
Accession Number	(0008,0050)	2	May be entered from User Interface. Taken from worklist if it is there.
Study Description	(0008,1030)	3	May be entered from User Interface. Taken from worklist if it is there (from Requested Procedure Description).
Physician(s) of Record	(0008,1048)	3	Taken from worklist if it is there (from Names of Intended Recipients of Result)
Name of Physician(s) Reading Study	(0008,1060)	3	Not used
Referenced Study Sequence	(0008,1110)	3	Taken from worklist if it is there. (Not used in SR Documents.)
>Referenced SOP Class UID	(0008,1150)	1C	Taken from worklist if it is there. (Not used in SR Documents.)
>Referenced SOP Instance UID	(0008,1155)	1C	Taken from worklist if it is there. (Not used in SR Documents.)

#### 4.5.2.2 Patient Study Module

This section defines attributes that provide information about the Patient at the time that the Study was performed.

**TABLE 4.5-3  
PATIENT STUDY MODULE ATTRIBUTES**

Attribute Name	Tag	Type	Attribute Description
Admitting Diagnoses Description	(0008,1080)	3	Not used
Patient's Age	(0010,1010)	3	Not used
Patient's Size	(0010,1020)	3	May be entered from User Interface. Taken from worklist if it is there.
Patient's Weight	(0010,1030)	3	May be entered from User Interface. Taken from worklist if it is there.
Occupation	(0010,2180)	3	Not used
Additional Patient's History	(0010,21B0)	3	May be entered from User Interface (in Referral reason). Taken from worklist if it is there.
Admission ID	(0038,0010)	3	Taken from worklist if it is there.
Issuer of Admission ID	(0038,0011)	3	Taken from worklist if it is there.

### 4.5.3 Common Series Entity Modules

The following Series IE Modules are common to all Composite Image IODs, which reference the Series IE.

#### 4.5.3.1 General Series Module

This section specifies the attributes that identify and describe general information about the Series within a Study.

**TABLE 4.5-4  
GENERAL SERIES MODULE ATTRIBUTES**

Attribute Name	Tag	Type	Attribute Description
Modality	(0008,0060)	1	Defined Term "US" used.
Series Instance UID	(0020,000E)	1	Uniquely generated by the equipment
Series Number	(0020,0011)	2	Internal number which is incremented for each new series within a study.
Laterality	(0020,0060)	2C	Not used
Series Date	(0008,0021)	3	Is set to Series date
Series Time	(0008,0031)	3	Is set to Series time
Performing Physicians' Name	(0008,1050)	3	May be entered from User Interface. Taken from worklist if it is there (from Scheduled Performing Physician's Name)
Protocol Name	(0018,1030)	3	Sent if image is acquired in a stress test.
Series Description	(0008,103E)	3	May be entered from User Interface (in Diagnosis).
Operator's Name	(0008,1070)	3	May be entered from User Interface. Default is login id.
Referenced Performed Procedure Step Sequence	(0008,1111)	3	Used if Modality Performed Procedure Step is enabled.
>Referenced SOP Class UID	(0008,1150)	1C	Used if Modality Performed Procedure Step is enabled.
>Referenced SOP Instance UID	(0008,1155)	1C	Used if Modality Performed Procedure Step is enabled.
Body Part Examined	(0018,0015)	3	Not used
Patient Position	(0018,5100)	2C	Not used
Smallest Pixel Value in Series	(0028,0108)	3	Not used
Largest Pixel Value in Series	(0028,0109)	3	Not used
Request Attributes Sequence	(0040,0275)	3	Used if Modality Worklist and/or Modality Performed Procedure Step is enabled.
>Requested Procedure ID	(0040,1001)	1C	Taken from worklist if it is there.
>Scheduled Procedure Step ID	(0040,0009)	1C	Taken from worklist if it is there.
>Scheduled Procedure Step Description	(0040,0007)	3	Taken from worklist if it is there.
>Scheduled Protocol Code Sequence	(0040,0008)	3	Taken from worklist if it is there.
>>Include 'Code Sequence Macro'			
Performed Procedure Step ID	(0040,0253)	3	Used if Modality Performed Procedure Step is enabled.
Performed Procedure Step Start Date	(0040,0244)	3	Used if Modality Performed Procedure Step is enabled.



Performed Procedure Step Start Time	(0040,0245)	3	Used if Modality Performed Procedure Step is enabled.
Performed Procedure Step Description	(0040,0254)	3	Used if Modality Performed Procedure Step is enabled.
Performed Protocol Code Sequence	(0040,0260)	3	Always empty
>Include 'Code Sequence Macro'			

#### 4.5.4 Common Equipment Entity Modules

The following Equipment IE Module is common to all Composite Image IODs, which reference the Equipment IE.

##### 4.5.4.1 General Equipment Module

This section specifies the attributes that identify and describe the piece of equipment, which produced a Series of Images.

**TABLE 4.5-5  
GENERAL EQUIPMENT MODULE ATTRIBUTES**

Attribute Name	Tag	Type	Attribute Description
Manufacturer	(0008,0070)	2	Is set to "GE Vingmed Ultrasound"
Institution Name	(0008,0080)	3	Is set to configured Institution Name.
Institution Address	(0008,0081)	3	Not used
Station Name	(0008,1010)	3	Is set to configured Station Name.
Institutional Department Name	(0008,1040)	3	May be entered from User Interface. Default is configured Department name.
Manufacturer's Model Name	(0008,1090)	3	Is set to "Vivid7".
Device Serial Number	(0018,1000)	3	Not used
Software Versions	(0018,1020)	3	Is set to Vivid7 software version
Spatial Resolution	(0018,1050)	3	Not used
Date of Last Calibration	(0018,1200)	3	Not used
Time of Last Calibration	(0018,1201)	3	Not used
Pixel Padding Value	(0028,0120)	3	Not used

#### 4.5.5 Common Image Entity Modules

The following Image IE Modules are common to all Composite Image IODs, which reference the Image IE.

##### 4.5.5.1 General Image Module

This section specifies the attributes that identify and describe an image within a particular series.

**TABLE 4.5-6  
GENERAL IMAGE MODULE ATTRIBUTES**

Attribute Name	Tag	Type	Attribute Description
Instance Number	(0020,0013)	2	Internal value which is incremented for each image within a series
Patient Orientation	(0020,0020)	2C	Sent with empty value.

Attribute Name	Tag	Type	Attribute Description
Content Date	(0008,0023)	2C	Set from Image date
Content Time	(0008,0033)	2C	Set from Image time
Image Type	(0008,0008)	3	The first two values contain "ORIGINAL\PRIMARY" or "DERIVED\PRIMARY". Value 4 is a description of the mode. Values 5 and 6 may be used for private data.
Acquisition Number	(0020,0012)	3	Not used
Acquisition Date	(0008,0022)	3	Not used
Acquisition Time	(0008,0032)	3	Not used
Acquisition Datetime	(0008,002A)	3	Supported
Referenced Image Sequence	(0008,1140)	3	May be used for related images
>Referenced SOP Class UID	(0008,1150)	1C	
>Referenced SOP Instance UID	(0008,1155)	1C	
>Referenced Frame Number	(0008,1160)	3	Not used
Derivation Description	(0008,2111)	3	May contain additional derivation information if Image Type is DERIVED.
Source Image Sequence	(0008,2112)	3	May be used for source images
>Referenced SOP Class UID	(0008,1150)	1C	
>Referenced SOP Instance UID	(0008,1155)	1C	
>Referenced Frame Number	(0008,1160)	3	Not used
Images in Acquisition	(0020,1002)	3	Not used
Image Comments	(0020,4000)	3	May be used for description of the image
Quality Control Image	(0028,0300)	3	Not used
Burned In Annotation	(0028,0301)	3	Not used
Lossy Image Compression	(0028,2110)	3	Set to 01 if images is lossy compressed.
Lossy Image Compression Ratio	(0028,2112)	3	Used if lossy compressed.

#### 4.5.5.2 Image Pixel Module

This section specified the attributes that describe the pixel data of the image.

**TABLE 4.5-7  
IMAGE PIXEL MODULE ATTRIBUTES**

Attribute Name	Tag	Type	Attribute Description
Samples per Pixel	(0028,0002)	1	Value of '1' if Photometric Interpretation element value has value 'MONOCHROME2' Value of '3' when Photometric Interpretation element value has value 'RGB', 'YBR_FULL' or 'YBR_FULL_422'

Attribute Name	Tag	Type	Attribute Description
Photometric Interpretation	(0028,0004)	1	Defined Values used: "MONOCHROME2", "RGB", "YBR_FULL" or "YBR_FULL_422"
Rows	(0028,0010)	1	Value depends on scanning mode and configuration setup
Columns	(0028,0011)	1	Value depends on scanning mode and configuration setup.
Bits Allocated	(0028,0100)	1	Value always = 0008H.
Bits Stored	(0028,0101)	1	Value always = 0008H.
High Bit	(0028,0102)	1	Value always = 0007H.
Pixel Representation	(0028,0103)	1	Defined Value '0' - unsigned integer.
Pixel Data	(7FE0,0010)	1	Pixel Data of image.
Planar Configuration	(0028,0006)	1C	Enumerated value 0000H, color-by-pixel, if Photometric Interpretation element value has value 'RGB' or if image is JPEG compressed.  Enumerated value 0001H, color-by-plane if image is RLE compressed.
Pixel Aspect Ratio	(0028,0034)	1C	Not used
Smallest Image Pixel Value	(0028,0106)	3	Not used
Largest Image Pixel Value	(0028,0107)	3	Not used
Red Palette Color Lookup Table Descriptor	(0028,1101)	1C	Only used when reading Palette images.
Green Palette Color Lookup Table Descriptor	(0028,1102)	1C	Only used when reading Palette images.
Blue Palette Color Lookup Table Descriptor	(0028,1103)	1C	Only used when reading Palette images.
Red Palette Color Lookup Table Data	(0028,1201)	1C	Only used when reading Palette images.
Green Palette Color Lookup Table Data	(0028,1202)	1C	Only used when reading Palette images.
Blue Palette Color Lookup Table Data	(0028,1203)	1C	Only used when reading Palette images.

#### 4.5.5.3 Contrast/Bolus Module

This section specifies the attributes that describe the contrast /bolus used in the acquisition of the Image.

**TABLE 4.5-8  
CONTRAST/BOLUS MODULE ATTRIBUTES**

Attribute Name	Tag	Type	Attribute Description
Contrast/Bolus Agent	(0018,0010)	2	May be entered from User Interface.
Contrast/Bolus Agent Sequence	(0018,0012)	3	Not used
>Include 'Code Sequence Macro'			
Contrast/Bolus Route	(0018,1040)	3	Not used
Contrast/Bolus Administration Route Sequence	(0018,0014)	3	Not used
>Include 'Code Sequence Macro'			

Attribute Name	Tag	Type	Attribute Description
>Additional Drug Sequence	(0018,002A)	3	Not used
>>Include 'Code Sequence Macro'			
Contrast/Bolus Volume	(0018,1041)	3	Not used
Contrast/Bolus Start Time	(0018,1042)	3	Not used
Contrast/Bolus Stop Time	(0018,1043)	3	Not used
Contrast/Bolus Total Dose	(0018,1044)	3	Not used
Contrast Flow Rate(s)	(0018,1046)	3	Not used
Contrast Flow Duration(s)	(0018,1047)	3	Not used
Contrast/Bolus Ingredient	(0018,1048)	3	Not used
Contrast/Bolus Ingredient Concentration	(0018,1049)	3	Not used

#### 4.5.5.4 Palette Color Lookup Table Module

This section specifies the attributes that describe the Lookup table data for images with Palette Color photometric interpretation.

**TABLE 4.5-9  
PALETTE COLOR LOOKUP MODULE**

Attribute Name	Tag	Type	Attribute Description
Red Palette Color Lookup Table Descriptor	(0028,1101)	1C	Only used when reading Palette images.
Green Palette Color Lookup Table Descriptor	(0028,1102)	1C	Only used when reading Palette images.
Blue Palette Color Lookup Table Descriptor	(0028,1103)	1C	Only used when reading Palette images.
Palette Color Lookup Table UID	(0028,1199)	3	Not used
Red Palette Color Lookup Table Data	(0028,1201)	1C	Only used when reading Palette images.
Green Palette Color Lookup Table Data	(0028,1202)	1C	Only used when reading Palette images.
Blue Palette Color Lookup Table Data	(0028,1203)	1C	Only used when reading Palette images.
Segmented Red Palette Color Lookup Table Data	(0028,1221)	1C	Not used
Segmented Green Palette Color Lookup Table Data	(0028,1222)	1C	Not used
Segmented Red Palette Color Lookup Table Data	(0028,1223)	1C	Not used

#### 4.5.5.5 VOI LUT Module

This section specifies the attributes that identify and describe the VOI LUT Module

**TABLE 4.5-10  
VOI LUT MODULE ATTRIBUTES**

Attribute Name	Tag	Type	Attribute Description
VOI LUT Sequence	(0028,3010)	3	Not used
>LUT Descriptor	(0028,3002)	3	Not used
>LUT Explanation	(0028,3003)	3	Not used
>LUT Data	(0028,3006)	3	Not used
Window Center	(0028,1050)	3	Value set to 127 if Photometric Interpretation has value MONOCHROME2.
Window Width	(0028,1051)	3	Value set to 256 if Photometric Interpretation has value MONOCHROME2.
Window Center & Width Explanation	(0028,1055)	3	Not used

#### 4.5.6 General Modules

The SOP Common Module is mandatory for all DICOM IODs.

##### 4.5.6.1 SOP Common Module

This section defines the attributes that are required for proper functioning and identification of the associated SOP Instances. They do not specify any semantics about the Real-World Object represented by the IOD.

**TABLE 4.5-11  
SOP COMMON MODULE ATTRIBUTES**

Attribute Name	Tag	Type	Attribute Description
SOP Class UID	(0008,0016)	1	Set to "1.2.840.10008.5.1.4.1.1.3.1" "1.2.840.10008.5.1.4.1.1.3" "1.2.840.10008.5.1.4.1.1.6.1" "1.2.840.10008.5.1.4.1.1.6" "1.2.840.10008.5.1.4.1.1.7" or "1.2.840.10008.5.1.4.1.1.88.33"
SOP Instance UID	(0008,0018)	1	Uniquely generated by the equipment
Specific Character Set	(0008,0005)	1C	Set to "ISO_IR 100" if extended characters are used. Image Read: images using other extended character set than "ISO_IR 100" are rejected.
Instance Creation Date	(0008,0012)	3	Not used
Instance Creation Time	(0008,0013)	3	Not used
Instance Creator UID	(0008,0014)	3	Not used
Instance Number	(0020,0013)	3	Not used

#### 4.5.7 US Modules

This Section describes US Series, Equipment, and Image Modules. These Modules contain attributes that are specific to US Image IOD.

## 4.5.7.1 US Region Calibration Module

US Region Calibration Module is used to describe multiple regions. Note: if a multi-frame image has been acquired with different calibration, the US Region Calibration Module will not be used.

**TABLE 4.5-12**  
**US REGION CALIBRATION MODULE ATTRIBUTES**

Attribute Name	Tag	Type	Attribute Description
Sequence of Ultrasound Regions	(0018,6011)	1	Object contains 0 or 1 regions
>Region Location Min $x_0$	(0018,6018)	1	Value is 0
>Region Location Min $y_0$	(0018,601A)	1	Value is 0
>Region Location Max $x_1$	(0018,601C)	1	Value is image width-1.
>Region Location Max $y_1$	(0018,601E)	1	Value is image height-1
>Physical Units X Direction	(0018,6024)	1	Enumerated Values supported: 0003H cm 0004H seconds
>Physical Units Y Direction	(0018,6026)	1	Enumerated Values supported: 0003H cm 0004H seconds 0007H cm/sec
>Physical Delta X	(0018,602C)	1	Varies with scanning mode
>Physical Delta Y	(0018,602E)	1	Varies with scanning mode
>Reference Pixel $x_0$	(0018,6020)	3	Varies with scanning mode
>Reference Pixel $y_0$	(0018,6022)	3	Varies with scanning mode
>Ref. Pixel Physical Value X	(0018,6028)	3	Varies with scanning mode
>Ref. Pixel Physical Value Y	(0018,602A)	3	Varies with scanning mode
>Region Spatial Format	(0018,6012)	1	Supported. The spatial organization of the data within the region.
>Region Data Type	(0018,6014)	1	Supported. The type of data within the region.
>Region Flags	(0018,6016)	1	Bit 0: 0 = Opaque Bit 1: 0 = Not Protected because there may be other regions within the image Bit 2 : 0 = Velocity
>Pixel Component Organization	(0018,6044)	1C	Pixel component calibration data does not exist for any region
>Pixel Component Mask	(0018,6046)	1C	Not used
>Pixel Component Range Start	(0018,6048)	1C	Not used
>Pixel Component Range Stop	(0018,604A)	1C	Not used
>Pixel Component Physical Units	(0018,604C)	1C	Not used
>Pixel Component Data Type	(0018,604E)	1C	Not used
>Number of Table Break Points	(0018,6050)	1C	Not used
>Table of X Break Points	(0018,6052)	1C	Not used
>Table of Y Break Points	(0018,6054)	1C	Not used
>Number of Table Entries	(0018,6056)	1C	Not used
>Table of Pixel Values	(0018,6058)	1C	Not used

Attribute Name	Tag	Type	Attribute Description
>Table of Parameter Values	(0018,605A)	1C	Not used
>Transducer Frequency	(0018,6030)	3	Supported
>Pulse Repetition Frequency	(0018,6032)	3	Supported
>Doppler Correction Angle	(0018,6034)	3	Not used
>Steering Angle	(0018,6036)	3	Not used
>Doppler Sample Volume X Position	(0018,6038)	3	Not used
>Doppler Sample Volume Y Position	(0018,603A)	3	Not used
>TM-Line Position $x_0$	(0018,603C)	3	Not used
>TM-Line Position $y_0$	(0018,603E)	3	Not used
>TM-Line Position $x_1$	(0018,6040)	3	Not used
>TM-Line Position $y_1$	(0018,6042)	3	Not used

## 4.5.7.2 US Image Module

This section specifies the attributes that describe ultrasound images.

**TABLE 4.5-13**  
**US IMAGE MODULE ATTRIBUTES**

Attribute Name	Tag	Type	Attribute Description
Samples Per Pixel	(0028,0002)	1	Value of '1' if Photometric Interpretation element value has value 'MONOCHROME2' Value of '3' when Photometric Interpretation element value has value 'RGB' or 'YBR_FULL' or 'YBR_FULL_422'
Photometric Interpretation	(0028,0004)	1	Defined Values used: "MONOCHROME2", "RGB", "YBR_FULL" or "YBR_FULL_422"
Bits Allocated	(0028,0100)	1	Value always = 0008H
Bits Stored	(0028,0101)	1	Value always = 0008H
High Bit	(0028,0102)	1	Value always = 0007H
Planar Configuration	(0028,0006)	1	Enumerated value 0000H, color-by-pixel, if Photometric Interpretation element value has value 'RGB' or if image is JPEG compressed. Enumerated value 0001H, color-by-plane if image is RLE compressed.
Pixel Representation	(0028,0103)	1	Always 0000H = unsigned integer.
Frame Increment Pointer	(0028,0009)	1C	Export: Is set to Frame Time (0018,1063) or Frame Time Vector (0018,1065) if the image is multiframe IOD, Not used if the image is a single frame IOD.
Image Type	(0008,0008)	2	The first two values contain "ORIGINAL\PRIMARY" or "DERIVED\PRIMARY". Value 4 is a description of the mode. Values 5 and 6 may be used for private data.
Lossy Image Compression	(0028,2110)	1C	Set to 01 if image is compressed using JPEG Baseline compression.
Number of Stages	(0008,2124)	2C	Number of stages in stress protocol. Sent if image is acquired in a stress test.
Number of Views in Stage	(0008,212A)	2C	Number of views in this stage of a stress protocol. Sent if image is acquired in a stress test.
Ultrasound Color Data Present	(0028,0014)	3	Supported
Referenced Overlay Sequence	(0008,1130)	3	Not used
>Referenced SOP Class UID	(0008,1150)	1C	Not used
>Referenced SOP Instance UID	(0008,1155)	1C	Not used
Referenced Curve Sequence	(0008,1145)	3	Not used



Attribute Name	Tag	Type	Attribute Description
>Referenced SOP Class UID	(0008,1150)	1C	Not used
>Referenced SOP Instance UID	(0008,1155)	1C	Not used
Stage Name	(0008,2120)	3	Name of stage of stress test. Sent if image is acquired in a stress test. The name is defined in the User Interface.
Stage Number	(0008,2122)	3	Number of stage, starting at one. Sent if image is acquired in a stress test.
View Name	(0008,2127)	3	Name of view of stress test. Sent if image is acquired in a stress test. The name is defined in the User Interface.
View Number	(0008,2128)	3	Number of view, starting at one. Sent if image is acquired in a stress test.
Number of Event Timers	(0008,2129)	3	Not used
Event Elapsed Time(s)	(0008,2130)	3	Not used
Event Timer Name(s)	(0008,2132)	3	Not used
Anatomic Region Sequence	(0008,2218)	3	Not used
>Include 'Code Sequence Macro'			
>Anatomic Region Modifier Sequence	(0008,2220)	3	Not used
>>Include 'Code Sequence Macro'			
Primary Anatomic Structure Sequence	(0008,2228)	3	Not used
>Include 'Code Sequence Macro'			
>Primary Anatomic Structure Modifier Sequence	(0008,2230)	3	Not used
>>Include 'Code Sequence Macro'			
Transducer Position Sequence	(0008,2240)	3	Not used
>Include 'Code Sequence Macro'			
>Transducer Position Modifier Sequence	(0008,2242)	3	Not used
>>Include 'Code Sequence Macro'			
Transducer Orientation Sequence	(0008,2244)	3	Not used
>Include 'Code Sequence Macro'			
>Transducer Orientation Modifier Sequence	(0008,2246)	3	Not used
>>Include 'Code Sequence Macro'			

Attribute Name	Tag	Type	Attribute Description
Trigger Time	(0018,1060)	3	Not used
Nominal Interval	(0018,1062)	3	Not used
Beat Rejection Flag	(0018,1080)	3	Not used
Low R-R Value	(0018,1081)	3	Not used
High R-R Value	(0018,1082)	3	Not used
Heart Rate	(0018,1088)	3	Set to heart rate
Output Power	(0018,5000)	3	Not used
Transducer Data	(0018,5010)	3	Not used
Transducer Type	(0018,6031)	3	Not used
Focus Depth	(0018,5012)	3	Not used
Preprocessing Function	(0018,5020)	3	Not used
Mechanical Index	(0018,5022)	3	Not used
Bone Thermal Index,	(0018,5024)	3	Not used
Cranial Thermal Index	(0018,5026)	3	Not used
Soft Tissue Thermal Index	(0018,5027)	3	Not used
Soft Tissue-focus Thermal Index	(0018,5028)	3	Not used
Soft Tissue-surface Thermal Index	(0018,5029)	3	Not used
Depth of Scan Field	(0018,5050)	3	Not used
Image Transformation Matrix	(0018,5210)	3	Not used
Image Translation Vector	(0018,5212)	3	Not used
Overlay Subtype	(60xx,0045)	3	Not used

## 5. ULTRASOUND MULTIFRAME (US MF) INFORMATION OBJECT IMPLEMENTATION

### 5.1 INTRODUCTION

This section specifies the use of the DICOM US Multi-frame Image IOD to represent the information included in US images produced by this implementation. Corresponding attributes are conveyed using the module construct. The contents of this section are:

5.2 - IOD Implementation

5.3 - IOD Entity-Relationship Model

5.4 - IOD Module Table

5.5 - IOD Module Definition

### 5.2 US MF IOD IMPLEMENTATION

This section defines the implementation of US Multi-Frame image information object.

### 5.3 US MF ENTITY-RELATIONSHIP MODEL

The Entity-Relationship diagram for the US MF Image interoperability schema is shown in Illustration 5.3-1. In this figure, the following diagrammatic convention is established to represent the information organization:

- each entity is represented by a rectangular box
- each relationship is represented by a diamond shaped box.
- the fact that a relationship exists between two entities is depicted by lines connecting the corresponding entity boxes to the relationship boxes.

The relationships are fully defined with the maximum number of possible entities in the relationship shown. In other words, the relationship between Series and Image can have up to n Images per Series, but the Patient to Study relationship has 1 Study for each Patient (a Patient can have more than one Study on the system, however each Study will contain all of the information pertaining to that Patient).

ILLUSTRATION 5.3-1  
US MULTIFRAME IMAGE ENTITY RELATIONSHIP DIAGRAM

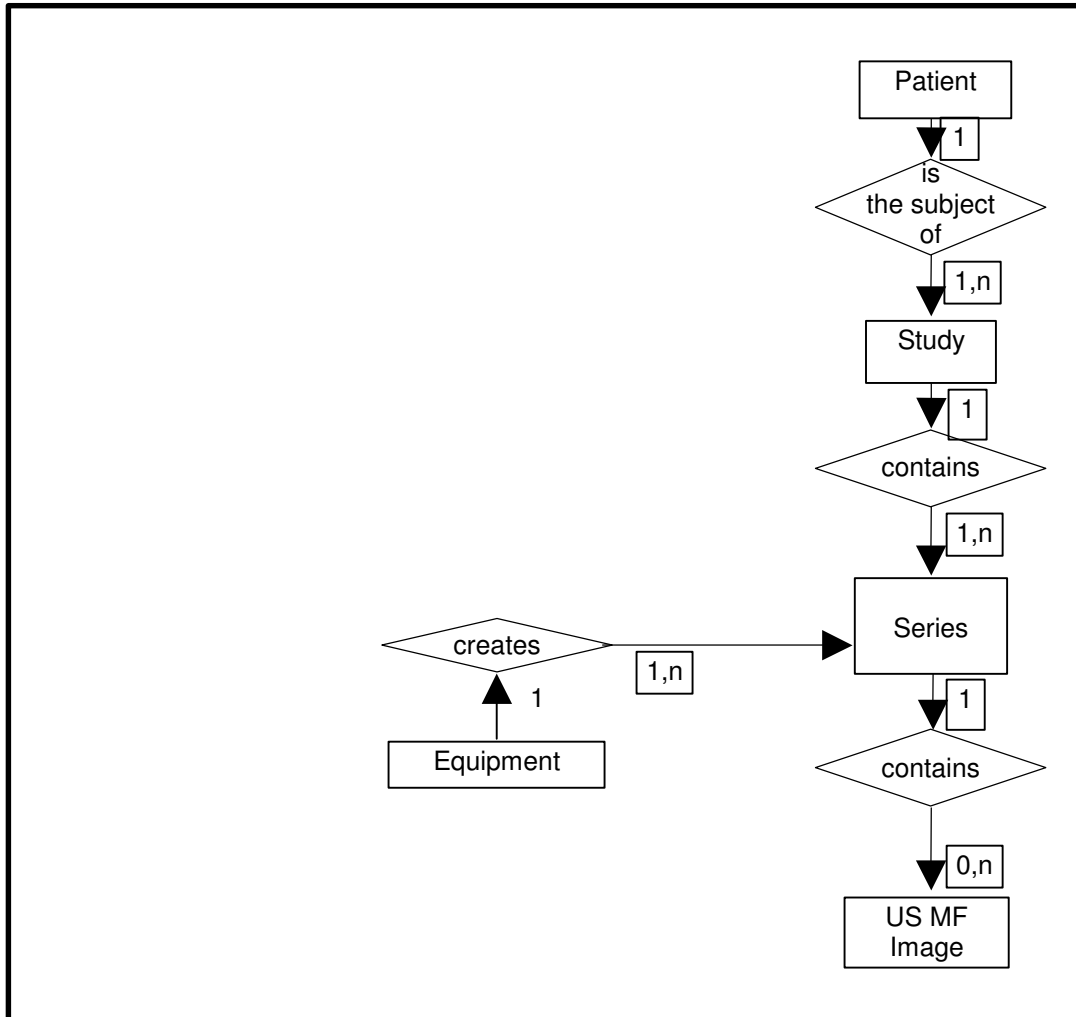

**5.3.1 Entity Descriptions**

Please refer to DICOM Standard Part 3 (Information Object Definitions) for a description of each of the entities contained within the US Multi-Frame Information Object.

**5.3.2 Vivid7 Mapping of DICOM entities**

TABLE 5.3-1  
MAPPING OF DICOM ENTITIES TO VIVID7 ENTITIES

DICOM	Vivid7 Entity
Patient	Patient
Study	Exam
Series	Exam
Image	Image
Curve	Not used

**5.4 IOD MODULE TABLE**

Within an entity of the DICOM US Multi-Frame IOD, attributes are grouped into related set of attributes. A set of related attributes is termed a module. A module facilitates the understanding of the semantics concerning the attributes and how the attributes are related with each other. A module grouping does not infer any encoding of information into datasets.

Table 5.4-1 identifies the defined modules within the entities, which comprise the DICOM US Multi-Frame IOD. Modules are identified by Module Name.

See DICOM Part 3 for a complete definition of the entities, modules, and attributes.

**TABLE 5.4-1**  
**US MULTI-FRAME IOD MODULES**

<b>Entity Name</b>	<b>Module Name</b>	<b>Reference</b>
Patient	Patient	4.5.1.1
Study	General Study	4.5.2.1
	Patient Study	4.5.2.2
Series	General Series	4.5.3.1
	Frame of Reference	Not used
Frame of Reference	US Frame of Reference	Not used
	Equipment	4.5.4.1
Image	General Image	4.5.5.1
	Image Pixel	4.5.5.2
	Contrast/Bolus	4.5.5.3
	Cine	5.5.1.1
	Multi-frame	5.5.1.2
	Palette Color Lookup Table	4.5.5.4
	US Region Calibration	4.5.7.1
	US Image	4.5.7.2
	Overlay Plane	Not used
	VOI LUT	4.5.5.5
Curve	SOP Common	4.5.6.1
	Not used	

**5.5 INFORMATION MODULE DEFINITIONS**

Please refer to DICOM Standard Part 3 (Information Object Definitions) for a description of each of the entities and modules contained within the US Multi-Frame Information Object.

The following modules are included to convey Enumerated Values, Defined Terms, and Optional Attributes supported. Type 1 & Type 2 Attributes are also included for completeness and to define what values they may take and where these values are obtained. It should be noted that they are the same ones as defined in the DICOM Standard Part 3 (Information Object Definitions).

### 5.5.1 Common Image Modules

The following Image IE Modules are common to all Composite Image IODs which reference the Image IE.

#### 5.5.1.1 Cine Module

**TABLE 5.5-2  
CINE MODULE ATTRIBUTES**

Attribute Name	Tag	Type	Attribute Description
Frame Time	(0018,1063)	1C	Is set to the interframe time
Frame Time Vector	(0018,1065)	1C	Supported. Reading: Average value is set to interframe time
Start Trim	(0008,2142)	3	Supported
Stop Trim	(0008,2143)	3	Supported
Recommended Display Frame Rate	(0008,2144)	3	Supported
Cine Rate	(0018,0040)	3	Supported
Frame Delay	(0018,1066)	3	Supported
Effective Duration	(0018,0072)	3	Supported
Actual Frame Duration	(0018,1242)	3	Supported
Preferred Playback Sequencing	(0018,1244)	3	Supported

#### 5.5.1.2 Multi-frame Module

**TABLE 5.5-3  
MULTI-FRAME MODULE ATTRIBUTES**

Attribute Name	Tag	Type	Attribute Description
Number of Frames	(0028,0008)	1	Is set to the number of frames in image
Frame Increment Pointer	(0028,0009)	1	Is set to Frame Time (0018,1063) or Frame Time Vector (0018,1065)

## **6. SC INFORMATION OBJECT IMPLEMENTATION**

### **6.1 INTRODUCTION**

This section specifies the use of the DICOM SC Image IOD to represent the information included in SC images produced by this implementation. Corresponding attributes are conveyed using the module construct. The contents of this section are:

6.2 - IOD Implementation

6.3 - IOD Entity-Relationship Model

6.4 - IOD Module Table

6.5 - IOD Module Definition

### **6.2 SC IOD IMPLEMENTATION**

This section defines the implementation of SC image information object.

### **6.3 SC ENTITY-RELATIONSHIP MODEL**

The Entity-Relationship diagram for the SC Image interoperability schema is shown in Illustration 6.3-1. In this figure, the following diagrammatic convention is established to represent the information organization:

- each entity is represented by a rectangular box
- each relationship is represented by a diamond shaped box.
- the fact that a relationship exists between two entities is depicted by lines connecting the corresponding entity boxes to the relationship boxes.

The relationships are fully defined with the maximum number of possible entities in the relationship shown. In other words, the relationship between Series and Image can have up to n Images per Series, but the Patient to Study relationship has 1 Study for each Patient (a Patient can have more than one Study on the system, however each Study will contain all of the information pertaining to that Patient).

ILLUSTRATION 6.3-1  
SC IMAGE ENTITY RELATIONSHIP DIAGRAM

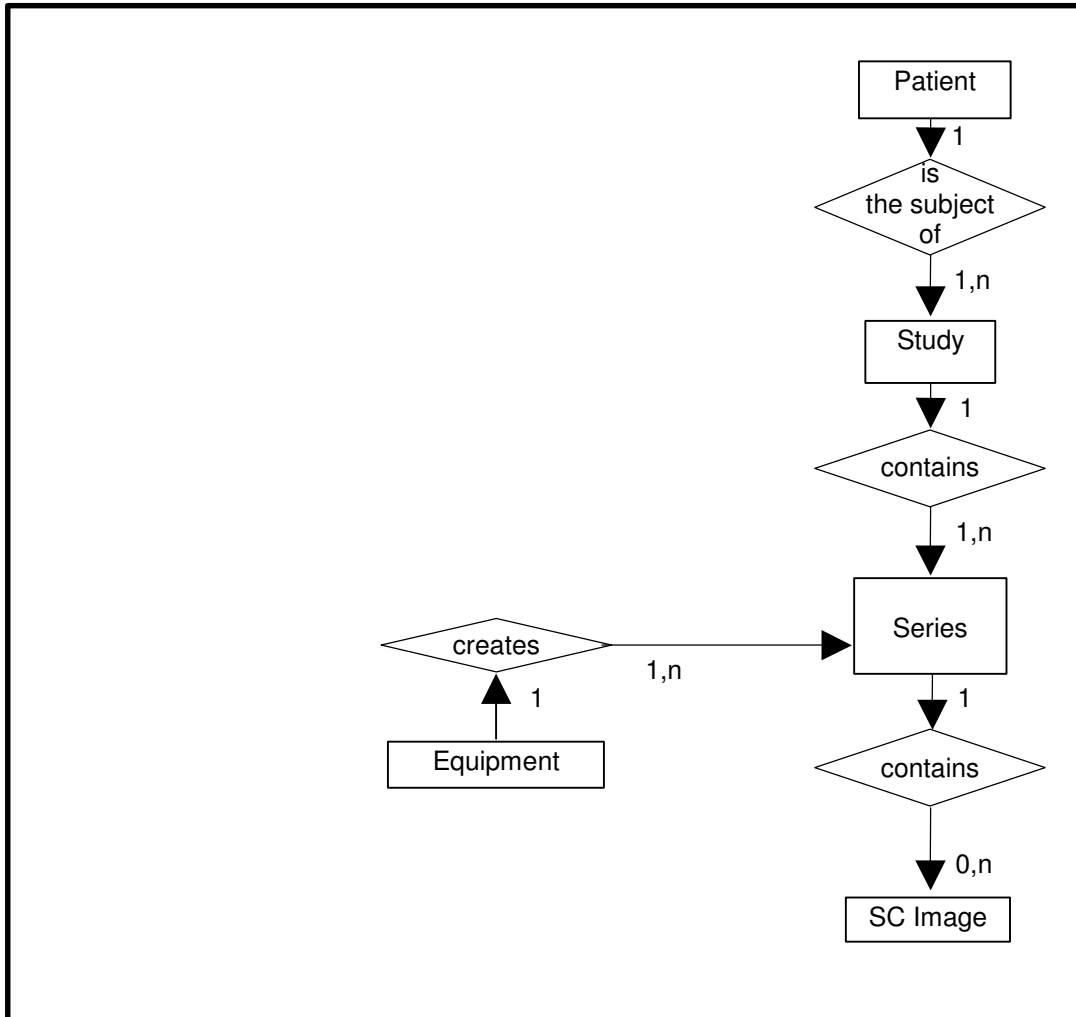

**6.3.1 Entity Descriptions**

Please refer to DICOM Standard Part 3 (Information Object Definitions) for a description of each of the entities contained within the SC Information Object.

**6.3.2 Vivid7 Mapping of DICOM Entities**

TABLE 6.3-1  
MAPPING OF DICOM ENTITIES TO VIVID7 ENTITIES

DICOM	Vivid7 Entity
Patient	Patient
Study	Exam
Series	Exam
Image	Image
Frame	Not Applicable



**6.4 IOD MODULE TABLE**

Within an entity of the DICOM SC IOD, attributes are grouped into related set of attributes. A set of related attributes is termed a module. A module facilitates the understanding of the semantics concerning the attributes and how the attributes are related with each other. A module grouping does not infer any encoding of information into datasets.

Table 6.4-1 identifies the defined modules within the entities, which comprise the DICOM SC IOD. Modules are identified by Module Name.

See DICOM Part 3 for a complete definition of the entities, modules, and attributes.

**TABLE 6.4-1**  
**SC IMAGE IOD MODULES**

<b>Entity Name</b>	<b>Module Name</b>	<b>Reference</b>
Patient	Patient	4.5.1.1
Study	General Study	4.5.2.1
	Patient Study	4.5.2.2
Series	General Series	4.5.3.1
	Equipment	General Equipment
Equipment	SC Equipment	6.5.1.1
	Image	General Image
Image	Image Pixel	4.5.5.2
	SC Image	6.5.1.2
Image	Overlay Plane	Not used
	Modality LUT	Not used
Image	VOI LUT	4.5.5.5
	SOP Common	4.5.6.1

**6.5 INFORMATION MODULE DEFINITIONS**

Please refer to DICOM Standard Part 3 (Information Object Definitions) for a description of each of the entities and modules contained within the SC Information Object.

The following modules are included to convey Enumerated Values, Defined Terms, and Optional Attributes supported. Type 1 & Type 2 Attributes are also included for completeness and to define what values they may take and where these values are obtained. It should be noted that they are the same ones as defined in the DICOM Standard Part 3 (Information Object Definitions).

**6.5.1 SC Modules**

This Section describes SC Equipment, and Image Modules. These Modules contain attributes that are specific to SC Image IOD.

**6.5.1.1 SC Equipment Module**

This Module describes equipment used to convert images into a DICOM format.

**TABLE 6.5-2**  
**SC IMAGE EQUIPMENT MODULE ATTRIBUTES**

<b>Attribute Name</b>	<b>Tag</b>	<b>Type</b>	<b>Attribute Description</b>
Conversion Type	(0008,0064)	1	Set to WSD
Modality	(0008,0060)	3	Defined Value "US" used.
Secondary Capture Device ID	(0018,1010)	3	Defined Value "Vivid7"
Secondary Capture Device Manufacturer	(0018,1016)	3	Implementation defined string "GE Vingmed Ultrasound"
Secondary Capture Device Manufacturer's Model Name	(0018,1018)	3	Implementation defined string "Vivid7"
Secondary Capture Device Software Version	(0018,1019)	3	Is set to Vivid7 software version
Video Image Format Acquired	(0018,1022)	3	Not used
Digital Image Format Acquired	(0018,1023)	3	Not used

**6.5.1.2 SC Image Module**

The table in this Section contains IOD attributes that describe SC images.

**TABLE 6.5-3**  
**SC IMAGE MODULE ATTRIBUTES**

<b>Attribute Name</b>	<b>Tag</b>	<b>Type</b>	<b>Attribute Description</b>
Date of Secondary Capture	(0018,1012)	3	Image capture date
Time of Secondary Capture	(0018,1014)	3	Image capture time

## **7. SR INFORMATION OBJECT IMPLEMENTATION**

### **7.1 INTRODUCTION**

This section specifies the use of the DICOM Comprehensive SR IOD to represent results produced by this implementation. Corresponding attributes are conveyed using the module construct. The contents of this section are:

7.2- IOD Implementation

7.3 - IOD Entity-Relationship Model

7.4 - IOD Module Table

7.5 - IOD Module Definition

In this section, supported means that tag is sent with value.

### **7.2 COMPREHENSIVE SR IOD IMPLEMENTATION**

This section defines the implementation of Comprehensive SR information object.

### **7.3 COMPREHENSIVE SR ENTITY-RELATIONSHIP MODEL**

The Entity-Relationship diagram for the Comprehensive SR interoperability schema is shown in Illustration 4.3-1. In this figure, the following diagrammatic convention is established to represent the information organization:

- each entity is represented by a rectangular box
- each relationship is represented by a diamond shaped box.
- the fact that a relationship exists between two entities is depicted by lines connecting the corresponding entity boxes to the relationship boxes.

The relationships are fully defined with the maximum number of possible entities in the relationship shown. In other words, the relationship between Series and SR Documents can have up to n SR Documents per Series, but the Patient to Study relationship has 1 Study for each Patient (a Patient can have more than one Study on the system, however each Study will contain all of the information pertaining to that Patient).

ILLUSTRATION 7.3-1  
COMPREHENSIVE SR ENTITY RELATIONSHIP DIAGRAM

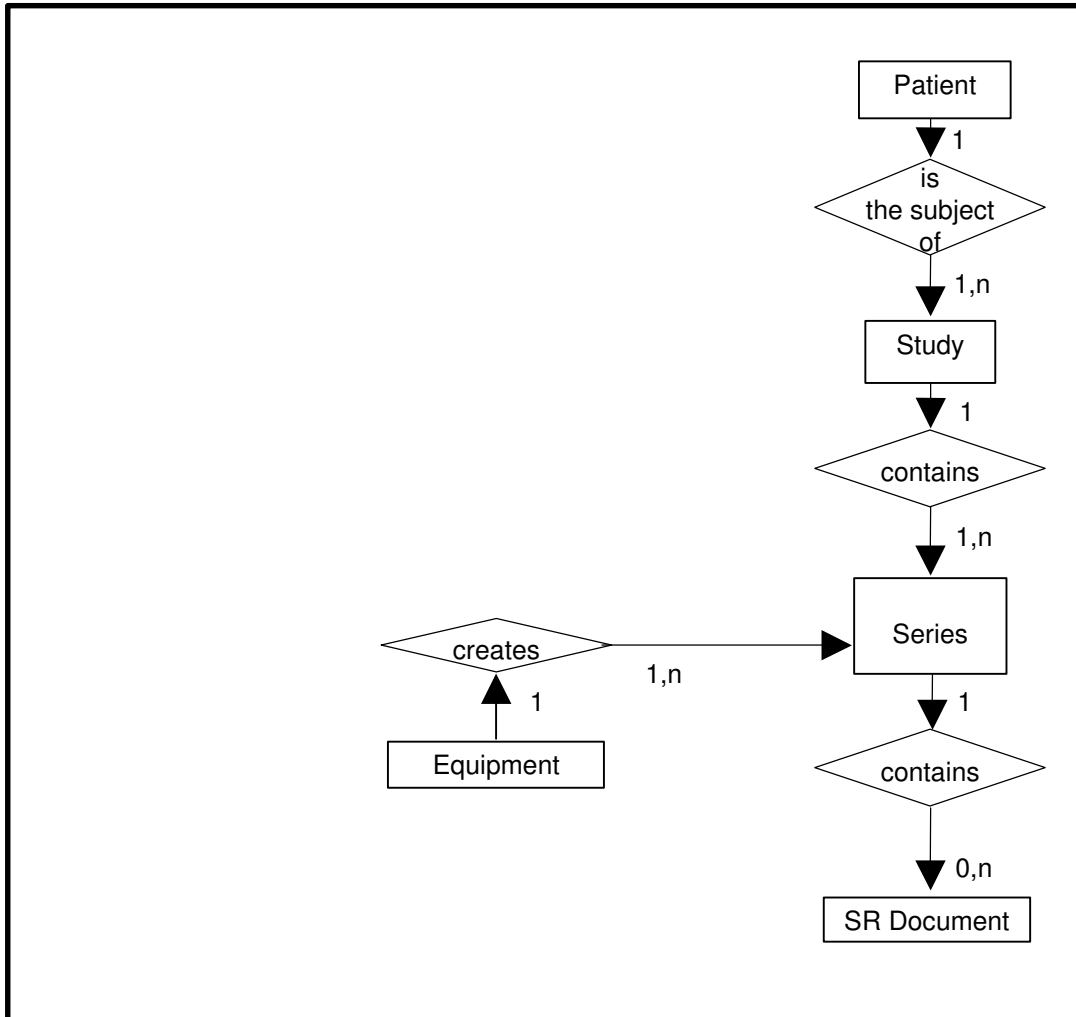

### 7.3.1 Entity Descriptions

Please refer to DICOM Standard Part 3 (Information Object Definitions) for a description of each of the entities contained within the Comprehensive SR Information Object.

### 7.3.2 Vivid7 Mapping of DICOM Entities

TABLE 7.3-1  
MAPPING OF DICOM ENTITIES TO VIVID7 ENTITIES

DICOM	Vivid7 Entity
Patient	Patient
Study	Exam
Series	Exam
SR Document	Results

**7.4 IOD MODULE TABLE**

Within an entity of the DICOM Comprehensive SR IOD, attributes are grouped into related set of attributes. A set of related attributes is termed a module. A module facilitates the understanding of the semantics concerning the attributes and how the attributes are related with each other. A module grouping does not infer any encoding of information into data sets.

Table 4.4-1 identifies the defined modules within the entities, which comprise the DICOM Comprehensive SR IOD. Modules are identified by Module Name.

See DICOM Part 3 for a complete definition of the entities, modules, and attributes.

**TABLE 7.4-1**  
**COMPREHENSIVE SR IMAGE IOD MODULES**

<b>Entity Name</b>	<b>Module Name</b>	<b>Reference</b>
Patient	Patient	4.5.1.1
	Specimen Identification	Not used
Study	General Study	4.5.2.1
	Patient Study	4.5.2.2
Series	SR Document Series	7.5.1
Equipment	General Equipment	4.5.4.1
Document	SR Document General	7.5.2
	SR Document Content	7.5.3
	SOP Common	4.5.6.1

**7.5 INFORMATION MODULE DEFINITIONS**

Please refer to DICOM Standard Part 3 (Information Object Definitions) for a description of each of the entities and modules contained within the Comprehensive SR Information Object.

The following modules are included to convey Enumerated Values, Defined Terms, and Optional Attributes supported. Type 1 & Type 2 Attributes are also included for completeness and to define what values they may take and where these values are obtained. It should be noted that they are the same ones as defined in the DICOM Standard Part 3 (Information Object Definitions).

7.5.1 SR Document Series Module

TABLE 7.5-1  
SR DOCUMENT SERIES MODULE

Attribute Name	Tag	Type	Attribute Description
Modality	(0008,0060)	1	Defined Term "SR" used.
Series Instance UID	(0020,000E)	1	Uniquely generated by the equipment
Series Number	(0020,0011)	1	Internal number which is incremented for each new series within a study.
Referenced Performed Procedure Step Sequence	(0008,1111)	2	Not used.
>Referenced SOP Class UID	(0008,1150)	1C	Not used.
>Referenced SOP Instance UID	(0008,1155)	1C	Not used.

7.5.2 SR Document General Module

TABLE 7.5-2  
SR DOCUMENT GENERAL MODULE

Attribute Name	Tag	Type	Attribute Description
Instance Number	(0020,0013)	1	Internal number which is incremented for each new SR document within a series.
Completion Flag	(0040,A491)	1	Defined Term "PARTIAL" used.
Completion Flag Description	(0040,A492)	3	Not used
Verification Flag	(0040,A493)	1	Defined Term "UNVERIFIED" used.
Content Date	(0008,0023)	1	Date of creation
Content Time	(0008,0033)	1	Time of creation
Verifying Observer Sequence	(0040,A073)	1C	Not used
>Verifying Observer Name	(0040,A075)	1	
>Verifying Observer Identification Code Sequence	(0040,A088)	2	
>>Include 'Code Sequence Macro'			
>Verifying Organization	(0040,A027)	1	
>Verification DateTime	(0040,A030)	1	
Predecessor Documents Sequence	(0040,A360)	1C	Not used.
>Include 'SOP Instance Reference Macro'			
Identical Documents Sequence	(0040,A525)	1C	Not used
>Include 'SOP Instance Reference Macro'			
Referenced Request Sequence	(0040,A370)	1C	

>Study Instance UID	(0020,000D)	1	Taken from Study Instance UID in General Study Module
>Referenced Study Sequence	(0008,1110)	2	Not used
>>Referenced SOP Class UID	(0008,1150)	1	Not used
>>Referenced SOP Instance UID	(0008,1155)	1	Not used
>Accession Number	(0008,0050)	2	Taken from Accession Number in General Study Module
>Placer Order Number/Imaging Service Request	(0040,2016)	2	Not used
>Filler Order Number/Imaging Service Request	(0040,2017)	2	Not used
>Requested Procedure ID	(0040,1001)	2	Taken from worklist if it is there
>Requested Procedure Description	(0032,1060)	2	Taken from worklist if it is there
>Requested Procedure Code Sequence	(0032,1064)	2	Not used.
>>Include 'Code Sequence Macro'			
Performed Procedure Code Sequence	(0040,A372)	2	Not used.
>Include 'Code Sequence Macro'			
Current Requested Procedure Evidence Sequence	(0040,A375)	1C	Not used.
>Study Instance UID	(0020,000D)	1	
>Referenced Series Sequence	(0008,1115)	1	
>>Series Instance UID	(0020,000E)	1	
>>Retrieve AE Title	(0008,0054)	3	Not used
>>Storage Media File-Set ID	(0088,0130)	3	Not used
>>Storage Media File-Set UID	(0088,0140)	3	Not used
>>Referenced SOP Sequence	(0008,1199)	1	
>>>Referenced SOP Class UID	(0008,1150)	1	
>>>Referenced SOP Instance UID	(0008,1155)	1	
Pertinent Other Evidence Sequence	(0040,A385)	1C	Not used
>Include 'SOP Instance Reference Macro'			

7.5.3 SR Document Content Module

The SR Document Content Module is described in the following table.

TABLE 7.5-2  
SR DOCUMENT CONTENT MODULE ATTRIBUTES

Attribute Name	Tag	Type	Attribute Description
----------------	-----	------	-----------------------

Observation DateTime	(0040,A032)	1C	Not used
Content Template Sequence	(0040,A504)	1C	Template id 5200 from DCMR.
> <i>'Template Identification Macro'</i>			
Value Type	(0040,A040)	1	CONTAINER
Continuity of Content	(0040,A050)	1C	SEPARATE
Concept Name Code Sequence	(0040,A043)	1C	“Adult Echocardiography Procedure Report”
> <i>'Code Sequence Macro'</i>			
<i>Concept Value attribute(s)</i>			Not used for CONTAINER
Content Sequence	(0040,A730)	1C	See template “Adult Echocardiography Procedure Report”.
> Relationship Type	(0040,A010)	1	See template “Adult Echocardiography Procedure Report”.
> Referenced Content Item Identifier	(0040,DB73)	1C	Not used
> <i>SR Document Content Module</i>			See template “Adult Echocardiography Procedure Report”. The only optional template items filled in are Echo Sections for the measurements in the exam (including Wall Motion Scoring). In template Echo Section (TID 5202), row 4 (Image Mode) is used for the Measurement group modifier.

**7.5.3.1 SR Document Content Descriptions**

**7.5.3.1.1 Content Template**

Vivid7 supports the following root Templates for SR SOP Instances created by Vivid7.

**TABLE 7.5-3  
SR ROOT TEMPLATES**

SOP Class	Template ID	Template Name	Use
Comprehensive SR	5200	“Adult Echocardiography Procedure Report”	Create

The mapping from the product’s internal measurement names to DICOM SR encoding is in chapter 14.



**7.6 STANDARD EXTENDED AND PRIVATE DATA ATTRIBUTES**

If so configured, the product will send exam information in private data elements designated by the Private Creator element:

<b>Element Name</b>	<b>Tag</b>	<b>VR</b>	<b>VM</b>	<b>Description</b>
Private Creator	6005,00xx	LO	1	GEMS_Ultrasound_ExamGroup_001

This means that all private tags starting with 6005,xx will belong to the GEMS\_Ultrasound\_ExamGroup\_001.

**7.7 STANDARD EXTENDED AND PRIVATE CONTEXT GROUPS**

Not applicable.

**7.8 STANDARD EXTENDED AND PRIVATE TEMPLATES**

Not applicable.

**7.8.1 Standard Extended Templates**

Not applicable.

**7.8.2 Private Templates**

Not applicable.

## 8. BASIC DIRECTORY INFORMATION OBJECT IMPLEMENTATION

### 8.1 INTRODUCTION

This section specifies the use of the DICOM Basic Directory IOD to represent the information included in directories produced by this implementation. Corresponding attributes are conveyed using the module construct. The contents of this section are:

8.2 - IOD Implementation

8.3 - IOD Entity-Relationship Model

8.4- IOD Module Table

8.5 - IOD Module Definition

### 8.2 BASIC DIRECTORY IOD IMPLEMENTATION

This section defines the implementation of Basic Directory information object.

### 8.3 BASIC DIRECTORY ENTITY-RELATIONSHIP MODEL

The Entity-Relationship diagram for the Basic Directory interoperability schema is shown in Illustration 8.3-1. In this figure, the following diagrammatic convention is established to represent the information organization:

- each entity is represented by a rectangular box
- each relationship is represented by a diamond shaped box
- the fact that a relationship exists between two entities is depicted by lines connecting the corresponding entity boxes to the relationship boxes.

#### 8.3.1 Vivid7 Mapping of DICOM entities

**TABLE 8.3-1**  
**MAPPING OF DICOM ENTITIES TO VIVID7 ENTITIES**

DICOM	Vivid7
Patient	Patient
Study	Exam
Series	Exam
Image or SR Document	Image or Results

ILLUSTRATION 8.3-1  
BASIC DIRECTORY ENTITY RELATIONSHIP DIAGRAM

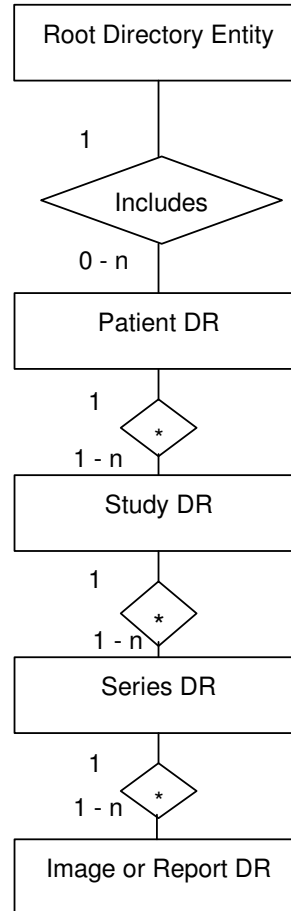

#### 8.4 IOD MODULE TABLE

Within an entity of the Basic Directory IOD, attributes are grouped into related set of attributes. A set of related attributes is termed a module. A module facilitates the understanding of the semantics concerning the attributes and how the attributes are related with each other. A module grouping does not infer any encoding of information into datasets.

Table 8.4-1 identifies the defined modules within the entities, which comprise the Basic Directory IOD. Modules are identified by Module Name.

See DICOM Part 3 for a complete definition of the entities, modules, and attributes.

**TABLE 8.4-1  
BASIC DIRECTORY IOD MODULES**

Entity Name	Module Name	Reference
File Set Identification	File Set Identification	8.5.1.1
Directory Information	Directory Information	8.5.2.1

The Directory Information Module is created when initializing the media. If it already exists, the existing information is not changed regarding patient, study, series or image/result data.

An existing Directory Information Module may have been obtained from application entities using removable media. These instances are external to this conformance claim and the origin of the SOP instances is outside the scope of this claim.

## 8.5 INFORMATION MODULE DEFINITIONS

Please refer to DICOM Standard Part 3 (Information Object Definitions) for a description of each of the entities and modules contained within the Basic Directory Information Object.

The following modules are included to convey Enumerated Values, Defined Terms, and Optional Attributes supported. Type 1 & Type 2 Attributes are also included for completeness and to define what values they may take and where these values are obtained. It should be noted that they are the same ones as defined in the DICOM Standard Part 3 (Information Object Definitions).

### 8.5.1 Common File Set identification Modules

#### 8.5.1.1 File Set identification Module

**TABLE 8.5-1  
FILE-SET IDENTIFICATION MODULE**

Attribute Name	Tag	Type	Attribute Description
File-set ID	(0004,1130)	2	Has NULL value
File-set Descriptor File ID	(0004,1141)	3	Not used
Specific Character Set of File-set Descriptor File	(0004,1142)	1C	Not used

### 8.5.2 Common Directory Information Modules

#### 8.5.2.1 Directory Information Module

**TABLE 8.5-2  
DIRECTORY INFORMATION MODULE**

Attribute Name	Tag	Type	Attribute Description
Offset of the First Directory Record of the Root Directory Entity	(0004,1200)	1	Is set
Offset of the Last Directory Record of the Root Directory Entity	(0004,1202)	1	Is set

Attribute Name	Tag	Type	Attribute Description
File-set Consistency Flag	(0004,1212)	1	FSC/FSU: Has the value 0000H: no known inconsistencies
Directory Record Sequence	(0004,1220)	2	Is created by FSC
>Offset of the Next Directory Record	(0004,1400)	1C	Is set
>Record In-use Flag	(0004,1410)	1C	FSC/FS: Is set to FFFFH FSR: A value of 0000H: imply skipping this record Read: A value of 0000H: the record is skipped
>Offset of Referenced Lower-Level Directory Entity	(0004,1420)	1C	Is set
>Directory Record Type	(0004,1430)	1C	The values support by FSC and FSU are PATIENT STUDY SERIES IMAGE SR DOCUMENT
>Private Record UID	(0004,1432)	1C	Not used
>Referenced File ID	(0004,1500)	1C	Is set if Directory Record Type is IMAGE or SR DOCUMENT Contains the file path consisting of 5 elements: 1. "GEMS_IMG" (if IMAGE) or "GEMS_REP" (if SR DOCUMENT) 2. Month of exam 3. Day of exam 4. Patient initials and time of exam 5. Time stamp
>MRDR Directory Record Offset	(0004,1504)	1C	A MRDR is not created by an FSC or FSU.
>Referenced SOP Class UID in File	(0004,1510)	1C	Is set to the SOP class UID in File
>Referenced SOP Instance UID in File	(0004,1511)	1C	Is set to the SOP instance UID in File
>Referenced Transfer Syntax UID in File	(0004,1512)	1C	Is set to the Transfer Syntax UID in File
>Record Selection Keys			See 8.5.3.

8.5.3 Definition of Specific Directory Records

8.5.3.1 Patient Directory Record Definition

TABLE 8.5-3  
PATIENT KEYS

Key	Tag	Type	Attribute Description
Specific Character Set	(0008,0005)	1C	Is filled in by FSC and FSU as in chapter 4, 5, 6 and 7.
Patient's Name	(0010,0010)	2	Is filled in by FSC and FSU as in chapter 4, 5, 6 and 7.
Patient ID	(0010,0020)	1	Is filled in by FSC and FSU as in chapter 4, 5, 6 and 7. If empty, a Patient Id is created by the equipment.
Patient's Birth Date	(0010,0030)	3	Is filled in by FSC and FSU as in chapter 4, 5, 6 and 7.
Patient's Sex	(0010,0040)	3	Is filled in by FSC and FSU as in chapter 4, 5, 6 and 7.
Referenced Patient Sequence	(0008,1120)	3	Is filled in by FSC and FSU as in chapter 4, 5, 6 and 7.
>Referenced SOP Class UID	(0008,1150)	1C	Is filled in by FSC and FSU as in chapter 4, 5, 6 and 7.
>Referenced SOP Instance UID	(0008,1155)	1C	Is filled in by FSC and FSU as in chapter 4, 5, 6 and 7.
Patient's Birth Time	(0010,0032)	3	Is filled in by FSC and FSU as in chapter 4, 5, 6 and 7.
Other Patient Ids	(0010,1000)	3	Is filled in by FSC and FSU as in chapter 4, 5, 6 and 7.
Other Patient Names	(0010,1001)	3	Is filled in by FSC and FSU as in chapter 4, 5, 6 and 7.
Ethnic Group	(0010,2160)	3	Is filled in by FSC and FSU as in chapter 4, 5, 6 and 7.
Patient Comments	(0010,4000)	3	Is filled in by FSC and FSU as in chapter 4, 5, 6 and 7.

8.5.3.2 Study Directory Record Definition

TABLE 8.5-4  
STUDY KEYS

Key	Tag	Type	Attribute Description
Specific Character Set	(0008,0005)	1C	Is filled in by FSC and FSU as in chapter 4, 5, 6 and 7.
Study Instance UID	(0020,000D)	1C	Is filled in by FSC and FSU as in chapter 4, 5, 6 and 7.
Study Date	(0008,0020)	1	Is filled in by FSC and FSU as in chapter 4, 5, 6 and 7. If empty, a Study Date is created by the equipment.

Key	Tag	Type	Attribute Description
Study Time	(0008,0030)	1	Is filled in by FSC and FSU as in chapter 4, 5, 6 and 7. If empty, a Study Time is created by the equipment.
Referring Physician's Name	(0008,0090)	2	Is filled in by FSC and FSU as in chapter 4, 5, 6 and 7.
Study ID	(0020,0010)	1	Is filled in by FSC and FSU as in chapter 4, 5, 6 and 7. If empty, a Study Id is created by the equipment.
Accession Number	(0008,0050)	2	Is filled in by FSC and FSU as in chapter 4, 5, 6 and 7.
Study Description	(0008,1030)	2	Is filled in by FSC and FSU as in chapter 4, 5, 6 and 7.
Physician(s) of Record	(0008,1048)	3	Is filled in by FSC and FSU as in chapter 4, 5, 6 and 7.
Name of Physician(s) Reading Study	(0008,1060)	3	Is filled in by FSC and FSU as in chapter 4, 5, 6 and 7.
Referenced Study Sequence	(0008,1110)	3	Is filled in by FSC and FSU as in chapter 4, 5, 6 and 7.
>Referenced SOP Class UID	(0008,1150)	1C	Is filled in by FSC and FSU as in chapter 4, 5, 6 and 7.
>Referenced SOP Instance UID	(0008,1155)	1C	Is filled in by FSC and FSU as in chapter 4, 5, 6 and 7.
Admitting Diagnoses Description	(0008,1080)	3	Is filled in by FSC and FSU as in chapter 4, 5, 6 and 7.
Patient's Age	(0010,1010)	3	Is filled in by FSC and FSU as in chapter 4, 5, 6 and 7.
Patient's Size	(0010,1020)	3	Is filled in by FSC and FSU as in chapter 4, 5, 6 and 7.
Patient's Weight	(0010,1030)	3	Is filled in by FSC and FSU as in chapter 4, 5, 6 and 7.
Occupation	(0010,2180)	3	Is filled in by FSC and FSU as in chapter 4, 5, 6 and 7.
Additional Patient's History	(0010,21B0)	3	Is filled in by FSC and FSU as in chapter 4, 5, 6 and 7.

### 8.5.3.3 Series Directory Record Definition

**TABLE 8.5-5  
SERIES KEYS**

Key	Tag	Type	Attribute Description
Specific Character Set	(0008,0005)	1C	Is filled in by FSC or FSU as contained in the image or SR document message, if one of the tags contains extended characters
Modality	(0008,0060)	1	Is filled in by FSC and FSU as in chapter 4, 5, 6 and 7.

Key	Tag	Type	Attribute Description
Series Instance UID	(0020,000E)	1	Is filled in by FSC and FSU as in chapter 4, 5, 6 and 7.
Series Number	(0020,0011)	1	Is filled in by FSC and FSU as in chapter 4, 5, 6 and 7. If empty, a Series Number is created by the equipment.
Icon Image Sequence	(0088,0200)	3	Not used.
Series Date	(0008,0021)	3	Is filled in by FSC and FSU as in chapter 4, 5, 6 and 7 if instance is IMAGE.
Series Time	(0008,0031)	3	Is filled in by FSC and FSU as in chapter 4, 5, 6 and 7 if instance is IMAGE.
Performing Physicians' Name	(0008,1050)	3	Is filled in by FSC and FSU as in chapter 4, 5, 6 and 7 if instance is IMAGE.
Protocol Name	(0018,1030)	3	Is filled in by FSC and FSU as in chapter 4, 5, 6 and 7 if instance is IMAGE.
Series Description	(0008,103E)	3	Is filled in by FSC and FSU as in chapter 4, 5, 6 and 7 if instance is IMAGE.
Operator's Name	(0008,1070)	3	Is filled in by FSC and FSU as in chapter 4, 5, 6 and 7 if instance is IMAGE.
Referenced Performed Procedure Step Sequence	(0008,1111)	3	Is filled in by FSC and FSU as in chapter 4, 5, 6 and 7.
>Referenced SOP Class UID	(0008,1150)	1C	Is filled in by FSC and FSU as in chapter 4, 5, 6 and 7.
>Referenced SOP Instance UID	(0008,1155)	1C	Is filled in by FSC and FSU as in chapter 4, 5, 6 and 7.
Request Attributes Sequence	(0040,0275)	3	Is filled in by FSC and FSU as in chapter 4, 5, 6 and 7 if instance is IMAGE.
>Requested Procedure ID	(0040,1001)	1C	Is filled in by FSC and FSU as in chapter 4, 5, 6 and 7 if instance is IMAGE.
>Scheduled Procedure Step ID	(0040,0009)	1C	Is filled in by FSC and FSU as in chapter 4, 5, 6 and 7 if instance is IMAGE.
>Scheduled Procedure Step Description	(0040,0007)	3	Is filled in by FSC and FSU as in chapter 4, 5, 6 and 7 if instance is IMAGE.
>Scheduled Protocol Code Sequence	(0040,0008)	3	Is filled in by FSC and FSU as in chapter 4, 5, 6 and 7 if instance is IMAGE.



Key	Tag	Type	Attribute Description
>>Include 'Code Sequence Macro'			Is filled in by FSC and FSU as in chapter 4, 5, 6 and 7 if instance is IMAGE.
Performed Procedure Step ID	(0040,0253)	3	Is filled in by FSC and FSU as in chapter 4, 5, 6 and 7 if instance is IMAGE.
Performed Procedure Step Start Date	(0040,0244)	3	Is filled in by FSC and FSU as in chapter 4, 5, 6 and 7 if instance is IMAGE.
Performed Procedure Step Start Time	(0040,0245)	3	Is filled in by FSC and FSU as in chapter 4, 5, 6 and 7 if instance is IMAGE.
Performed Procedure Step Description	(0040,0254)	3	Is filled in by FSC and FSU as in chapter 4, 5, 6 and 7 if instance is IMAGE.
Performed Protocol Code Sequence	(0040,0260)	3	Is filled in by FSC and FSU as in chapter 4, 5, 6 and 7 if instance is IMAGE.
>Include 'Code Sequence Macro'			
Manufacturer	(0008,0070)	2	Is filled in by FSC and FSU as in chapter 4, 5, 6 and 7.
Institution Name	(0008,0080)	3	Is filled in by FSC and FSU as in chapter 4, 5, 6 and 7.
Station Name	(0008,1010)	3	Is filled in by FSC and FSU as in chapter 4, 5, 6 and 7.
Institutional Department Name	(0008,1040)	3	Is filled in by FSC and FSU as in chapter 4, 5, 6 and 7.
Manufacturer's Model Name	(0008,1090)	3	Is filled in by FSC and FSU as in chapter 4, 5, 6 and 7.
Software Versions	(0018,1020)	3	Is filled in by FSC and FSU as in chapter 4, 5, 6 and 7.

8.5.3.4 Image Directory Record Definition

TABLE 8.5-6  
IMAGE KEYS

Key	Tag	Type	Attribute Description
Specific Character Set	(0008,0005)	1C	Is filled in by FSC and FSU as in chapter 4, 5, 6 and 7.
Instance Number	(0020,0013)	1	Is filled in by FSC and FSU as in chapter 4, 5, 6 and 7. If empty, a Instance Number is created by the equipment.
Icon Image Sequence	(0088,0200)	3	Not used
Content Date	(0008,0023)	3	Is filled in by FSC and FSU as in chapter 4, 5, 6 and 7.
Content Time	(0008,0033)	3	Is filled in by FSC and FSU as in chapter 4, 5, 6 and 7.

Image Type	(0008,0008)	3	Is filled in by FSC and FSU as in chapter 4, 5, 6 and 7.
Rows	(0028,0010)	3	Is filled in by FSC and FSU as in chapter 4, 5, 6 and 7.
Columns	(0028,0011)	3	Is filled in by FSC and FSU as in chapter 4, 5, 6 and 7.
Number Of Frames	(0028,0008)	3	Is filled in by FSC and FSU as in chapter 4, 5, 6 and 7.
Photometric Interpretation	(0028,0004)	3	Is filled in by FSC and FSU as in chapter 4, 5, 6 and 7.
Referenced Transfer Syntax UID in File	(0004,1512)	3	Is set to the Transfer Syntax UID in File
Referenced SOP Instance UID in File	(0004,1511)	3	Is set to the SOP instance UID in File
Referenced SOP Class in File	(0004,1510)	3	Is set to the SOP class UID in File
Contrast/Bolus Agent	(0018,0010)	2	Is filled in by FSC and FSU as in chapter 4, 5, 6 and 7.
Lossy Image Compression	(0028,2110)	3	Is filled in by FSC and FSU as in chapter 4, 5, 6 and 7.
Lossy Image Compression Ratio	(0028,2112)	3	Is filled in by FSC and FSU as in chapter 4, 5, 6 and 7.

**8.5.3.5 Report Directory Record Definition**

**TABLE 8.5-7**  
**REPORT KEYS**

<b>Key</b>	<b>Tag</b>	<b>Type</b>	<b>Attribute Description</b>
Specific Character Set	(0008,0005)	1C	Is filled in by FSC and FSU as in chapter 4, 5, 6 and 7.
Instance Number	(0020,0013)	1	Is filled in by FSC and FSU as in chapter 4, 5, 6 and 7. If empty, a Instance Number is created by the equipment.
Content Date	(0008,0023)	3	Is filled in by FSC and FSU as in chapter 4, 5, 6 and 7.
Content Time	(0008,0033)	3	Is filled in by FSC and FSU as in chapter 4, 5, 6 and 7.
Referenced Transfer Syntax UID in File	(0004,1512)	3	Is set to the Transfer Syntax UID in File
Referenced SOP Instance UID in File	(0004,1511)	3	Is set to the SOP instance UID in File
Referenced SOP Class in File	(0004,1510)	3	Is set to the SOP class UID in File
Completion Flag	(0040,A491)	3	Is filled in by FSC and FSU as in chapter 4, 5, 6 and 7.
Verification Flag	(0040,A493)	3	Is filled in by FSC and FSU as in chapter 4, 5, 6 and 7.

**8.5.3.6 Private Directory Record Definition**

Not used.

**8.5.3.7 Multi-Referenced File Directory Record Definition**

Not used.

**8.6 PRIVATE DATA DICTIONARY**

If so configured, the product will send ultrasound raw data information in private data elements designated by the Private Creator element:

Element Name	Tag	VR	VM	Description
Private Creator	7FE1,00xx	LO	1	GEMS_Ultrasound_MovieGroup_001

This means that all private tags starting with 7FE1,xx will belong to the GEMS\_Ultrasound\_MovieGroup\_001.

If so configured, the product will send preview image in private data elements designated by the Private Creator element:

Element Name	Tag	VR	VM	Description
Private Creator	6003,00xx	LO	1	GEMS_Ultrasound_ImageGroup_001

This means that all private tags starting with 6003,xx will belong to the GEMS\_Ultrasound\_ImageGroup\_001.

If so configured, the product will send exam information in private data elements designated by the Private Creator element:

Element Name	Tag	VR	VM	Description
Private Creator	6005,00xx	LO	1	GEMS_Ultrasound_ExamGroup_001

This means that all private tags starting with 6005,xx will belong to the GEMS\_Ultrasound\_ExamGroup\_001.

## **9. MODALITY WORKLIST INFORMATION MODEL DEFINITION**

### **9.1 INTRODUCTION**

This section specifies the use of the DICOM Modality Worklist Information Model used to organize data and against which a Modality Worklist Query will be performed. The contents of this section are:

9.2- Information Model Description

9.3- Information Model Entity-Relationship Model

9.4- Information Model Module Table

9.5- Information Model Keys

### **9.2 MODALITY WORKLIST INFORMATION MODEL DESCRIPTION**

This section defines the implementation of Modality Worklist Information Model.

### **9.3 MODALITY WORKLIST INFORMATION MODEL ENTITY-RELATIONSHIP MODEL**

The Entity-Relationship diagram for the Modality Worklist Information Model schema is shown in Illustration 9.3-1. It represents the information that composes a Worklist Item. In this figure, the following diagrammatic convention is established to represent the information organization:

- Each entity is represented by a rectangular box.
- Each relationship is represented by a diamond shaped box.
- The fact that a relationship exists between two entities is depicted by lines connecting the corresponding entity boxes to the relationship boxes.

ILLUSTRATION 9.3-1  
MODALITY WORKLIST INFORMATION MODEL E/R DIAGRAM

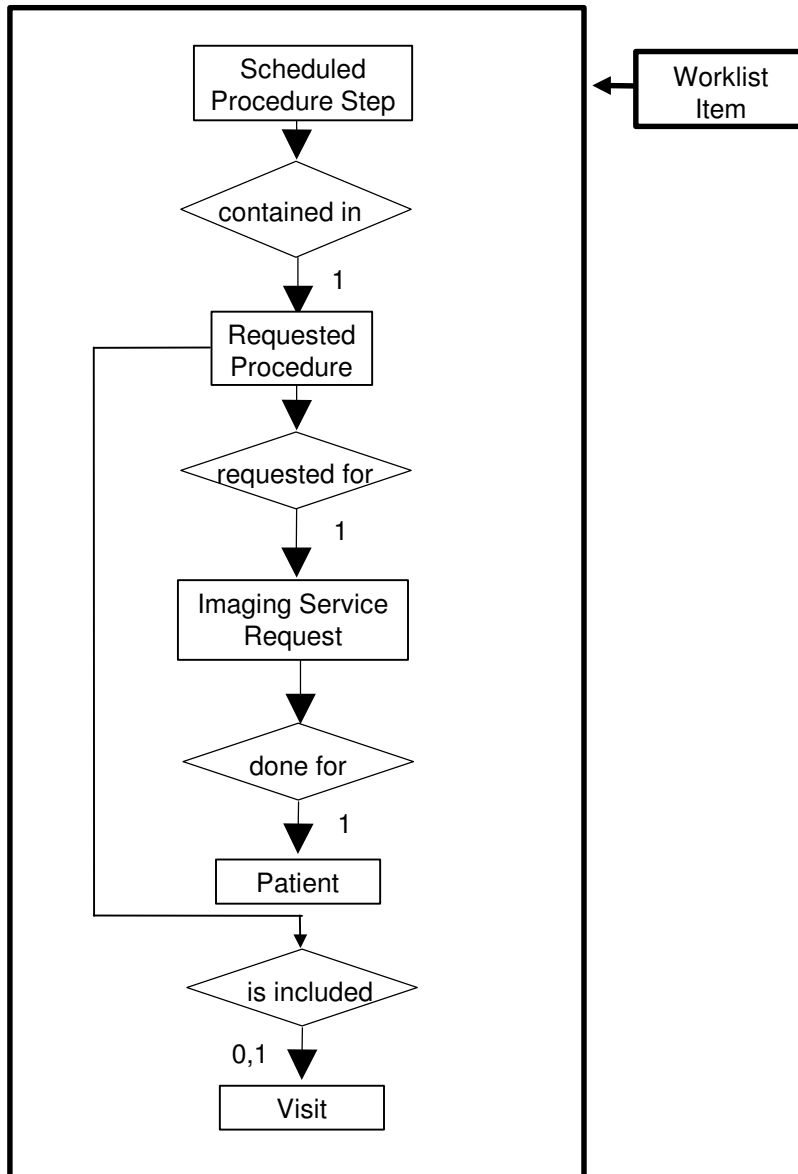

### 9.3.1 Entity Descriptions

Please refer to DICOM Standard PS 3.3. (Information Object Definitions) and PS 3.4 (Service Class Specifications) for a description of each of the Entities contained within the Modality Worklist Information Model.

#### 9.3.1.1 Scheduled Procedure Step

Schedule Procedure Step is implemented in a basic form to allow for the user to retrieve a subset of attributes.

**9.3.1.2 Requested Procedure Entity Description**

Requested Procedure Step is implemented in a basic form to allow for the user to retrieve a subset of attributes.

**9.3.1.3 Imaging Service Request Entity Description**

Image Service is implemented in a basic form to allow for the user to retrieve a subset of attributes.

**9.3.1.4 Visit Entity Description**

Visit Entity is implemented in a basic form to allow for the user to retrieve a subset of attributes.

**9.3.1.5 Patient Entity Description**

Patient Entity Description is implemented in a basic form to allow for the user to retrieve a subset of attributes.

**9.3.2 Vivid7 Mapping of DICOM entities**

**TABLE 9.3-1**  
**MAPPING OF DICOM ENTITIES TO VIVID7 ENTITIES**

DICOM	Vivid7 Entity
Scheduled Procedure Step	Not Applicable
Requested Procedure	Exam
Imaging Service Request	Exam
Visit	Not Applicable
Patient	Patient

**9.4 INFORMATION MODEL MODULE TABLE**

Within an entity of the DICOM Modality Worklist Information Model, attributes are grouped into related set of attributes. A set of related attributes is termed a module. A module facilitates the understanding of the semantics concerning the attributes and how the attributes are related with each other. A module grouping does not infer any encoding of information into datasets.

Table 9.4-1 identifies the defined modules within the entities that comprise the DICOM Modality Worklist Information Model. Modules are identified by Module Name.

See DICOM PS 3.3 and PS 3.4 for a complete definition of the entities, modules, and attributes.

**TABLE 9.4-1**  
**MODALITY WORKLIST INFORMATION MODEL MODULES**

<b>Entity Name</b>	<b>Module Name</b>	<b>Reference</b>
Scheduled Procedure Step	SOP Common	9.5.2.1
	Scheduled Procedure Step	9.5.2.2
Requested Procedure	Requested Procedure	9.5.3.1
Imaging Service Request	Imaging Service Request	9.5.4.1
Visit	Visit Identification	9.5.5.1
	Visit Status	9.5.5.2
	Visit Relationship	9.5.5.3
	Visit Admission	Not Used
Patient	Patient Relationship	Not Used
	Patient Identification	9.5.6.1
	Patient Demographic	9.5.6.2
	Patient Medical	9.5.6.3

## **9.5 INFORMATION MODEL KEYS**

Please refer to DICOM Standard PS 3.3. (Information Object Definitions) and PS 3.4 (Service Class Specifications) for a description of each of the Entities contained within the Modality Worklist Information Model.

The following Module descriptions are included to specify what data elements are supported and what type of matching can be applied. It should be noted that they are the same ones as defined in the DICOM Standard PS 3.4 (Service Class Specifications).

The term Instance is used for Images and Results in examinations, that are based on Worklist entries.

### **9.5.1 Supported Matching**

Following are the types of matching that can be requested by the implementation:

- Single Value Matching.
- Wild Card Matching.
- Range of date.

Fields with “Filtering is supported” in the Matching column can be controlled from the Search screen. This means that the user can filter the downloaded C-FIND result, to view a limited set of the result.

All non-required matching fields can be configured in Config screen to be either enabled, enabled with a constant value or disabled. The constant value will be used as entered by user.

9.5.2 Scheduled Procedure Step Entity

9.5.2.1 SOP Common Module

TABLE 9.5-1  
SOP COMMON MODULE ATTRIBUTES

Attribute Name	Tag	Expected Matching Key Type	Expected Returned Key Type	Mapped into Instance/MPP S	Matching
Specific Character Set	(0008,0005)	O	1C	Yes/Yes	Attribute is supported if the query contains matching keys in other than the default character repertoire. ISO_IR 100 is supported in responses.

9.5.2.2 Scheduled Procedure Step Module

TABLE 9.5-2  
SCHEDULED PROCEDURE STEP MODULE ATTRIBUTES

Attribute Name	Tag	Expected Matching Key Type	Expected Returned Key Type	Mapped into Instance/MPP S	Matching
Scheduled Procedure Step Sequence	(0040,0100)	R	1	No/No	Matching is supported.
>Scheduled Station AE Title	(0040,0001)	R	1	No/No	Matching is supported.
>Scheduled Procedure Step Start Date	(0040,0002)	R	1	No/No	Matching is supported. Filtering is supported.
>Scheduled Procedure Step Start Time	(0040,0003)	R	1	No/No	Matching is supported.
>Modality	(0008,0060)	R	1	Yes/Yes (but always "US")	Matching is supported.
>Scheduled Performing Physician's Name	(0040,0006)	R	2	Yes/Yes (to Performing Physician's Name)	Matching is supported.
>Scheduled Procedure Step Description	(0040,0007)	O	1C	Yes/Yes	Matching is supported.
>Scheduled Station Name	(0040,0010)	O	2	No/No	Matching is supported.



>Scheduled Procedure Step Location	(0040,0011)	O	2	No/No	Matching is supported.
>Scheduled Procedure Step ID	(0040,0009)	O	1	Yes/Yes	Matching is supported.
>Scheduled Protocol Code Sequence	(0040,0008)	O	1C	Yes/Yes	Matching is supported.

### 9.5.3 Requested Procedure Entity

#### 9.5.3.1 Requested Procedure Module

TABLE 9.5-3  
REQUESTED PROCEDURE MODULE ATTRIBUTES

Attribute Name	Tag	Expected Matching Key Type	Expected Returned Key Type	Mapped into Instance/MP PS	Matching
Requested Procedure ID	(0040,1001)	O	1	Yes/Yes (to Requested Procedure ID and Study ID)	Matching is supported. Filtering is supported.
Requested Procedure Description	(0032,1060)	O	1C	Yes/Yes (to Study Description and Requested Procedure Description)	Matching is supported.
Requested Procedure Code Sequence	(0032,1064)	O	1C	No/Yes	Matching is supported.
Requested Procedure Comments	(0040,1400)	O	3	No/No	Matching is supported.
Study Instance UID	(0020,000D)	O	1	Yes/Yes	Matching is supported.
Referenced Study Sequence	(0008,1110)	O	2	Yes/Yes	Matching is supported.
>Referenced SOP Class UID	(0008,1150)	O	1C	Yes/Yes	Matching is supported.
>Referenced SOP Instance UID	(0008,1155)	O	1C	Yes/Yes	Matching is supported.

Names of Intended Recipients of Results	(0040,1010)	O	3	Yes/No (to Physician(s) of Record)	Matching is supported.
---	-------------	---	---	------------------------------------	------------------------

**9.5.4 Imaging Service Request Entity**

**9.5.4.1 Imaging Service Request Module**

**TABLE 9.5-4  
IMAGING SERVICE REQUEST MODULE ATTRIBUTES**

Attribute Name	Tag	Expected Matching Key Type	Expected Returned Key Type	Mapped into Instance/MPP S	Matching
Accession Number	(0008,0050)	O	2	Yes/Yes	Matching is supported. Filtering is supported.
Referring Physician's Name	(0008,0090)	O	2	Yes/No	Matching is supported.
Imaging Service Request Comments	(0040,2400)	O	3	No/No	Matching is supported.
Requesting Physician	(0032,1032)	O	2	No/No	Matching is supported.
Requesting Service	(0032,1033)	O	3	No/No	Matching is supported.

**9.5.5 Visit Entity**

**9.5.5.1 Visit Identification**

**TABLE 9.5-5  
VISIT IDENTIFICATION MODULE ATTRIBUTES**

Attribute Name	Tag	Expected Matching Key Type	Expected Returned Key Type	Mapped into Instance/MP PS	Matching
Admission ID	(0038,0010)	O	2	Yes/Yes	Matching is supported.
Issuer of Admission ID	(0038,0011)	O	2	Yes/Yes	Matching is supported.

9.5.5.2 Visit Status

TABLE 9.5-6  
VISIT STATUS MODULE ATTRIBUTES

Attribute Name	Tag	Expected Matching Key Type	Expected Returned Key Type	Mapped into Instance/MPPS	Matching
Current Patient Location	(0038,0300)	O	2	No/No	Matching is supported.

9.5.5.3 Visit Relationship

TABLE 9.5-7  
VISIT RELATIONSHIP MODULE ATTRIBUTES

Attribute Name	Tag	Expected Matching Key Type	Expected Returned Key Type	Mapped into Instance/MPPS	Matching
Referenced Patient Sequence	(0008,1120)	O	2	Yes/Yes	Matching is supported.
>Referenced SOP Class UID	(0008,1150)	O	2	Yes/Yes	Matching is supported.
>Referenced SOP Instance UID	(0008,1155)	O	2	Yes/Yes	Matching is supported.

9.5.6 Patient Entity

9.5.6.1 Patient Identification

TABLE 9.5-8  
PATIENT IDENTIFICATION MODULE ATTRIBUTES

Attribute Name	Tag	Expected Matching Key Type	Expected Returned Key Type	Mapped into Instance/MPPS	Matching
Patient's Name	(0010,0010)	R	1	Yes/Yes	Matching is supported. Filtering is supported.
Patient ID	(0010,0020)	R	1	Yes/Yes	Matching is supported. Filtering is supported.
Other Patient Ids	(0010,1000)	O	3	Yes/No	Matching is supported.

9.5.6.2 Patient Demographic

**TABLE 9.5-9  
PATIENT DEMOGRAPHIC MODULE ATTRIBUTES**

Attribute Name	Tag	Expected Matching Key Type	Expected Returned Key Type	Mapped into Instance/MP PS	Matching
Patients Birth Date	(0010,0030)	O	2	Yes/Yes	Matching is supported. Filtering is supported.
Patients Birth Time	(0010,0032)	O	3	Yes/No	Matching is supported.
Patient's Sex	(0010,0040)	O	2	Yes/Yes	Matching is supported Filtering is supported.
Patient's Size	(0010,1020)	O	3	Yes/No	Matching is supported.
Patient's Weight	(0010,1030)	O	2	Yes/No	Matching is supported.
Ethnic Group	(0010,2160)	O	3	Yes/No	Matching is supported.
Patient Comments	(0010,4000)	O	3	Yes/No	Matching is supported.

**9.5.6.3 Patient Medical**

**TABLE 9.5-10  
PATIENT MEDICAL MODULE ATTRIBUTES**

Attribute Name	Tag	Expected Matching Key Type	Expected Returned Key Type	Mapped into Instance/MP PS	Matching
Additional Patient History	(0010,21B0)	O	3	Yes/No	Matching is supported.
Contrast Allergies	(0010,2210)	O	2	No/No	Matching is supported.
Medical Alerts	(0010,2000)	O	2	No/No	Matching is supported.
Pregnancy Status	(0010,21C0)	O	2	No/No	Matching is supported.

## 10. MODALITY PERFORMED PROCEDURE STEP SOP CLASS DEFINITION

### 10.1 INTRODUCTION

This section of the DICOM Conformance Statement specifies the Modality Performed Procedure Step SOP Class, the optional attributes and service elements supported, the valid range of values for mandatory and optional attributes, and the status code behavior.

### 10.2 MODALITY PERFORMED PROCEDURE STEP SOP CLASS DEFINITION

In this section, supported means that tag is sent with value if entered by user or from worklist.

#### 10.2.1 IOD Description

This is the description of the DICOM tags to be sent for Modality Performed Procedure Step SOP class:

#### Modality Performed Procedure Step Sop Class N-CREATE, N-SET and Final State Attributes

Attribute Name	Tag	Req. Type N-CREATE	Req. Type N-SET
<b>Performed Procedure Step Relationship</b>			
Scheduled Step Attribute Sequence	(0040,0270)	1	Not allowed
>Study Instance UID	(0020,000D)	1	Not allowed
>Referenced Study Sequence	(0008,1110)	2, supported	Not allowed
>>Referenced SOP Class UID	(0008,1150)	1C, supported	Not allowed
>>Referenced SOP Instance UID	(0008,1155)	1C, supported	Not allowed
>Accession Number	(0008,0050)	2, supported	Not allowed
>Placer Order Number/Imaging Service Request	(0040,2016)	3, not supported	Not allowed
>Filler Order Number/Imaging Service Request	(0040,2017)	3, not supported	Not allowed
>Requested Procedure ID	(0040,1001)	2, supported	Not allowed
>Requested Procedure Description	(0032,1060)	2, supported	Not allowed
>Scheduled Procedure Step ID	(0040,0009)	2, supported	Not allowed
>Scheduled Procedure Step Description	(0040,0007)	2, supported	Not allowed
>Scheduled Protocol Code Sequence	(0040,0008)	2, supported	Not allowed
>>Include 'Code Sequence Macro'			
Patient's Name	(0010,0010)	2, supported	Not allowed
Patient ID	(0010,0020)	2, supported	Not allowed

Attribute Name	Tag	Req. Type N-CREATE	Req. Type N-SET
Patient's Birth Date	(0010,0032)	2, supported	Not allowed
Patient's Sex	(0010,0040)	2, supported	Not allowed
Referenced Patient Sequence	(0008,1120)	2, supported	Not allowed
>Referenced SOP Class UID	(0008,1150)	1C, supported	Not allowed
>Referenced SOP Instance UID	(0008,1155)	1C, supported	Not allowed
Admission Id	(0038,0010)	3, supported	Not allowed
Issuer of Admission Id	(0038,0011)	3, supported	Not allowed
<b>Performed Procedure Step Information</b>			
Performed Procedure Step ID	(0040,0253)	1	Not allowed
Performed Station AE Title	(0040,0241)	1	Not allowed
Performed Station Name	(0040,0242)	2, supported	Not allowed
Performed Location	(0040,0243)	2, supported (Institution Name, truncated if necessary to 16 characters)	Not allowed
Performed Procedure Step Start Date	(0040,0244)	1	Not allowed
Performed Procedure Step Start Time	(0040,0245)	1	Not allowed
Performed Procedure Step Status	(0040,0252)	1	3, supported
Performed Procedure Step Description	(0040,0254)	2, supported	3, supported
Performed Procedure Type Description	(0040,0255)	2, always empty	3, always empty
Procedure Code Sequence	(0008,1032)	2, supported	3, supported
>Include 'Code Sequence Macro'			
Performed Procedure Step End Date	(0040,0250)	2, always empty	3, supported
Performed Procedure Step End Time	(0040,0251)	2, always empty	3, supported
<b>Image Acquisition Results</b>			
Modality	(0008,0060)	1	Not allowed
Study ID	(0020,0010)	2, supported	Not allowed
Performed Protocol Code Sequence	(0040,0260)	2, always empty	3, always empty
>Include 'Code Sequence Macro'			
Performed Series Sequence	(0040,0340)	2, always empty	3, supported
>Performing Physician's Name	(0008,1050)	2C (Required if Sequence Item is present)	2C (Required if Sequence Item is present)
>Protocol Name	(0018,1030)	1C (Required if Sequence Item is present)	1C (Required if Sequence Item is present)

<b>Attribute Name</b>	<b>Tag</b>	<b>Req. Type N-CREATE</b>	<b>Req. Type N-SET</b>
>Operator's Name	(0008,1070)	2C (Required if Sequence Item is present)	2C (Required if Sequence Item is present)
>Series Instance UID	(0020,000E)	1C (Required if Sequence Item is present)	1C (Required if Sequence Item is present)
>Series Description	(0008,103E)	2C (Required if Sequence Item is present)	2C (Required if Sequence Item is present)
>Retrieve AE Title	(0008,0054)	2C (Required if Sequence Item is present)	2C (Required if Sequence Item is present)
>Referenced Image Sequence	(0008,1140)	2C (Required if Sequence Item is present)	2C (Required if Sequence Item is present)
>>Referenced SOP Class UID	(0008,1150)	1C (Required if Sequence Item is present)	1C (Required if Sequence Item is present)
>>Referenced SOP Instance UID	(0008,1155)	1C (Required if Sequence Item is present)	1C (Required if Sequence Item is present)
>Referenced Non-Image Composite SOP Instance Sequence	(0040,0220)	2C (Required if Sequence Item is present)	2C (Required if Sequence Item is present)
>>Referenced SOP Class UID	(0008,1150)	1C (Required if Sequence Item is present)	1C (Required if Sequence Item is present)
>>Referenced SOP Instance UID	(0008,1155)	1C (Required if Sequence Item is present)	1C (Required if Sequence Item is present)
>Referenced Frame Number	(0008,1160)	3, not supported	3, not supported

10.2.2 Operations

10.2.2.1 Action Information

TABLE 10.2-11  
MODALITY PERFORMED PROCEDURE STEP - ACTION INFORMATION

Request Type	Attribute	Tag	Requirement Type SCU
N-CREATE	Scheduled Step Attribute Sequence	(0040,0270)	1
	>Study Instance UID	(0020,000D)	1
	>Referenced Study Sequence	(0008,1110)	2, supported
	>>Referenced SOP Class UID	(0008,1150)	1C, supported
	>>Referenced SOP Instance UID	(0008,1155)	1C, supported
	>Accession Number	(0008,0050)	2, supported
	>Placer Order Number/Imaging Service Request	(0040,2016)	3, not supported
	>Filler Order Number/Imaging Service Request	(0040,2017)	3, not supported
	>Requested Procedure ID	(0040,1001)	2, supported
	>Requested Procedure Description	(0032,1060)	2, supported
	>Scheduled Procedure Step ID	(0040,0009)	2, supported
	>Scheduled Procedure Step Description	(0040,0007)	2, supported
	Scheduled Protocol Code Sequence	(0040,0008)	2, supported
	>Include 'Code Sequence Macro'		
	Patient's Name	(0010,0010)	2, supported
	Patient ID	(0010,0020)	2, supported
	Patient's Birth Date	(0010,0032)	2, supported
	Patient's Sex	(0010,0040)	2, supported
	Referenced Patient Sequence	(0008,1120)	2, supported



	>Referenced SOP Class UID	(0008,1150)	1C, supported
	>Referenced SOP Instance UID	(0008,1155)	1C, supported
	Admission Id	(0038,0010)	3, supported
	Issuer of Admission Id	(0038,0011)	3, supported
	Performed Procedure Step Start Time	(0040,0245)	1
	Performed Procedure Step Status	(0040,0252)	1
	Performed Procedure Step Description	(0040,0254)	2, supported
	Performed Procedure Type Description	(0040,0255)	2, always empty
	Procedure Code Sequence	(0008,1032)	2, supported
	>Include 'Code Sequence Macro'		
	Performed Procedure Step End Date	(0040,0250)	2, always empty
	Performed Procedure Step End Time	(0040,0251)	2, always empty
	Modality	(0008,0060)	1
	Study ID	(0020,0010)	2, supported
	Performed Protocol Code Sequence	(0040,0260)	2, always empty
	>Include 'Code Sequence Macro'		
	Performed Series Sequence	(0040,0340)	2, always empty
	>Performing Physician's Name	(0008,1050)	2C (Required if Sequence Item is present)
	>Protocol Name	(0018,1030)	1C (Required if Sequence Item is present)
	>Operator's Name	(0008,1070)	2C (Required if Sequence Item is present)
	>Series Instance UID	(0020,000E)	1C (Required if Sequence Item is present)

	>Series Description	(0008,103E)	2C (Required if Sequence Item is present)
	>Retrieve AE Title	(0008,0054)	2C (Required if Sequence Item is present)
	>Referenced Image Sequence	(0008,1140)	2C (Required if Sequence Item is present)
	>>Referenced SOP Class UID	(0008,1150)	1C (Required if Sequence Item is present)
	>>Referenced SOP Instance UID	(0008,1155)	1C (Required if Sequence Item is present)
	>Referenced Non-Image Composite SOP Instance Sequence	(0040,0220)	2C (Required if Sequence Item is present)
	>>Referenced SOP Class UID	(0008,1150)	1C (Required if Sequence Item is present)
	>>Referenced SOP Instance UID	(0008,1155)	1C (Required if Sequence Item is present)
	>Referenced Frame Number	(0008,1160)	3, not supported
N-SET	Performed Procedure Step Status	(0040,0252)	3, supported
	Performed Procedure Step Description	(0040,0254)	3, supported
	Performed Procedure Type Description	(0040,0255)	3, always empty
	Procedure Code Sequence	(0008,1032)	3, supported
	>Include 'Code Sequence Macro'		
	Performed Procedure Step End Date	(0040,0250)	3, supported
	Performed Procedure Step End Time	(0040,0251)	3, supported
	Performed Protocol Code Sequence	(0040,0260)	3, always empty
	>Include 'Code Sequence Macro'		
	Performed Series Sequence	(0040,0340)	3, supported

	>Performing Physician's Name	(0008,1050)	2C (Required if Sequence Item is present)
	>Protocol Name	(0018,1030)	1C (Required if Sequence Item is present)
	>Operator's Name	(0008,1070)	2C (Required if Sequence Item is present)
	>Series Instance UID	(0020,000E)	1C (Required if Sequence Item is present)
	>Series Description	(0008,103E)	2C (Required if Sequence Item is present)
	>Retrieve AE Title	(0008,0054)	2C (Required if Sequence Item is present)
	>Referenced Image Sequence	(0008,1140)	2C (Required if Sequence Item is present)
	>>Referenced SOP Class UID	(0008,1150)	1C (Required if Sequence Item is present)
	>>Referenced SOP Instance UID	(0008,1155)	1C (Required if Sequence Item is present)
	>Referenced Non-Image Composite SOP Instance Sequence	(0040,0220)	2C (Required if Sequence Item is present)
	>>Referenced SOP Class UID	(0008,1150)	1C (Required if Sequence Item is present)
	>>Referenced SOP Instance UID	(0008,1155)	1C (Required if Sequence Item is present)
	>Referenced Frame Number	(0008,1160)	3, not supported

#### 10.2.2.2 Service Class User Behavior

Vivid7 sends N-CREATE when first image in examination is acquired or when the exam is ended for the case where there are no images

Vivid7 sends N-SET after the exam is ended. The N-SET will include all acquired images' UIDs and the status of COMPLETED or DISCONTINUED.

#### 10.2.2.3 Status Codes

No Service Class specific status values are defined for the N-ACTION Service. See PS 3.7 for general response status codes.

## 11. STORAGE COMMITMENT PUSH MODEL SOP CLASS DEFINITION

### 11.1 INTRODUCTION

This section of the DICOM Conformance Statement specifies the Storage Commitment Push Model SOP Class, the optional attributes and service elements supported, the valid range of values for mandatory and optional attributes, and the status code behavior.

### 11.2 STORAGE COMMITMENT PUSH MODEL SOP CLASS DEFINITION

#### 11.2.1 IOD Description

##### 11.2.1.1 STORAGE COMMITMENT MODULE

**TABLE 11.2-1  
 STORAGE COMMITMENT MODULE**

Attribute Name	Tag	Attribute Description
Transaction UID	(0008,1195)	Uniquely generated by the equipment
Retrieve AE Title	(0008,0054)	Not used
Storage Media File-Set ID	(0088,0130)	Not used
Storage Media File-Set UID	(0088,0140)	Not used
Referenced SOP Sequence	(0008,1199)	Supported
>Referenced SOP Class UID	(0008,1150)	Supported
>Referenced SOP Instance UID	(0008,1155)	Supported
>Retrieve AE Title	(0008,0054)	Not used
>Storage Media File-Set ID	(0088,0130)	Not used
>Storage Media File-Set UID	(0088,0140)	Not used
Failed SOP Sequence	(0008,1198)	Supported
>Referenced SOP Class UID	(0008,1150)	Supported
>Referenced SOP Instance UID	(0008,1155)	Supported
>Failure Reason	(0008,1197)	Supported

#### 11.2.2 DIMSE Service Group

DIMSE Service Element	Usage SCU/SCP
N-EVENT-REPORT	M/M
N-ACTION	M/M

11.2.3 Operations

11.2.3.1 Action Information

TABLE 11.2-3  
STORAGE COMMITMENT REQUEST - ACTION INFORMATION

Action Type Name	Action Type ID	Attribute	Tag	Requirement Type SCU/SCP
Request Storage Commitment	1	Transaction UID	(0008,1195)	1/1
		Storage Media File-Set ID	(0088,0130)	Not used
		Storage Media File-Set UID	(0088,0140)	Not used
		Referenced SOP Sequence	(0008,1199)	1/1
		>Referenced SOP Class UID	(0008,1150)	1/1
		>Referenced SOP Instance UID	(0008,1155)	1/1
		>Storage Media File-Set ID	(0088,0130)	Not used
		>Storage Media File-Set UID	(0088,0140)	Not used

11.2.3.2 Service Class User Behavior

Vivid7 sends the N-ACTION primitive (Storage Commitment Request) after successful exam save to a DICOM Storage SCP.

Vivid7 may request storage commitment for all generated SOP Class UIDs:

Ultrasound Multi-frame Image Storage	1.2.840.10008.5.1.4.1.1.3.1
Ultrasound Multi-frame Image Storage (Retired)	1.2.840.10008.5.1.4.1.1.3
Ultrasound Image Storage	1.2.840.10008.5.1.4.1.1.6.1

Ultrasound Image Storage (Retired)	1.2.840.10008.5.1.4.1.1.6
Secondary Capture Image Storage	1.2.840.10008.5.1.4.1.1.7
Comprehensive Structured Report	1.2.840.10008.5.1.4.1.1.88.33

The association for the N-ACTION is disconnected after processing the response. Thus, the N-EVENT-REPORT must be sent on a separate association.

The Referenced Study Component Sequence Attribute is not supported.

The Transaction UID is valid for two days. If no answer is received, the request will be removed without warning the user.

The optional Storage Media File-Set ID & UID Attributes in the N-ACTION are not supported.

On receipt of an unsuccessful N-ACTION Response Status Code from the SCP, the request will be put in a holding queue for the user to manually retry the request.

### **11.2.3.3 Status Codes**

No Service Class specific status values are defined for the N-ACTION Service. See PS 3.7 for general response status codes.

### **11.2.4 Notifications**

Vivid7 will only listen for an N-EVENT-REPORT from the SCP in a new association on the listen port for Verification and Storage Commitment.

11.2.4.1 Event Information

TABLE 11.2-4  
STORAGE COMMITMENT RESULT - EVENT INFORMATION

Event Type Name	Event Type ID	Attribute	Tag	Requirement Type SCU/SCP
Storage Commitment Request Successful	1	Transaction UID	(0008,1195)	-/1
		Retrieve AE Title	(0008,0054)	Not used
		Storage Media File-Set ID	(0088,0130)	Not used
		Storage Media File-Set UID	(0088,0140)	Not used
		Referenced SOP Sequence	(0008,1199)	-/1
		>Referenced SOP Class UID	(0008,1150)	-/1
		>Referenced SOP Instance UID	(0008,1155)	-/1
		>Retrieve AE Title	(0008,0054)	Not used
		>Storage Media File-Set ID	(0088,0130)	Not used
		>Storage Media File-Set UID	(0088,0140)	Not used
Storage Commitment Request Complete - Failures Exist	2	Transaction UID	(0008,1195)	-/1
		Retrieve AE Title	(0008,0054)	Not used
		Storage Media File-Set ID	(0088,0130)	Not used
		Storage Media File-Set UID	(0088,0140)	Not used
		Referenced SOP Sequence	(0008,1199)	-/1C
		>Referenced SOP Class UID	(0008,1150)	-/1
		>Referenced SOP Instance UID	(0008,1155)	-/1
		>Retrieve AE Title	(0008,0054)	Not used
		>Storage Media File-Set ID	(0088,0130)	Not used
		>Storage Media File-Set UID	(0088,0140)	Not used
		Failed SOP Sequence	(0008,1198)	-/1

		>Referenced SOP Class UID	(0008,1150)	-/1
		>Referenced SOP Instance UID	(0008,1155)	-/1
		>Failure Reason	(0008,1197)	-/1

**11.2.4.2 Service Class User Behavior**

If a successful answer is received, the request will be removed without warning the user.

If a non-successful answer is received, the request will be left in the holding queue.

If no answer is received, the request will be removed without warning the user after two days.

**11.2.4.3 Status Codes**

No Service Class specific status values are defined for the N-EVENT-REPORT Service. See PS 3.7 for general response status code.



## **12. PRINT MANAGEMENT SOP CLASS DEFINITION**

### **12.1 INTRODUCTION**

This section of the DICOM Conformance Statement specifies the supported Print Management SOP and Meta SOP Classes, the optional attributes and service elements supported, the valid range of values for mandatory and optional attributes, and the status code behavior.

12.2 - Basic Print Management Meta SOP Classes

12.3 - Print Management SOP Class Definitions

12.4 - Print Management IODs

12.5 - IOD Module Definition

### **12.2 BASIC PRINT MANAGEMENT META SOP CLASSES**

The Basic Print Management Meta SOP Classes correspond with the minimum functionality that an implementation of the Print Management Service Class shall support.

Vivid7 supports the Basic Grayscale Print Management Meta SOP Class and the Basic Color Print Management Meta SOP Class. These are defined in Table 12.2.1-1 and Table 12.2.2-1.

#### **12.2.1 Basic Grayscale Print Management Meta SOP Class**

The Basic Grayscale Print Management Meta SOP Class is defined by the following set of supported SOP Classes.

**TABLE 12.2.1-1 BASIC GRAYSCALE PRINT MANAGEMENT META SOP CLASS**

<b>SOP Class Name</b>	<b>Usage SCU</b>	<b>Reference</b>
Basic Film Session SOP Class	M	see 12.3.1
Basic Film Box SOP Class	M	see 12.3.2
Basic Grayscale Image Box SOP Class	M	see 12.3.3.1
Printer SOP Class	M	see 12.3.4

#### **12.2.2 Basic Color Print Management Meta SOP Class**

The Basic Color Print Management Meta SOP Class is defined by the following set of supported SOP Classes

**TABLE 12.2.2-1 BASIC COLOR PRINT MANAGEMENT META SOP CLASS**

SOP Class Name	Usage SCU	Reference
Basic Film Session SOP Class	M	see 12.3.1
Basic Film Box SOP Class	M	see 12.3.2
Basic Color Image Box SOP Class	M	see 12.3.3.2
Printer SOP Class	M	see 12.3.4

**12.3 PRINT MANAGEMENT SOP CLASS DEFINITIONS**

**12.3.1 Basic Film Session SOP Class**

The Basic Film Session IOD describes the presentation parameters, which are common for all the films of a film session. The DIMSE services that are applicable to the IOD are shown in Table 12.3.1-1.

**TABLE 12.3.1-1 DIMSE SERVICE GROUP**

DIMSE Service Element	Usage SCU	Reference
N-CREATE	M	see 12.3.1.1.1
N-SET	U	see 12.3.1.1.2
N-DELETE	U	see 12.3.1.1.3
N-ACTION	U	see 12.3.1.1.4

**12.3.1.1 DIMSE Service Group**

**12.3.1.1.1 N-CREATE**

The N-CREATE DIMSE Service is used by Vivid7 to request that the SCP (printer) create a Film Session SOP Instance. Table 12.4.2-1 defines the Basic Film Session Presentation Module attributes used in this request.

**12.3.1.1.2 N-SET**

Not used in this implementation.

**12.3.1.1.3 N-DELETE**

Not used in this implementation.

**12.3.1.1.4 N-ACTION**

Not used in this implementation

**12.3.2 Basic Film Box SOP Class**

The Basic Film Box IOD is an abstraction of the presentation of one film of the film session. The DIMSE services that are applicable to the IOD are shown in Table 12.3.2-1.

TABLE 12.3.2-1 DIMSE SERVICE GROUP

DIMSE Service Element	Usage SCU	Reference
N-CREATE	M	see 12.3.2.1.1
N-ACTION	M	see 12.3.2.1.2
N-DELETE	U	see 12.3.2.1.3
N-SET	U	see 12.3.2.1.4

**12.3.2.1 DIMSE Service Group**

**12.3.2.1.1 N-CREATE**

The N-CREATE DIMSE Service is used by Vivid7 to request that the SCP create a Film Box SOP Instance. Table 12.4.2-1 defines the Basic Film Box Presentation Module attributes used in this request.

**12.3.2.1.2 N-ACTION**

The N-ACTION DIMSE Service is used by Vivid7 to request the SCP (printer) to print the number of copies configured by the user to a film of the film session.

**12.3.2.1.3 N-DELETE**

The N-DELETE DIMSE Service is used by Vivid7 to request the SCP (printer) to delete the complete Film Box. The root Film Box Instance UID is sent to the SCP to accomplish this.

**12.3.2.1.4 N-SET**

Not used in this implementation.

**12.3.3 Image Box SOP Class**

**12.3.3.1 Basic Grayscale Image Box SOP Class**

The Basic Grayscale Image Box IOD is an abstraction of the presentation of an image and image related data in the image area of a film. The DIMSE services that are applicable to the IOD are shown in Table 12.3.3-1.

TABLE 12.3.3-1 DIMSE SERVICE GROUP

DIMSE Service Element	Usage SCU	Reference
N-SET	M	see 12.3.3.1.1

**12.3.3.1.1 DIMSE Service Group (N-SET)**

The N-SET DIMSE Service is used by Vivid7 to update the Basic Grayscale Image Box SOP Instance. Table 12.5.2-5 defines the Basic Image Box Presentation Module attributes used.

### 12.3.3.2 Basic Color Image Box SOP Class

The Basic Color Image Box IOD is an abstraction of the presentation of an image and image related data in the image area of a film. The DIMSE services that are applicable to the IOD are shown in Table 12.3.3-2.

**TABLE 12.3.3-2 DIMSE SERVICE GROUP**

DIMSE Service Element	Usage SCU	Reference
N-SET	M	see 12.3.3.2.1

#### 12.3.3.2.1 DIMSE Service Group (N-SET)

The N-SET DIMSE Service is used by Vivid7 to update the Basic Color Image Box SOP Instance. Table 12.5.2-5 defines the Basic Image Box Presentation Module attributes used.

### 12.3.4 Printer SOP Class

The Printer IOD is an abstraction of the hard copy printer and is the basic Information Entity to monitor the status of the printer. The DIMSE services that are applicable to the IOD are shown in table 11.3.4-1.

#### 12.3.4.1 DIMSE Service Group

**TABLE 12.3.4-1 DIMSE SERVICE GROUP**

DIMSE Service Element	Usage SCU	Reference
N-EVENT-REPORT	M	see 11.3.4.1.1
N-GET	U	see 12.3.4.1.2

##### 12.3.4.1.1 N-EVENT\_REPORT

Vivid7 confirms the N-EVENT-REPORT initiated by the SCP (printer).

##### 12.3.4.1.2 N-GET

Used by Vivid7 to request the SCP to get a Printer SOP Instance. Table 12.5.2-6 defines the Printer Module attributes.

## 12.4 PRINT MANAGEMENT IODS

Within an entity of a DICOM Print Management, attributes are grouped into a related set of attributes. A set of related attributes is termed a module. A module facilitates the understanding of the semantics concerning the attributes and how the attributes are related with each other. A module grouping does not infer any encoding of information into datasets.

Table 12.4.1-1, Table 12.4.2-1, Table 12.4.3-1, and Table 12.4.4-1 identify the defined modules within the entities which comprise the DICOM Print Management Service IODs. Modules are identified by Module Name.

See DICOM for a complete definition of the entities, modules and attributes.

**12.4.1 Film Session IOD Module**

**TABLE 12.4.1-1 FILM SESSION IOD MODULES**

Module Name	Reference	Module Description
SOP Common Module	12.5.2.1	Contains SOP Common information
Basic Film Session Presentation Module	12.5.2.1	Contains Film Session presentation information
Basic Film Session Relationship Module	12.5.2.2	References to related SOPs

**12.4.2 Basic Film Box IOD Module Table**

**TABLE 12.4.2-1 BASIC FILM BOX IOD MODULES**

Module Name	Reference
SOP Common Module	12.5.1.1
Basic Film Box Presentation Module	12.5.2.3
Basic Film Box Relationship Module	12.5.2.2

**12.4.3 Basic Image Box IOD Module Table**

**TABLE 12.4.3-1 BASIC IMAGE BOX IOD MODULES**

Module Name	Reference
SOP Common Module	12.5.1.1
Image Box Pixel Presentation Module	12.5.2.5

**12.4.4 Printer IOD Module Table**

**TABLE 12.4.4-1 PRINTER IOD MODULES**

Module Name	Reference
SOP Common Module	12.5.1.1
Printer Module	12.5.2.6

**12.5 INFORMATION MODULE DEFINITIONS**

Please refer to DICOM Standard Part 3 (Information Object Definitions) for a description of each of the entities and modules that comprise the Print Management.

The following modules are included to convey Enumerated Values, Defined Terms, and Optional Attributes supported.

**12.5.1 General Modules**

**12.5.1.1 SOP Common Module**

This section defines the attributes that are required for proper functioning and identification of the associated SOP Instances. They do not specify any semantics about the Real-World Object represented by the IOD.

**TABLE 12.5.1-1 SOP COMMON MODULE ATTRIBUTES**

<b>Attribute Name</b>	<b>Tag</b>	<b>Type</b>	<b>Attribute Description</b>
SOP Class UID	(0008,0016)	1	Varies with Module Instance and DIMSE Service being used. 1.2.840.100011.5.1.1.1 (Film Session) 1.2.840.100011.5.1.1.2 (Film Box) 1.2.840.100011.5.1.1.4 (Image Box)
SOP Instance UID	(0008,0018)	1	Provided by SCP (printer).
Specific Character Set	(0008,0005)	1C	Not used as expanded or replacement character sets not used.
Instance Creation Date	(0008,0012)	3	Not used.
Instance Creation Time	(0008,0013)	3	Not used.
Instance Creator UID	(0008,0014)	3	Not used.

**12.5.2 Print Management Modules**

For all user configurable tags with no default, no value will be sent if the tag is not configured.

**12.5.2.1 Basic Film Session Presentation Module**

This section defines the attributes that are common for all films of a film session. The attributes described in table 11.5.2-1 apply when the N-CREATE DIMSE service is used.

**TABLE 12.5.2-1 BASIC FILM SESSION PRESENTATION MODULE ATTRIBUTES**

Attribute Name	Tag	USAGE (SCU)	Attribute Description
Number of Copies	(2000,0010)	U	Defined Terms used (user configurable): Default is 1. Max is 99.
Print Priority	(2000,0020)	U	Defined Terms used (user configurable): HIGH, MED, LOW. Default is HIGH.
Medium Type	(2000,0030)	U	Defined Terms used (user configurable): PAPER BLUE FILM CLEAR FILM Default is CLEAR FILM.
Film Destination	(2000,0040)	U	Defined Terms used (user configurable): MAGAZINE - default PROCESSOR
Film Session Label	(2000,0050)	U	User configurable. No default.
Memory Allocation	(2000,0060)	U	Not Used

**12.5.2.2 Basic Film Session Relationship Module**

**TABLE 12.5.2-2 BASIC FILM SESSION RELATIONSHIP MODULE ATTRIBUTES**

Attribute Name	Tag	USAGE (SCU)	Attribute Description
Referenced Film Box Sequence	(2000,0500)	U	Not used
>Referenced SOP Class UID	(0008,1150)	U	
>Referenced SOP Instance UID	(0008,1155)	U	

**12.5.2.3 Basic Film Box Presentation Module**

The attributes described in table 11.5.2-3 apply when the N-CREATE DIMSE service is used.

TABLE 12.5.2-3 BASIC FILM BOX PRESENTATION MODULE ATTRIBUTES

Attribute Name	Tag	USAGE (SCU)	Attribute Description
Image Display Format	(2010,0010)	M	Enumerated values used (user configurable): STANDARDX,Y, where X and Y can take values from 1 to 5. Default is STANDARD\1,1.
Annotation Display Format ID	(2010,0030)	U	Not used.
Film Orientation	(2010,0040)	U	Defined Terms used (user configurable): PORTRAIT - default LANDSCAPE
Film Size ID	(2000,0050)	U	Defined Terms used (user configurable): 8INX10IN - default 10INX12IN 10INX14IN 11INX14IN 14INX14IN 14INX17IN 24CMX24CM 24CMX30CM
Magnification Type	(2010,0060)	U	Defined Terms Used (user configurable): REPLICATE - default BILINEAR CUBIC NONE
Smoothing Type	(2010,0080)	U	Free form text entry field (user configurable) and only sent if Magnification Type is CUBIC. No default
Border Density	(2010,0100)	U	Defined Terms Used (user configurable): BLACK WHITE Default is BLACK.
Empty Image Density	(2010,0110)	U	Defined Terms Used (user configurable): BLACK WHITE Default is WHITE.
Min Density	(2010,0120)	U	User configurable. No default. Max is 999.



Max Density	(2010,0130)	U	User configurable. No default. Max is 999.
Trim	(2010,0140)	U	Enumerated Values Used (user configurable): YES NO Default is NO.
Configuration Information	(2010,0150)	U	User configurable. No default.

#### 12.5.2.4 Basic Film Box Relationship Module

This section defines the attributes that describe the common parameters, which apply for all images on a given sheet of film.

**TABLE 12.5.2-4 BASIC FILM BOX RELATIONSHIP MODULE ATTRIBUTES**

Attribute Name	Tag	USAGE (SCU)	Attribute Description
Referenced Film Session Sequence	(2010,0500)	M	
>Referenced SOP Class UID	(0008,1150)	M	1.2.840.10008.5.1.1.1
>Referenced SOP Instance UID	(0008,1155)	M	Provided by SCP (printer)
Referenced Image Box Sequence	(2010,0510)	U	Not used
>Referenced SOP Class UID	(0008,1150)	U	
>Referenced SOP Instance UID	(0008,1155)	U	
Referenced Basic Annotation Sequence	(2010,0520)	U	Not used
>Referenced SOP Class UID	(0008,1150)	U	
>Referenced SOP Instance UID	(0008,1155)	U	

#### 12.5.2.5 Image Box Pixel Presentation Module

The attributes described in table 11.5.2-5 apply when the DIMSE Service N-SET is used.

**TABLE 12.5.2-5 IMAGE BOX PIXEL PRESENTATION MODULE ATTRIBUTES**

Attribute Name	Tag	USAGE (SCU)	Attribute Description
Image Position	(2020,0010)	M	Based on the image display format.
Polarity	(2020,0020)	U	Defined term, NORMAL
Requested Image Size	(2020,0030)	U	Not sent
Basic Grayscale Image Sequence	(2020,0110)	M	
>Samples Per Pixel	(0028,0002)	M	Value = '1'
>Photometric Interpretation	(0028,0004)	M	Defined Term MONOCHROME2 used
>Rows	(0028,0010)	M	Value depends on scanning mode and configuration setup.
>Columns	(0028,0011)	M	Value depends on scanning mode and configuration setup.
>Pixel Aspect Ratio	(0028,0034)	MC	Not used
>Bits Allocated	(0028,0100)	M	Value always = 0008H
>Bits Stored	(0028,0101)	M	Value always = 0008H
>High Bit	(0028,0102)	M	Value always = 0007H
>Pixel Representation	(0028,0103)	M	Defined Value '0' - unsigned integer
>Pixel Data	(7FE0,0010)	M	
Basic Color Image Sequence	(2020,0111)	M	
>Samples Per Pixel	(0028,0002)	M	Value = '3'
>Photometric Interpretation	(0028,0004)	M	Defined Term RGB used
>Rows	(0028,0010)	M	Value depends on scanning mode and configuration setup.
>Columns	(0028,0011)	M	Value depends on scanning mode and configuration setup.
>Pixel Aspect Ratio	(0028,0034)	MC	Not used
>Bits Allocated	(0028,0100)	M	Value always = 0008H
>Bits Stored	(0028,0101)	M	Value always = 0008H
>High Bit	(0028,0102)	M	Value always = 0007H
>Pixel Representation	(0028,0103)	M	Defined Value '0' - unsigned integer
>Pixel Data	(7FE0,0010)	M	
Planar Configuration	(0028, 0006)	M	0001H, color-by-plane, when Basic Color Image Sequence is set

**12.5.2.6 Printer Module**

This section defines the attributes that are used to monitor the status of the printer. The attributes described in Table 12.5.2-6 apply when the DIMSE Service N-GET is used.

**TABLE 12.5.2-6 PRINTER MODULE ATTRIBUTES**

Attribute Name	Tag	USAG E (SCU)	Attribute Description
Printer Status	(2110,0010)	U	Used to check the status of the printer before a print operation is started.  If the status is different from 0x0, Success the print operation is aborted, a message is displayed and the print files reside in the print buffer.
Printer Status Info	(2110,0020)	U	If return status is "FAILURE" an error message is displayed, and the print files resides in the print buffer.
Printer Name	(2110,0030)	U	Requested, but not used
Manufacturer	(0008,0070)	U	Requested, but not used
Manufacturer Model Name	(0008,1090)	U	Requested, but not used
Device Serial Number	(0018,1000)	U	Requested, but not used
Software Versions	(0018,1020)	U	Requested, but not used
Date Last Calibration	(0018,1200)	U	Requested, but not used
Last Calibration	(0018,1201)	U	Requested, but not used

## **13. STUDY ROOT QUERY/RETRIEVE INFORMATION MODEL DEFINITION**

### **13.1 INTRODUCTION**

This section specifies the use of the DICOM Study Root Query/Retrieve Model used to organize data and against which a Query/Retrieve will be performed. The contents of this section are:

13.2 - Information Model Description

13.3 - Information Model Entity-Relationship Model

13.4 - Information Model Keys

### **13.2 STUDY ROOT INFORMATION MODEL DESCRIPTION**

This section defines the implementation of Study Root Query/Retrieve Information Model.

### **13.3 STUDY ROOT INFORMATION MODEL ENTITY-RELATIONSHIP MODEL**

The Entity-Relationship diagram for the Study Root Information Model schema is shown in Illustration 13.3-1. In this figure, the following diagrammatic convention is established to represent the information organization :

- each entity is represented by a rectangular box
- each relationship is represented by a diamond shaped box.
- the fact that a relationship exists between two entities is depicted by lines connecting the corresponding entity boxes to the relationship boxes.

The relationships are fully defined with the maximum number of possible entities in the relationship shown. In other words, the relationship between Series and Image can have up to n Images per Series.

**ILLUSTRATION 13.3-1**  
**STUDY ROOT QUERY/RETRIEVE INFORMATION MODEL E/R DIAGRAM**

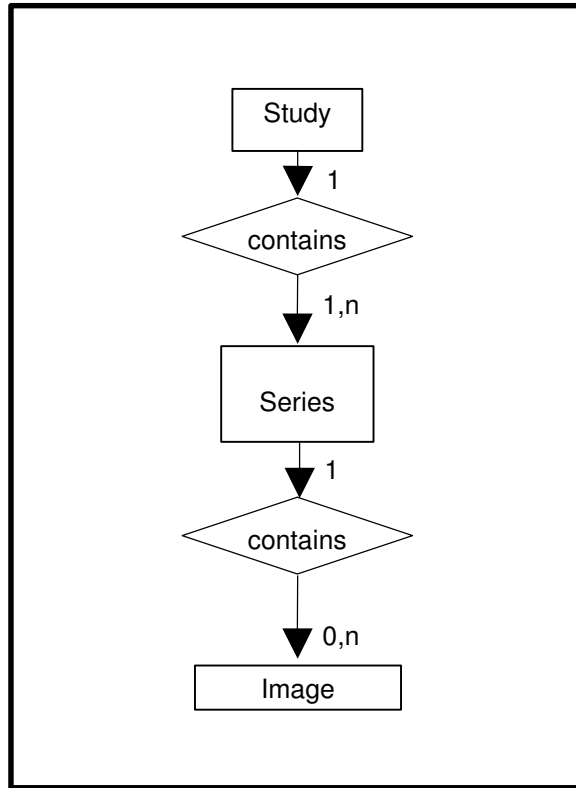

**13.3.1 Entity Descriptions**

Please refer to DICOM Standard PS 3.4 (Service Class Specifications) for a description of each of the levels contained within the Study Root Query/Retrieve Information Model.

**13.3.2 Vivid7 Mapping of DICOM entities**

**TABLE 13.3-1**  
**MAPPING OF DICOM ENTITIES TO VIVID7 ENTITIES**

DICOM	Vivid7 Entity
Study	Exam
Series	Exam
Image	Image

**13.4 INFORMATION MODEL KEYS**

Please refer to DICOM Standard PS 3.4 (Service Class Specifications) for a description of each of the levels contained within the Study Root Query/Retrieve Information Model.

The following Level descriptions are included to specify what data elements are supported and what type of matching can be applied. It should be noted that they are the same ones as defined in the DICOM Standard PS 3.4 (Service Class Specifications).

### 13.4.1 Supported Matching

Following are the types of matching that can be request by the implementation :

- Single Value matching
- List of UID matching
- Universal Matching
- Wild Card Matching
- Range of date, Range of Time
- Sequence Matching

Fields with “Filtering is supported” in the Matching column can be controlled from the Search screen. This means that the user can filter the downloaded C-FIND result, to view a limited set of the result.

All non-required matching fields can be configured in Config screen to be either enabled, enabled with a constant value or disabled. The constant value will be used as entered by user.

### 13.4.2 Study Level

This section defines the keys at the Study Level of the Study Root Query/Retrieve Information Model that are supported by this implementation.

**TABLE 13.4-2**  
**STUDY LEVEL ATTRIBUTES FOR THE STUDY ROOT**  
**QUERY/RETRIEVE INFORMATION MODEL**

Attribute Name	Tag	Type	Attribute Description
Study Date	(0008,0020)	R	Matching is supported. Filtering is supported.
Study Time	(0008,0030)	R	Matching is supported.
Accession Number	(0008,0050)	R	Matching is supported. Filtering is supported.
Patient's Name	(0010,0010)	R	Matching is supported. Filtering is supported.
Patient ID	(0010,0020)	U	Matching is supported. Filtering is supported.
Study ID	(0020,0010)	R	Matching is supported. Filtering is supported.
Study Instance UID	(0020,000D)	U	Matching is supported.
Modalities in Study	(0008,0061)	O	Matching is supported.
Referring Physician's Name	(0008,0090)	O	Matching is supported.
Study Description	(0008,1030)	O	Matching is supported.
Procedure Code Sequence	(0008,1032)	O	Matching is supported.
>Include 'Code Sequence Macro'			
Name of Physician(s) Reading Study	(0008,1060)	O	Matching is supported.
Admitting Diagnoses Description	(0008,1080)	O	Matching is supported.
Referenced Study Sequence	(0008,1110)	O	Matching is supported.
>Referenced SOP Class UID	(0008,1150)	O	Matching is supported.
>Referenced SOP Instance UID	(0008,1155)	O	Matching is supported.

Referenced Patient Sequence	(0008,1120)	O	Matching is supported.
>Referenced SOP Class UID	(0008,1150)	O	Matching is supported.
>Referenced SOP Instance UID	(0008,1155)	O	Matching is supported.
Patient's Birth Date	(0010,0030)	O	Matching is supported. Filtering is supported.
Patient's Birth Time	(0010,0032)	O	Matching is supported.
Patient's Sex	(0010,0040)	O	Matching is supported. Filtering is supported.
Other Patient IDs	(0010,1000)	O	Matching is supported.
Other Patient Names	(0010,1001)	O	Matching is supported.
Patient's Age	(0010,1010)	O	Matching is supported.
Patient's Size	(0010,1020)	O	Matching is supported.
Patient's Weight	(0010,1030)	O	Matching is supported.
Ethnic Group	(0010,2160)	O	Matching is supported.
Occupation	(0010,2180)	O	Matching is supported.
Additional Patient History	(0010,21B0)	O	Matching is supported.
Patient Comments	(0010,4000)	O	Matching is supported.
Other Study Numbers	(0020,1070)	O	Matching is supported.
Number of Patient Related Studies	(0020,1200)	O	Matching is supported.
Number of Patient Related Series	(0020,1202)	O	Matching is supported.
Number of Patient Related Instances	(0020,1204)	O	Matching is supported.
Number of Study Related Series	(0020,1206)	O	Matching is supported.
Number of Study Related Instances	(0020,1208)	O	Matching is supported.
Interpretation Author	(4008,010C)	O	Matching is supported.

TABLE 13.4-3

## Q/R STUDY LEVEL AND LOCATION FOR RETRIEVE ATTRIBUTES

Attribute Name	Tag	Type	Note
Query Retrieve Level	(0008,0052)	-	Value = STUDY

TABLE 13.4-4

## Q/R SPECIFIC CHARACTER SET ATTRIBUTES

Attribute Name	Tag	Type	Note
Specific Character Set	(0008,0005)	-	Set to "ISO_IR 100" if extended characters are used in query. ISO_IR 100 is supported in responses.

## 13.4.3 Series Level

This section defines the keys at the Series Level of the Study Root Query/Retrieve Information Model that are supported by this implementation.

**TABLE 13.4-5**  
**SERIES LEVEL ATTRIBUTES FOR THE STUDY ROOT**  
**QUERY/RETRIEVE INFORMATION MODEL**

Attribute Name	Tag	Type	Attribute Description
Modality	(0008,0060)	R	Matching is supported.
Series Number	(0020,0011)	R	Matching is supported.
Series Instance UID	(0020,000E)	U	Matching is supported.
Number of Series Related Instances	(0020,1209)	O	Matching is supported.
Series Date	(0008,0021)	O	Matching is supported.
Series Time	(0008,0031)	O	Matching is supported.
Performing Physicians' Name	(0008,1050)	O	Matching is supported.
Protocol Name	(0018,1030)	O	Matching is supported.
Series Description	(0008,103E)	O	Matching is supported.
Operator's Name	(0008,1070)	O	Matching is supported.
Institutional Department Name	(0008,1040)	O	Matching is supported.
Software Versions	(0018,1020)	O	Matching is supported.
Performed Procedure Step Start Date	(0040,0244)	O	Matching is supported.
Performed Procedure Step Start Time	(0040,0245)	O	Matching is supported.
Request Attributes Sequence	(0040,0275)	O	Matching is supported.

**TABLE 13.4-6**  
**Q/R SERIES LEVEL AND LOCATION FOR RETRIEVE ATTRIBUTES**

Attribute Name	Tag	Type	Note
Query Retrieve Level	(0008,0052)	-	Value = SERIES

**TABLE 13.4-7**  
**Q/R SPECIFIC CHARACTER SET ATTRIBUTES**

Attribute Name	Tag	Type	Note
Specific Character Set	(0008,0005)	-	Set to "ISO_IR 100" if extended characters are used in query. ISO_IR 100 is supported in responses.

#### 13.4.4 Image Level

This section defines the keys at the Image Level of the Study Root Query/Retrieve Information Model that are supported by this implementation.

**TABLE 13.4-8**  
**IMAGE LEVEL ATTRIBUTES FOR THE STUDY ROOT**  
**QUERY/RETRIEVE INFORMATION MODEL**

Attribute Name	Tag	Type	Attribute Description
Instance Number	(0020,0013)	R	Matching is supported.



SOP Instance UID	(0008,0018)	U	Matching is supported.
Contrast/Bolus Agent	(0018,0010)	O	Matching is supported.

TABLE 13.4-9

## Q/R IMAGE LEVEL AND LOCATION FOR RETRIEVE ATTRIBUTES

Attribute Name	Tag	Type	Note
Query Retrieve Level	(0008,0052)	-	Value = IMAGE

TABLE 13.4-10

## Q/R SPECIFIC CHARACTER SET ATTRIBUTES

Attribute Name	Tag	Type	Note
Specific Character Set	(0008,0005)	-	Set to "ISO_IR 100" if extended characters are used in query. ISO_IR 100 is supported in responses.

## 13.5 PRIVATE DATA DICTIONARY

No private data dictionary is defined.

## 14. SR MAPPING TABLE

This table maps the product's internal parameter ids (and in some cases the mode) to (anatomy) Section, Base Measurement and Modifiers in DICOM SR. The parameters are grouped by Section.

Please note that the rightmost column does not contain all possible modifiers. Only the necessary modifiers for the GEU parameter name are listed. Specifically, not all modes are listed.

### Section Left Ventricle

Name of GEU parameter	Base Measurement Concept Name	Concept or Acquisition Context Modifier
CO(A-L)	(F-32100, SRT, "Cardiac Output")	(G-C0E3, SRT, "Finding Site") = (T-32600, SRT, "Left Ventricle") (G-C036, SRT, "Measurement Method") = (125205, DCM, "Area-Length Single Plane")
CO(A-L A4C)/AutoHR	(F-32100, SRT, "Cardiac Output")	(G-C0E3, SRT, "Finding Site") = (T-32600, SRT, "Left Ventricle") (111031, DCM, "Image View") = (G-A19C, SRT, "Apical four chamber") (G-C036, SRT, "Measurement Method") = (125205, DCM, "Area-Length Single Plane")
CI(A-L A4C)/AutoHR	(F-32110, SRT, "Cardiac Index")	(G-C0E3, SRT, "Finding Site") = (T-32600, SRT, "Left Ventricle") (111031, DCM, "Image View") = (G-A19C, SRT, "Apical four chamber") (G-C036, SRT, "Measurement Method") = (125205, DCM, "Area-Length Single Plane")
CO(MOD A4C)/AutoHR	(F-32100, SRT, "Cardiac Output")	(G-C0E3, SRT, "Finding Site") = (T-32600, SRT, "Left Ventricle") (111031, DCM, "Image View") = (G-A19C, SRT, "Apical four chamber") (G-C036, SRT, "Measurement Method") = (125208, DCM, "Method of Disks, Single Plane")
CI(MOD A4C)/AutoHR	(F-32110, SRT, "Cardiac Index")	(G-C0E3, SRT, "Finding Site") = (T-32600, SRT, "Left Ventricle") (111031, DCM, "Image View") = (G-A19C, SRT, "Apical four chamber") (G-C036, SRT, "Measurement Method") = (125208, DCM, "Method of Disks, Single Plane")

<b>CO(A-L A2C)/AutoHR</b>	<b>(F-32100, SRT, "Cardiac Output")</b>	<b>(G-C0E3, SRT, "Finding Site") = (T-32600, SRT, "Left Ventricle") (111031, DCM, "Image View") = (G-A19B, SRT, "Apical two chamber") (G-C036, SRT, "Measurement Method") = (125205, DCM, "Area-Length Single Plane")</b>
<b>CI(A-L A2C)/AutoHR</b>	<b>(F-32110, SRT, "Cardiac Index")</b>	<b>(G-C0E3, SRT, "Finding Site") = (T-32600, SRT, "Left Ventricle") (111031, DCM, "Image View") = (G-A19B, SRT, "Apical two chamber") (G-C036, SRT, "Measurement Method") = (125205, DCM, "Area-Length Single Plane")</b>
<b>CO(MOD A2C)/AutoHR</b>	<b>(F-32100, SRT, "Cardiac Output")</b>	<b>(G-C0E3, SRT, "Finding Site") = (T-32600, SRT, "Left Ventricle") (111031, DCM, "Image View") = (G-A19B, SRT, "Apical two chamber") (G-C036, SRT, "Measurement Method") = (125208, DCM, "Method of Disks, Single Plane")</b>
<b>CI(MOD A2C)/AutoHR</b>	<b>(F-32110, SRT, "Cardiac Index")</b>	<b>(G-C0E3, SRT, "Finding Site") = (T-32600, SRT, "Left Ventricle") (111031, DCM, "Image View") = (G-A19B, SRT, "Apical two chamber") (G-C036, SRT, "Measurement Method") = (125208, DCM, "Method of Disks, Single Plane")</b>
<b>CO(A-L LAX)/AutoHR</b>	<b>(F-32100, SRT, "Cardiac Output")</b>	<b>(G-C0E3, SRT, "Finding Site") = (T-32600, SRT, "Left Ventricle") (111031, DCM, "Image View") = (G-0395, SRT, "Apical long axis") (G-C036, SRT, "Measurement Method") = (125205, DCM, "Area-Length Single Plane")</b>
<b>CI(A-L LAX)/AutoHR</b>	<b>(F-32110, SRT, "Cardiac Index")</b>	<b>(G-C0E3, SRT, "Finding Site") = (T-32600, SRT, "Left Ventricle") (111031, DCM, "Image View") = (G-0395, SRT, "Apical long axis") (G-C036, SRT, "Measurement Method") = (125205, DCM, "Area-Length Single Plane")</b>
<b>CO(MOD LAX)/AutoHR</b>	<b>(F-32100, SRT, "Cardiac Output")</b>	<b>(G-C0E3, SRT, "Finding Site") = (T-32600, SRT, "Left Ventricle") (111031, DCM, "Image View") = (G-0395, SRT, "Apical long axis") (G-C036, SRT, "Measurement Method") = (125208, DCM, "Method of Disks, Single Plane")</b>
<b>CI(MOD LAX)/AutoHR</b>	<b>(F-32110, SRT,</b>	<b>(G-C0E3, SRT, "Finding Site") = (T-32600, SRT,</b>

	"Cardiac Index")	"Left Ventricle") (111031, DCM, "Image View") = (G-0395, SRT, "Apical long axis") (G-C036, SRT, "Measurement Method") = (125208, DCM, "Method of Disks, Single Plane")
LVEDV(MOD BP)_03	(18026-5, LN, "Left Ventricular End Diastolic Volume")	(G-C036, SRT, "Measurement Method") = (125207, DCM, "Method of Disks, Biplane")
LVESV(MOD BP)_03	(18148-7, LN, "Left Ventricular End Systolic Volume")	(G-C036, SRT, "Measurement Method") = (125207, DCM, "Method of Disks, Biplane")
EF(Biplane)_03	(18043-0, LN, "Left Ventricular Ejection Fraction")	(G-C036, SRT, "Measurement Method") = (125207, DCM, "Method of Disks, Biplane")
SV(Biplane)_03	(F-32120, SRT, "Stroke Volume")	(G-C036, SRT, "Measurement Method") = (125207, DCM, "Method of Disks, Biplane")
SI(Biplane)_03	(F-00078, SRT, "Stroke Index")	(G-C036, SRT, "Measurement Method") = (125207, DCM, "Method of Disks, Biplane")
CO(Biplane)_03	(F-32100, SRT, "Cardiac Output")	(G-C036, SRT, "Measurement Method") = (125207, DCM, "Method of Disks, Biplane")
CI(Biplane)_03	(F-32110, SRT, "Cardiac Index")	(G-C036, SRT, "Measurement Method") = (125207, DCM, "Method of Disks, Biplane")
2D/IVSd	(18154-5, LN, "Interventricular Septum Diastolic Thickness")	(G-0373, SRT, "Image Mode") = (G-03A2, SRT, "2D mode") or (R-409E2, SRT, "Doppler Color Flow") depending on scan mode
ECG/HeartRate/Auto	(8867-4, LN, "Heart rate")	
2D/LVIDd	(29436-3, LN, "Left Ventricle Internal End Diastolic Dimension")	(G-0373, SRT, "Image Mode") = (G-03A2, SRT, "2D mode") or (R-409E2, SRT, "Doppler Color Flow") depending on scan mode
2D/LVIDs	(29438-9, LN, "Left Ventricle Internal Systolic Dimension")	(G-0373, SRT, "Image Mode") = (G-03A2, SRT, "2D mode") or (R-409E2, SRT, "Doppler Color Flow") depending on scan mode
2D/LVPWd	(18152-9, LN, "Left Ventricle Posterior Wall Diastolic	(G-0373, SRT, "Image Mode") = (G-03A2, SRT, "2D mode") or (R-409E2, SRT, "Doppler Color Flow")

	Thickness")	depending on scan mode
2D/LVPWs	(18156-0, LN, "Left Ventricle Posterior Wall Systolic Thickness")	(G-0373, SRT, "Image Mode") = (G-03A2, SRT, "2D mode") or (R-409E2, SRT, "Doppler Color Flow") depending on scan mode
2D/IVSs	(18158-6, LN, "Interventricular Septum Systolic Thickness")	(G-0373, SRT, "Image Mode") = (G-03A2, SRT, "2D mode") or (R-409E2, SRT, "Doppler Color Flow") depending on scan mode
2D/LVOT Diam	(G-038F, SRT, "Cardiovascular Orifice Diameter")	(G-C0E3, SRT, "Finding Site") = (T-32650, SRT, "Left Ventricle Outflow Tract") (G-0373, SRT, "Image Mode") = (G-03A2, SRT, "2D mode") or (R-409E2, SRT, "Doppler Color Flow") depending on scan mode
2D/EDV(Teich)	(18026-5, LN, "Left Ventricular End Diastolic Volume")	(G-0373, SRT, "Image Mode") = (G-03A2, SRT, "2D mode") or (R-409E2, SRT, "Doppler Color Flow") depending on scan mode (G-C036, SRT, "Measurement Method") = (125209, DCM, "Teichholz")
2D/ESV(Teich)	(18148-7, LN, "Left Ventricular End Systolic Volume")	(G-0373, SRT, "Image Mode") = (G-03A2, SRT, "2D mode") or (R-409E2, SRT, "Doppler Color Flow") depending on scan mode (G-C036, SRT, "Measurement Method") = (125209, DCM, "Teichholz")
2D/EF(Teich)	(18043-0, LN, "Left Ventricular Ejection Fraction")	(G-0373, SRT, "Image Mode") = (G-03A2, SRT, "2D mode") or (R-409E2, SRT, "Doppler Color Flow") depending on scan mode (G-C036, SRT, "Measurement Method") = (125209, DCM, "Teichholz")
2D/EDV(Cube)	(18026-5, LN, "Left Ventricular End Diastolic Volume")	(G-0373, SRT, "Image Mode") = (G-03A2, SRT, "2D mode") or (R-409E2, SRT, "Doppler Color Flow") depending on scan mode (G-C036, SRT, "Measurement Method") = (125206, DCM, "Cube Method")
2D/ESV(Cube)	(18148-7, LN, "Left Ventricular End Systolic Volume")	(G-0373, SRT, "Image Mode") = (G-03A2, SRT, "2D mode") or (R-409E2, SRT, "Doppler Color Flow") depending on scan mode (G-C036, SRT, "Measurement Method") = (125206, DCM, "Cube Method")
2D/EF(Cube)	(18043-0, LN, "Left Ventricular Ejection Fraction")	(G-0373, SRT, "Image Mode") = (G-03A2, SRT, "2D mode") or (R-409E2, SRT, "Doppler Color Flow")

	Fraction")	depending on scan mode (G-C036, SRT, "Measurement Method") = (125206, DCM, "Cube Method")
2D/%FS	(18051-3, LN, "Left Ventricular Fractional Shortening")	(G-0373, SRT, "Image Mode") = (G-03A2, SRT, "2D mode") or (R-409E2, SRT, "Doppler Color Flow") depending on scan mode
2D/%IVS Thck	(18054-7, LN, "Interventricular Septum % Thickening")	(G-0373, SRT, "Image Mode") = (G-03A2, SRT, "2D mode") or (R-409E2, SRT, "Doppler Color Flow") depending on scan mode
2D/%LVPW Thck	(18053-9, LN, "Left Ventricle Posterior Wall % Thickening")	(G-0373, SRT, "Image Mode") = (G-03A2, SRT, "2D mode") or (R-409E2, SRT, "Doppler Color Flow") depending on scan mode
2D/SV(Teich)	(F-32120, SRT, "Stroke Volume")	(G-C0E3, SRT, "Finding Site") = (T-32600, SRT, "Left Ventricle") (G-0373, SRT, "Image Mode") = (G-03A2, SRT, "2D mode") or (R-409E2, SRT, "Doppler Color Flow") depending on scan mode (G-C036, SRT, "Measurement Method") = (125209, DCM, "Teichholz")
2D/SI(Teich)	(F-00078, SRT, "Stroke Index")	(G-C0E3, SRT, "Finding Site") = (T-32600, SRT, "Left Ventricle") (G-0373, SRT, "Image Mode") = (G-03A2, SRT, "2D mode") or (R-409E2, SRT, "Doppler Color Flow") depending on scan mode (G-C036, SRT, "Measurement Method") = (125209, DCM, "Teichholz")
2D/CO(Teich)	(F-32100, SRT, "Cardiac Output")	(G-C0E3, SRT, "Finding Site") = (T-32600, SRT, "Left Ventricle") (G-0373, SRT, "Image Mode") = (G-03A2, SRT, "2D mode") or (R-409E2, SRT, "Doppler Color Flow") depending on scan mode (G-C036, SRT, "Measurement Method") = (125209, DCM, "Teichholz")
2D/CI(Teich)	(F-32110, SRT, "Cardiac Index")	(G-C0E3, SRT, "Finding Site") = (T-32600, SRT, "Left Ventricle") (G-0373, SRT, "Image Mode") = (G-03A2, SRT, "2D mode") or (R-409E2, SRT, "Doppler Color Flow") depending on scan mode (G-C036, SRT, "Measurement Method") = (125209, DCM, "Teichholz")
2D/SV(Cube)	(F-32120, SRT,	(G-C0E3, SRT, "Finding Site") = (T-32600, SRT,

	"Stroke Volume")	"Left Ventricle") (G-0373, SRT, "Image Mode") = (G-03A2, SRT, "2D mode") or (R-409E2, SRT, "Doppler Color Flow") depending on scan mode (G-C036, SRT, "Measurement Method") = (125206, DCM, "Cube Method")
2D/SI(Cube)	(F-00078, SRT, "Stroke Index")	(G-C0E3, SRT, "Finding Site") = (T-32600, SRT, "Left Ventricle") (G-0373, SRT, "Image Mode") = (G-03A2, SRT, "2D mode") or (R-409E2, SRT, "Doppler Color Flow") depending on scan mode (G-C036, SRT, "Measurement Method") = (125206, DCM, "Cube Method")
2D/CO(Cube)	(F-32100, SRT, "Cardiac Output")	(G-C0E3, SRT, "Finding Site") = (T-32600, SRT, "Left Ventricle") (G-0373, SRT, "Image Mode") = (G-03A2, SRT, "2D mode") or (R-409E2, SRT, "Doppler Color Flow") depending on scan mode (G-C036, SRT, "Measurement Method") = (125206, DCM, "Cube Method")
2D/CI(Cube)	(F-32110, SRT, "Cardiac Index")	(G-C0E3, SRT, "Finding Site") = (T-32600, SRT, "Left Ventricle") (G-0373, SRT, "Image Mode") = (G-03A2, SRT, "2D mode") or (R-409E2, SRT, "Doppler Color Flow") depending on scan mode (G-C036, SRT, "Measurement Method") = (125206, DCM, "Cube Method")
2D/LVd Mass	(18087-7, LN, "Left Ventricle Mass")	(G-0373, SRT, "Image Mode") = (G-03A2, SRT, "2D mode") or (R-409E2, SRT, "Doppler Color Flow") depending on scan mode (R-4089A, SRT, "Cardiac Cycle Point") = (F-32010, SRT, "Diastole")
2D/LVs Mass	(18087-7, LN, "Left Ventricle Mass")	(G-0373, SRT, "Image Mode") = (G-03A2, SRT, "2D mode") or (R-409E2, SRT, "Doppler Color Flow") depending on scan mode (R-4089A, SRT, "Cardiac Cycle Point") = (F-32020, SRT, "Systole")
2D/LVd Mass/ASE	(18087-7, LN, "Left Ventricle Mass")	(G-0373, SRT, "Image Mode") = (G-03A2, SRT, "2D mode") or (R-409E2, SRT, "Doppler Color Flow") depending on scan mode (R-4089A, SRT, "Cardiac Cycle Point") = (F-32010, SRT, "Diastole") (G-C036, SRT, "Measurement Method") = (125221, DCM, "Left Ventricle Mass by M-mode")

2D/LVs Mass/ASE	(18087-7, LN, "Left Ventricle Mass")	(G-0373, SRT, "Image Mode") = (G-03A2, SRT, "2D mode") or (R-409E2, SRT, "Doppler Color Flow") depending on scan mode (R-4089A, SRT, "Cardiac Cycle Point") = (F-32020, SRT, "Systole") (G-C036, SRT, "Measurement Method") = (125221, DCM, "Left Ventricle Mass by M-mode")
2D/LVA diastole	(G-0375, SRT, "Left Ventricular Diastolic Area")	(G-0373, SRT, "Image Mode") = (G-03A2, SRT, "2D mode") or (R-409E2, SRT, "Doppler Color Flow") depending on scan mode
2D/LVA systole	(G-0374, SRT, "Left Ventricular Systolic Area")	(G-0373, SRT, "Image Mode") = (G-03A2, SRT, "2D mode") or (R-409E2, SRT, "Doppler Color Flow") depending on scan mode
2D/SAX/LVA diastole	(G-0375, SRT, "Left Ventricular Diastolic Area")	(G-0373, SRT, "Image Mode") = (G-03A2, SRT, "2D mode") or (R-409E2, SRT, "Doppler Color Flow") depending on scan mode (111031, DCM, "Image View") = (G-0397, SRT, "Parasternal short axis")
2D/SAX/LVA systole	(G-0374, SRT, "Left Ventricular Systolic Area")	(G-0373, SRT, "Image Mode") = (G-03A2, SRT, "2D mode") or (R-409E2, SRT, "Doppler Color Flow") depending on scan mode (111031, DCM, "Image View") = (G-0397, SRT, "Parasternal short axis")
2D/LVOT Area	(G-038E, SRT, "Cardiovascular Orifice Area")	(G-C0E3, SRT, "Finding Site") = (T-32650, SRT, "Left Ventricle Outflow Tract") (G-0373, SRT, "Image Mode") = (G-03A2, SRT, "2D mode") or (R-409E2, SRT, "Doppler Color Flow") depending on scan mode
2D/EDV(A-L)	(18026-5, LN, "Left Ventricular End Diastolic Volume")	(G-0373, SRT, "Image Mode") = (G-03A2, SRT, "2D mode") or (R-409E2, SRT, "Doppler Color Flow") depending on scan mode (G-C036, SRT, "Measurement Method") = (125205, DCM, "Area-Length Single Plane")
2D/EDV(MOD)	(18026-5, LN, "Left Ventricular End Diastolic Volume")	(G-0373, SRT, "Image Mode") = (G-03A2, SRT, "2D mode") or (R-409E2, SRT, "Doppler Color Flow") depending on scan mode (G-C036, SRT, "Measurement Method") = (125208, DCM, "Method of Disks, Single Plane")
2D/ESV(A-L)	(18148-7, LN, "Left Ventricular End Systolic Volume")	(G-0373, SRT, "Image Mode") = (G-03A2, SRT, "2D mode") or (R-409E2, SRT, "Doppler Color Flow") depending on scan mode (G-C036, SRT, "Measurement Method") = (125205, DCM, "Area-Length Single Plane")



		DCM, "Area-Length Single Plane")
2D/ESV(MOD)	(18148-7, LN, "Left Ventricular End Systolic Volume")	(G-0373, SRT, "Image Mode") = (G-03A2, SRT, "2D mode") or (R-409E2, SRT, "Doppler Color Flow") depending on scan mode (G-C036, SRT, "Measurement Method") = (125208, DCM, "Method of Disks, Single Plane")
2D/EF(A-L)	(18043-0, LN, "Left Ventricular Ejection Fraction")	(G-0373, SRT, "Image Mode") = (G-03A2, SRT, "2D mode") or (R-409E2, SRT, "Doppler Color Flow") depending on scan mode (G-C036, SRT, "Measurement Method") = (125205, DCM, "Area-Length Single Plane")
2D/SV(A-L)	(F-32120, SRT, "Stroke Volume")	(G-C0E3, SRT, "Finding Site") = (T-32600, SRT, "Left Ventricle") (G-0373, SRT, "Image Mode") = (G-03A2, SRT, "2D mode") or (R-409E2, SRT, "Doppler Color Flow") depending on scan mode (G-C036, SRT, "Measurement Method") = (125205, DCM, "Area-Length Single Plane")
2D/SI(A-L)	(F-00078, SRT, "Stroke Index")	(G-C0E3, SRT, "Finding Site") = (T-32600, SRT, "Left Ventricle") (G-0373, SRT, "Image Mode") = (G-03A2, SRT, "2D mode") or (R-409E2, SRT, "Doppler Color Flow") depending on scan mode (G-C036, SRT, "Measurement Method") = (125205, DCM, "Area-Length Single Plane")
2D/EF(MOD)	(18043-0, LN, "Left Ventricular Ejection Fraction")	(G-0373, SRT, "Image Mode") = (G-03A2, SRT, "2D mode") or (R-409E2, SRT, "Doppler Color Flow") depending on scan mode (G-C036, SRT, "Measurement Method") = (125208, DCM, "Method of Disks, Single Plane")
2D/SV(MOD)	(F-32120, SRT, "Stroke Volume")	(G-C0E3, SRT, "Finding Site") = (T-32600, SRT, "Left Ventricle") (G-0373, SRT, "Image Mode") = (G-03A2, SRT, "2D mode") or (R-409E2, SRT, "Doppler Color Flow") depending on scan mode (G-C036, SRT, "Measurement Method") = (125208, DCM, "Method of Disks, Single Plane")
2D/SI(MOD)	(F-00078, SRT, "Stroke Index")	(G-C0E3, SRT, "Finding Site") = (T-32600, SRT, "Left Ventricle") (G-0373, SRT, "Image Mode") = (G-03A2, SRT, "2D mode") or (R-409E2, SRT, "Doppler Color Flow") depending on scan mode (G-C036, SRT, "Measurement Method") = (125208, DCM, "Method of Disks, Single Plane")

		DCM, "Method of Disks, Single Plane")
LVAAd(A4C)	(G-0375, SRT, "Left Ventricular Diastolic Area")	(111031, DCM, "Image View") = (G-A19C, SRT, "Apical four chamber")
LVEDV(A-L A4C)	(18026-5, LN, "Left Ventricular End Diastolic Volume")	(111031, DCM, "Image View") = (G-A19C, SRT, "Apical four chamber") (G-C036, SRT, "Measurement Method") = (125205, DCM, "Area-Length Single Plane")
LVEDV(MOD A4C)	(18026-5, LN, "Left Ventricular End Diastolic Volume")	(111031, DCM, "Image View") = (G-A19C, SRT, "Apical four chamber") (G-C036, SRT, "Measurement Method") = (125208, DCM, "Method of Disks, Single Plane")
LVAAs(A4C)	(G-0374, SRT, "Left Ventricular Systolic Area")	(111031, DCM, "Image View") = (G-A19C, SRT, "Apical four chamber")
LVESV(A-L A4C)	(18148-7, LN, "Left Ventricular End Systolic Volume")	(111031, DCM, "Image View") = (G-A19C, SRT, "Apical four chamber") (G-C036, SRT, "Measurement Method") = (125205, DCM, "Area-Length Single Plane")
LVESV(MOD A4C)	(18148-7, LN, "Left Ventricular End Systolic Volume")	(111031, DCM, "Image View") = (G-A19C, SRT, "Apical four chamber") (G-C036, SRT, "Measurement Method") = (125208, DCM, "Method of Disks, Single Plane")
EF(A-L A4C)	(18043-0, LN, "Left Ventricular Ejection Fraction")	(111031, DCM, "Image View") = (G-A19C, SRT, "Apical four chamber") (G-C036, SRT, "Measurement Method") = (125205, DCM, "Area-Length Single Plane")
SV(A-L A4C)	(F-32120, SRT, "Stroke Volume")	(G-C0E3, SRT, "Finding Site") = (T-32600, SRT, "Left Ventricle") (111031, DCM, "Image View") = (G-A19C, SRT, "Apical four chamber") (G-C036, SRT, "Measurement Method") = (125205, DCM, "Area-Length Single Plane")
SI(A-L A4C)	(F-00078, SRT, "Stroke Index")	(G-C0E3, SRT, "Finding Site") = (T-32600, SRT, "Left Ventricle") (111031, DCM, "Image View") = (G-A19C, SRT, "Apical four chamber") (G-C036, SRT, "Measurement Method") = (125205, DCM, "Area-Length Single Plane")

CO(A-L A4C)	(F-32100, SRT, "Cardiac Output")	(G-C0E3, SRT, "Finding Site") = (T-32600, SRT, "Left Ventricle") (111031, DCM, "Image View") = (G-A19C, SRT, "Apical four chamber") (G-C036, SRT, "Measurement Method") = (125205, DCM, "Area-Length Single Plane")
CI(A-L A4C)	(F-32110, SRT, "Cardiac Index")	(G-C0E3, SRT, "Finding Site") = (T-32600, SRT, "Left Ventricle") (111031, DCM, "Image View") = (G-A19C, SRT, "Apical four chamber") (G-C036, SRT, "Measurement Method") = (125205, DCM, "Area-Length Single Plane")
EF(MOD A4C)	(18043-0, LN, "Left Ventricular Ejection Fraction")	(111031, DCM, "Image View") = (G-A19C, SRT, "Apical four chamber") (G-C036, SRT, "Measurement Method") = (125208, DCM, "Method of Disks, Single Plane")
SV(MOD A4C)	(F-32120, SRT, "Stroke Volume")	(G-C0E3, SRT, "Finding Site") = (T-32600, SRT, "Left Ventricle") (111031, DCM, "Image View") = (G-A19C, SRT, "Apical four chamber") (G-C036, SRT, "Measurement Method") = (125208, DCM, "Method of Disks, Single Plane")
SI(MOD A4C)	(F-00078, SRT, "Stroke Index")	(G-C0E3, SRT, "Finding Site") = (T-32600, SRT, "Left Ventricle") (111031, DCM, "Image View") = (G-A19C, SRT, "Apical four chamber") (G-C036, SRT, "Measurement Method") = (125208, DCM, "Method of Disks, Single Plane")
CO(MOD A4C)	(F-32100, SRT, "Cardiac Output")	(G-C0E3, SRT, "Finding Site") = (T-32600, SRT, "Left Ventricle") (111031, DCM, "Image View") = (G-A19C, SRT, "Apical four chamber") (G-C036, SRT, "Measurement Method") = (125208, DCM, "Method of Disks, Single Plane")
CI(MOD A4C)	(F-32110, SRT, "Cardiac Index")	(G-C0E3, SRT, "Finding Site") = (T-32600, SRT, "Left Ventricle") (111031, DCM, "Image View") = (G-A19C, SRT, "Apical four chamber") (G-C036, SRT, "Measurement Method") = (125208, DCM, "Method of Disks, Single Plane")
LVAd(A2C)	(G-0375, SRT, "Left Ventricular Diastolic Area")	(111031, DCM, "Image View") = (G-A19B, SRT, "Apical two chamber")

LVEDV(A-L A2C)	(18026-5, LN, "Left Ventricular End Diastolic Volume")	(111031, DCM, "Image View") = (G-A19B, SRT, "Apical two chamber") (G-C036, SRT, "Measurement Method") = (125205, DCM, "Area-Length Single Plane")
LVEDV(MOD A2C)	(18026-5, LN, "Left Ventricular End Diastolic Volume")	(111031, DCM, "Image View") = (G-A19B, SRT, "Apical two chamber") (G-C036, SRT, "Measurement Method") = (125208, DCM, "Method of Disks, Single Plane")
LVA(A2C)	(G-0374, SRT, "Left Ventricular Systolic Area")	(111031, DCM, "Image View") = (G-A19B, SRT, "Apical two chamber")
LVESV(A-L A2C)	(18148-7, LN, "Left Ventricular End Systolic Volume")	(111031, DCM, "Image View") = (G-A19B, SRT, "Apical two chamber") (G-C036, SRT, "Measurement Method") = (125205, DCM, "Area-Length Single Plane")
LVESV(MOD A2C)	(18148-7, LN, "Left Ventricular End Systolic Volume")	(111031, DCM, "Image View") = (G-A19B, SRT, "Apical two chamber") (G-C036, SRT, "Measurement Method") = (125208, DCM, "Method of Disks, Single Plane")
EF(A-L A2C)	(18043-0, LN, "Left Ventricular Ejection Fraction")	(111031, DCM, "Image View") = (G-A19B, SRT, "Apical two chamber") (G-C036, SRT, "Measurement Method") = (125205, DCM, "Area-Length Single Plane")
SV(A-L A2C)	(F-32120, SRT, "Stroke Volume")	(G-C0E3, SRT, "Finding Site") = (T-32600, SRT, "Left Ventricle") (111031, DCM, "Image View") = (G-A19B, SRT, "Apical two chamber") (G-C036, SRT, "Measurement Method") = (125205, DCM, "Area-Length Single Plane")
SI(A-L A2C)	(F-00078, SRT, "Stroke Index")	(G-C0E3, SRT, "Finding Site") = (T-32600, SRT, "Left Ventricle") (111031, DCM, "Image View") = (G-A19B, SRT, "Apical two chamber") (G-C036, SRT, "Measurement Method") = (125205, DCM, "Area-Length Single Plane")
CO(A-L A2C)	(F-32100, SRT, "Cardiac Output")	(G-C0E3, SRT, "Finding Site") = (T-32600, SRT, "Left Ventricle") (111031, DCM, "Image View") = (G-A19B, SRT, "Apical two chamber") (G-C036, SRT, "Measurement Method") = (125205, DCM, "Area-Length Single Plane")

CI(A-L A2C)	(F-32110, SRT, "Cardiac Index")	(G-C0E3, SRT, "Finding Site") = (T-32600, SRT, "Left Ventricle") (111031, DCM, "Image View") = (G-A19B, SRT, "Apical two chamber") (G-C036, SRT, "Measurement Method") = (125205, DCM, "Area-Length Single Plane")
EF(MOD A2C)	(18043-0, LN, "Left Ventricular Ejection Fraction")	(111031, DCM, "Image View") = (G-A19B, SRT, "Apical two chamber") (G-C036, SRT, "Measurement Method") = (125208, DCM, "Method of Disks, Single Plane")
SV(MOD A2C)	(F-32120, SRT, "Stroke Volume")	(G-C0E3, SRT, "Finding Site") = (T-32600, SRT, "Left Ventricle") (111031, DCM, "Image View") = (G-A19B, SRT, "Apical two chamber") (G-C036, SRT, "Measurement Method") = (125208, DCM, "Method of Disks, Single Plane")
SI(MOD A2C)	(F-00078, SRT, "Stroke Index")	(G-C0E3, SRT, "Finding Site") = (T-32600, SRT, "Left Ventricle") (111031, DCM, "Image View") = (G-A19B, SRT, "Apical two chamber") (G-C036, SRT, "Measurement Method") = (125208, DCM, "Method of Disks, Single Plane")
CO(MOD A2C)	(F-32100, SRT, "Cardiac Output")	(G-C0E3, SRT, "Finding Site") = (T-32600, SRT, "Left Ventricle") (111031, DCM, "Image View") = (G-A19B, SRT, "Apical two chamber") (G-C036, SRT, "Measurement Method") = (125208, DCM, "Method of Disks, Single Plane")
CI(MOD A2C)	(F-32110, SRT, "Cardiac Index")	(G-C0E3, SRT, "Finding Site") = (T-32600, SRT, "Left Ventricle") (111031, DCM, "Image View") = (G-A19B, SRT, "Apical two chamber") (G-C036, SRT, "Measurement Method") = (125208, DCM, "Method of Disks, Single Plane")
LVAd(LAX)	(G-0375, SRT, "Left Ventricular Diastolic Area")	(111031, DCM, "Image View") = (G-0395, SRT, "Apical long axis")
LVEDV(A-L LAX)	(18026-5, LN, "Left Ventricular End Diastolic Volume")	(111031, DCM, "Image View") = (G-0395, SRT, "Apical long axis") (G-C036, SRT, "Measurement Method") = (125205, DCM, "Area-Length Single Plane")

LVEDV(MOD LAX)	(18026-5, LN, "Left Ventricular End Diastolic Volume")	(111031, DCM, "Image View") = (G-0395, SRT, "Apical long axis") (G-C036, SRT, "Measurement Method") = (125208, DCM, "Method of Disks, Single Plane")
LVA(LAX)	(G-0374, SRT, "Left Ventricular Systolic Area")	(111031, DCM, "Image View") = (G-0395, SRT, "Apical long axis")
LVESV(A-L LAX)	(18148-7, LN, "Left Ventricular End Systolic Volume")	(111031, DCM, "Image View") = (G-0395, SRT, "Apical long axis") (G-C036, SRT, "Measurement Method") = (125205, DCM, "Area-Length Single Plane")
LVESV(MOD LAX)	(18148-7, LN, "Left Ventricular End Systolic Volume")	(111031, DCM, "Image View") = (G-0395, SRT, "Apical long axis") (G-C036, SRT, "Measurement Method") = (125208, DCM, "Method of Disks, Single Plane")
EF(A-L LAX)	(18043-0, LN, "Left Ventricular Ejection Fraction")	(111031, DCM, "Image View") = (G-0395, SRT, "Apical long axis") (G-C036, SRT, "Measurement Method") = (125205, DCM, "Area-Length Single Plane")
SV(A-L LAX)	(F-32120, SRT, "Stroke Volume")	(G-C0E3, SRT, "Finding Site") = (T-32600, SRT, "Left Ventricle") (111031, DCM, "Image View") = (G-0395, SRT, "Apical long axis") (G-C036, SRT, "Measurement Method") = (125205, DCM, "Area-Length Single Plane")
SI(A-L LAX)	(F-00078, SRT, "Stroke Index")	(G-C0E3, SRT, "Finding Site") = (T-32600, SRT, "Left Ventricle") (111031, DCM, "Image View") = (G-0395, SRT, "Apical long axis") (G-C036, SRT, "Measurement Method") = (125205, DCM, "Area-Length Single Plane")
CO(A-L LAX)	(F-32100, SRT, "Cardiac Output")	(G-C0E3, SRT, "Finding Site") = (T-32600, SRT, "Left Ventricle") (111031, DCM, "Image View") = (G-0395, SRT, "Apical long axis") (G-C036, SRT, "Measurement Method") = (125205, DCM, "Area-Length Single Plane")
CI(A-L LAX)	(F-32110, SRT, "Cardiac Index")	(G-C0E3, SRT, "Finding Site") = (T-32600, SRT, "Left Ventricle") (111031, DCM, "Image View") = (G-0395, SRT, "Apical long axis") (G-C036, SRT, "Measurement Method") = (125205, DCM, "Area-Length Single Plane")

		DCM, "Area-Length Single Plane")
EF(MOD LAX)	(18043-0, LN, "Left Ventricular Ejection Fraction")	(111031, DCM, "Image View") = (G-0395, SRT, "Apical long axis") (G-C036, SRT, "Measurement Method") = (125208, DCM, "Method of Disks, Single Plane")
SV(MOD LAX)	(F-32120, SRT, "Stroke Volume")	(G-C0E3, SRT, "Finding Site") = (T-32600, SRT, "Left Ventricle") (111031, DCM, "Image View") = (G-0395, SRT, "Apical long axis") (G-C036, SRT, "Measurement Method") = (125208, DCM, "Method of Disks, Single Plane")
SI(MOD LAX)	(F-00078, SRT, "Stroke Index")	(G-C0E3, SRT, "Finding Site") = (T-32600, SRT, "Left Ventricle") (111031, DCM, "Image View") = (G-0395, SRT, "Apical long axis") (G-C036, SRT, "Measurement Method") = (125208, DCM, "Method of Disks, Single Plane")
CO(MOD LAX)	(F-32100, SRT, "Cardiac Output")	(G-C0E3, SRT, "Finding Site") = (T-32600, SRT, "Left Ventricle") (111031, DCM, "Image View") = (G-0395, SRT, "Apical long axis") (G-C036, SRT, "Measurement Method") = (125208, DCM, "Method of Disks, Single Plane")
CI(MOD LAX)	(F-32110, SRT, "Cardiac Index")	(G-C0E3, SRT, "Finding Site") = (T-32600, SRT, "Left Ventricle") (111031, DCM, "Image View") = (G-0395, SRT, "Apical long axis") (G-C036, SRT, "Measurement Method") = (125208, DCM, "Method of Disks, Single Plane")
LVEDV(MOD BP)	(18026-5, LN, "Left Ventricular End Diastolic Volume")	(G-C036, SRT, "Measurement Method") = (125207, DCM, "Method of Disks, Biplane")
LVESV(MOD BP)	(18148-7, LN, "Left Ventricular End Systolic Volume")	(G-C036, SRT, "Measurement Method") = (125207, DCM, "Method of Disks, Biplane")
EF(Biplane)	(18043-0, LN, "Left Ventricular Ejection Fraction")	(G-C036, SRT, "Measurement Method") = (125207, DCM, "Method of Disks, Biplane")
SV(Biplane)	(F-32120, SRT, "Stroke Volume")	(G-C036, SRT, "Measurement Method") = (125207, DCM, "Method of Disks, Biplane")

SI(Biplane)	(F-00078, SRT, "Stroke Index")	(G-C036, SRT, "Measurement Method") = (125207, DCM, "Method of Disks, Biplane")
CO(Biplane)	(F-32100, SRT, "Cardiac Output")	(G-C036, SRT, "Measurement Method") = (125207, DCM, "Method of Disks, Biplane")
CI(Biplane)	(F-32110, SRT, "Cardiac Index")	(G-C036, SRT, "Measurement Method") = (125207, DCM, "Method of Disks, Biplane")
LVLd(apical)	(18077-8, LN, "Left Ventricle diastolic major axis")	
LVLs(apical)	(18076-0, LN, "Left Ventricle systolic major axis")	
LVAd(sax MV)	(G-0375, SRT, "Left Ventricular Diastolic Area")	(111031, DCM, "Image View") = (G-039A, SRT, "Parasternal short axis at the Mitral Valve level")
LVAs(sax MV)	(G-0374, SRT, "Left Ventricular Systolic Area")	(111031, DCM, "Image View") = (G-039A, SRT, "Parasternal short axis at the Mitral Valve level")
LVAd(sax PM)	(G-0375, SRT, "Left Ventricular Diastolic Area")	(111031, DCM, "Image View") = (G-039B, SRT, "Parasternal short axis at the Papillary Muscle level")
LVAs(sax PM)	(G-0374, SRT, "Left Ventricular Systolic Area")	(111031, DCM, "Image View") = (G-039B, SRT, "Parasternal short axis at the Papillary Muscle level")
LVAd(sax)	(G-0375, SRT, "Left Ventricular Diastolic Area")	(111031, DCM, "Image View") = (G-0397, SRT, "Parasternal short axis")
LVAs(sax)	(G-0374, SRT, "Left Ventricular Systolic Area")	(111031, DCM, "Image View") = (G-0397, SRT, "Parasternal short axis")
EDV(mod sim)	(18026-5, LN, "Left Ventricular End Diastolic Volume")	
ESV(mod sim)	(18148-7, LN, "Left Ventricular End Systolic Volume")	



<b>EF(mod sim)</b>	(18043-0, LN, "Left Ventricular Ejection Fraction")	
<b>SV(mod sim)</b>	(F-32120, SRT, "Stroke Volume")	(G-C0E3, SRT, "Finding Site") = (T-32600, SRT, "Left Ventricle")
<b>SI(mod sim)</b>	(F-00078, SRT, "Stroke Index")	(G-C0E3, SRT, "Finding Site") = (T-32600, SRT, "Left Ventricle")
<b>CO(mod sim)</b>	(F-32100, SRT, "Cardiac Output")	(G-C0E3, SRT, "Finding Site") = (T-32600, SRT, "Left Ventricle")
<b>CI(mod sim)</b>	(F-32110, SRT, "Cardiac Index")	(G-C0E3, SRT, "Finding Site") = (T-32600, SRT, "Left Ventricle")
<b>EDV(bullet)</b>	(18026-5, LN, "Left Ventricular End Diastolic Volume")	
<b>ESV(bullet)</b>	(18148-7, LN, "Left Ventricular End Systolic Volume")	
<b>EF(bullet)</b>	(18043-0, LN, "Left Ventricular Ejection Fraction")	
<b>SV(bullet)</b>	(F-32120, SRT, "Stroke Volume")	(G-C0E3, SRT, "Finding Site") = (T-32600, SRT, "Left Ventricle")
<b>SI(bullet)</b>	(F-00078, SRT, "Stroke Index")	(G-C0E3, SRT, "Finding Site") = (T-32600, SRT, "Left Ventricle")
<b>CO(bullet)</b>	(F-32100, SRT, "Cardiac Output")	(G-C0E3, SRT, "Finding Site") = (T-32600, SRT, "Left Ventricle")
<b>CI(bullet)</b>	(F-32110, SRT, "Cardiac Index")	(G-C0E3, SRT, "Finding Site") = (T-32600, SRT, "Left Ventricle")
<b>EDV(bp el)</b>	(18026-5, LN, "Left Ventricular End Diastolic Volume")	(G-C036, SRT, "Measurement Method") = (125211, DCM, "Biplane Ellipse")
<b>ESV(bp el)</b>	(18148-7, LN, "Left Ventricular End Systolic Volume")	(G-C036, SRT, "Measurement Method") = (125211, DCM, "Biplane Ellipse")

EF(bp el)	(18043-0, LN, "Left Ventricular Ejection Fraction")	(G-C036, SRT, "Measurement Method") = (125211, DCM, "Biplane Ellipse")
SV(bp el)	(F-32120, SRT, "Stroke Volume")	(G-C0E3, SRT, "Finding Site") = (T-32600, SRT, "Left Ventricle") (G-C036, SRT, "Measurement Method") = (125211, DCM, "Biplane Ellipse")
SI(bp el)	(F-00078, SRT, "Stroke Index")	(G-C0E3, SRT, "Finding Site") = (T-32600, SRT, "Left Ventricle") (G-C036, SRT, "Measurement Method") = (125211, DCM, "Biplane Ellipse")
CO(bp el)	(F-32100, SRT, "Cardiac Output")	(G-C0E3, SRT, "Finding Site") = (T-32600, SRT, "Left Ventricle") (G-C036, SRT, "Measurement Method") = (125211, DCM, "Biplane Ellipse")
CI(bp el)	(F-32110, SRT, "Cardiac Index")	(G-C0E3, SRT, "Finding Site") = (T-32600, SRT, "Left Ventricle") (G-C036, SRT, "Measurement Method") = (125211, DCM, "Biplane Ellipse")
LVd Mass(A-L)	(18087-7, LN, "Left Ventricle Mass")	(R-4089A, SRT, "Cardiac Cycle Point") = (F-32010, SRT, "Diastole") (G-C036, SRT, "Measurement Method") = (125205, DCM, "Area-Length Single Plane")
LVs Mass(A-L)	(18087-7, LN, "Left Ventricle Mass")	(R-4089A, SRT, "Cardiac Cycle Point") = (F-32020, SRT, "Systole") (G-C036, SRT, "Measurement Method") = (125205, DCM, "Area-Length Single Plane")
MM/IVSd	(18154-5, LN, "Interventricular Septum Diastolic Thickness")	(G-0373, SRT, "Image Mode") = (G-0394, SRT, "M mode")
MM/IVSs	(18158-6, LN, "Interventricular Septum Systolic Thickness")	(G-0373, SRT, "Image Mode") = (G-0394, SRT, "M mode")
MM/LVIDd	(29436-3, LN, "Left Ventricle Internal End Diastolic Dimension")	(G-0373, SRT, "Image Mode") = (G-0394, SRT, "M mode")

MM/LVIDs	(29438-9, LN, "Left Ventricle Internal Systolic Dimension")	(G-0373, SRT, "Image Mode") = (G-0394, SRT, "M mode")
MM/LVPWd	(18152-9, LN, "Left Ventricle Posterior Wall Diastolic Thickness")	(G-0373, SRT, "Image Mode") = (G-0394, SRT, "M mode")
MM/LVPWs	(18156-0, LN, "Left Ventricle Posterior Wall Systolic Thickness")	(G-0373, SRT, "Image Mode") = (G-0394, SRT, "M mode")
MM/EDV(Teich)	(18026-5, LN, "Left Ventricular End Diastolic Volume")	(G-0373, SRT, "Image Mode") = (G-0394, SRT, "M mode") (G-C036, SRT, "Measurement Method") = (125209, DCM, "Teichholz")
MM/ESV(Teich)	(18148-7, LN, "Left Ventricular End Systolic Volume")	(G-0373, SRT, "Image Mode") = (G-0394, SRT, "M mode") (G-C036, SRT, "Measurement Method") = (125209, DCM, "Teichholz")
MM/EF(Teich)	(18043-0, LN, "Left Ventricular Ejection Fraction")	(G-0373, SRT, "Image Mode") = (G-0394, SRT, "M mode") (G-C036, SRT, "Measurement Method") = (125209, DCM, "Teichholz")
MM/SV(Teich)	(F-32120, SRT, "Stroke Volume")	(G-C0E3, SRT, "Finding Site") = (T-32600, SRT, "Left Ventricle") (G-0373, SRT, "Image Mode") = (G-0394, SRT, "M mode") (G-C036, SRT, "Measurement Method") = (125209, DCM, "Teichholz")
MM/SI(Teich)	(F-00078, SRT, "Stroke Index")	(G-C0E3, SRT, "Finding Site") = (T-32600, SRT, "Left Ventricle") (G-0373, SRT, "Image Mode") = (G-0394, SRT, "M mode") (G-C036, SRT, "Measurement Method") = (125209, DCM, "Teichholz")
MM/CO(Teich)	(F-32100, SRT, "Cardiac Output")	(G-C0E3, SRT, "Finding Site") = (T-32600, SRT, "Left Ventricle") (G-0373, SRT, "Image Mode") = (G-0394, SRT, "M mode") (G-C036, SRT, "Measurement Method") = (125209, DCM, "Teichholz")

MM/CI(Teich)	(F-32110, SRT, "Cardiac Index")	(G-C0E3, SRT, "Finding Site") = (T-32600, SRT, "Left Ventricle") (G-0373, SRT, "Image Mode") = (G-0394, SRT, "M mode") (G-C036, SRT, "Measurement Method") = (125209, DCM, "Teichholz")
MM/EDV(Cube)	(18026-5, LN, "Left Ventricular End Diastolic Volume")	(G-0373, SRT, "Image Mode") = (G-0394, SRT, "M mode") (G-C036, SRT, "Measurement Method") = (125206, DCM, "Cube Method")
MM/ESV(Cube)	(18148-7, LN, "Left Ventricular End Systolic Volume")	(G-0373, SRT, "Image Mode") = (G-0394, SRT, "M mode") (G-C036, SRT, "Measurement Method") = (125206, DCM, "Cube Method")
MM/EF(Cube)	(18043-0, LN, "Left Ventricular Ejection Fraction")	(G-0373, SRT, "Image Mode") = (G-0394, SRT, "M mode") (G-C036, SRT, "Measurement Method") = (125206, DCM, "Cube Method")
MM/SV(Cube)	(F-32120, SRT, "Stroke Volume")	(G-C0E3, SRT, "Finding Site") = (T-32600, SRT, "Left Ventricle") (G-0373, SRT, "Image Mode") = (G-0394, SRT, "M mode") (G-C036, SRT, "Measurement Method") = (125206, DCM, "Cube Method")
MM/SI(Cube)	(F-00078, SRT, "Stroke Index")	(G-C0E3, SRT, "Finding Site") = (T-32600, SRT, "Left Ventricle") (G-0373, SRT, "Image Mode") = (G-0394, SRT, "M mode") (G-C036, SRT, "Measurement Method") = (125206, DCM, "Cube Method")
MM/CO(Cube)	(F-32100, SRT, "Cardiac Output")	(G-C0E3, SRT, "Finding Site") = (T-32600, SRT, "Left Ventricle") (G-0373, SRT, "Image Mode") = (G-0394, SRT, "M mode") (G-C036, SRT, "Measurement Method") = (125206, DCM, "Cube Method")
MM/CI(Cube)	(F-32110, SRT, "Cardiac Index")	(G-C0E3, SRT, "Finding Site") = (T-32600, SRT, "Left Ventricle") (G-0373, SRT, "Image Mode") = (G-0394, SRT, "M mode") (G-C036, SRT, "Measurement Method") = (125206, DCM, "Cube Method")

MM/%FS	(18051-3, LN, "Left Ventricular Fractional Shortening")	(G-0373, SRT, "Image Mode") = (G-0394, SRT, "M mode")
MM/IVSd/LVPWd	(18155-2, LN, "Interventricular Septum to Posterior Wall Thickness Ratio")	(G-0373, SRT, "Image Mode") = (G-0394, SRT, "M mode") (R-4089A, SRT, "Cardiac Cycle Point") = (F-32010, SRT, "Diastole")
MM/%LVPW Thck	(18053-9, LN, "Left Ventricle Posterior Wall % Thickening")	(G-0373, SRT, "Image Mode") = (G-0394, SRT, "M mode")
MM/LVd Mass	(18087-7, LN, "Left Ventricle Mass")	(G-0373, SRT, "Image Mode") = (G-0394, SRT, "M mode") (R-4089A, SRT, "Cardiac Cycle Point") = (F-32010, SRT, "Diastole")
MM/LVs Mass	(18087-7, LN, "Left Ventricle Mass")	(G-0373, SRT, "Image Mode") = (G-0394, SRT, "M mode") (R-4089A, SRT, "Cardiac Cycle Point") = (F-32020, SRT, "Systole")
MM/LVd Mass/ASE	(18087-7, LN, "Left Ventricle Mass")	(G-0373, SRT, "Image Mode") = (G-0394, SRT, "M mode") (R-4089A, SRT, "Cardiac Cycle Point") = (F-32010, SRT, "Diastole") (G-C036, SRT, "Measurement Method") = (125221, DCM, "Left Ventricle Mass by M-mode")
MM/LVs Mass/ASE	(18087-7, LN, "Left Ventricle Mass")	(G-0373, SRT, "Image Mode") = (G-0394, SRT, "M mode") (R-4089A, SRT, "Cardiac Cycle Point") = (F-32020, SRT, "Systole") (G-C036, SRT, "Measurement Method") = (125221, DCM, "Left Ventricle Mass by M-mode")
MM/HeartRate	(8867-4, LN, "Heart rate")	(G-0373, SRT, "Image Mode") = (G-0394, SRT, "M mode")
SD/HeartRate	(8867-4, LN, "Heart rate")	(G-0373, SRT, "Image Mode") = (R-409E4, SRT, "Doppler Pulsed")
SD/HeartRate/Calc	(8867-4, LN, "Heart rate")	(G-0373, SRT, "Image Mode") = (R-409E4, SRT, "Doppler Pulsed")
IVCT	(G-037E, SRT, "Left Ventricular Isovolumic	

	Contraction Time")	
IVRT	(18071-1, LN, "Left Ventricular Isovolumic Relaxation Time")	
MP/LVOT Diam	(G-038F, SRT, "Cardiovascular Orifice Diameter")	(G-C0E3, SRT, "Finding Site") = (T-32650, SRT, "Left Ventricle Outflow Tract")
MP/LVOT VTI	(20354-7, LN, "Velocity Time Integral")	(G-C0E3, SRT, "Finding Site") = (T-32650, SRT, "Left Ventricle Outflow Tract")
LVOT Vmax	(11726-7, LN, "Peak Velocity")	(G-C0E3, SRT, "Finding Site") = (T-32650, SRT, "Left Ventricle Outflow Tract")
LVOT Vmax P	(11726-7, LN, "Peak Velocity")	(G-C0E3, SRT, "Finding Site") = (T-32650, SRT, "Left Ventricle Outflow Tract")
LVOT maxPG	(20247-3, LN, "Peak Gradient")	(G-C0E3, SRT, "Finding Site") = (T-32650, SRT, "Left Ventricle Outflow Tract")
LVOT Vmean	(20352-1, LN, "Mean Velocity")	(G-C0E3, SRT, "Finding Site") = (T-32650, SRT, "Left Ventricle Outflow Tract")
LVOT meanPG	(20256-4, LN, "Mean Gradient")	(G-C0E3, SRT, "Finding Site") = (T-32650, SRT, "Left Ventricle Outflow Tract")
LVOT VTI	(20354-7, LN, "Velocity Time Integral")	(G-C0E3, SRT, "Finding Site") = (T-32650, SRT, "Left Ventricle Outflow Tract")
LVOT HR	(8867-4, LN, "Heart rate")	
LVOT SV	(F-32120, SRT, "Stroke Volume")	(G-C0E3, SRT, "Finding Site") = (T-32650, SRT, "Left Ventricle Outflow Tract")
LVOT SI	(F-00078, SRT, "Stroke Index")	(G-C0E3, SRT, "Finding Site") = (T-32650, SRT, "Left Ventricle Outflow Tract")
LVOT CO	(F-32100, SRT, "Cardiac Output")	(G-C0E3, SRT, "Finding Site") = (T-32650, SRT, "Left Ventricle Outflow Tract")
LVOT CI	(F-32110, SRT, "Cardiac Index")	(G-C0E3, SRT, "Finding Site") = (T-32650, SRT, "Left Ventricle Outflow Tract")

LIMP	(G-037F, SRT, "Left Ventricular Index of Myocardial Performance")	
AP/LVOT Diam	(G-038F, SRT, "Cardiovascular Orifice Diameter")	(G-C0E3, SRT, "Finding Site") = (T-32650, SRT, "Left Ventricle Outflow Tract")
AP/LVOT VTI	(20354-7, LN, "Velocity Time Integral")	(G-C0E3, SRT, "Finding Site") = (T-32650, SRT, "Left Ventricle Outflow Tract")
ECG/HeartRate	(8867-4, LN, "Heart rate")	

Section Right Ventricle

Name of GEU parameter	Base Measurement Concept Name	Concept or Acquisition Context Modifier
MM/RVOT	(G-038F, SRT, "Cardiovascular Orifice Diameter")	(G-C0E3, SRT, "Finding Site") = (T-32550, SRT, "Right Ventricle Outflow Tract") (G-0373, SRT, "Image Mode") = (G-0394, SRT, "M mode")
2D/RVOT Diam	(G-038F, SRT, "Cardiovascular Orifice Diameter")	(G-C0E3, SRT, "Finding Site") = (T-32550, SRT, "Right Ventricle Outflow Tract") (G-0373, SRT, "Image Mode") = (G-03A2, SRT, "2D mode") or (R-409E2, SRT, "Doppler Color Flow") depending on scan mode
2D/RVAWd	(18153-7, LN, "Right Ventricular Anterior Wall Diastolic Thickness")	(G-0373, SRT, "Image Mode") = (G-03A2, SRT, "2D mode") or (R-409E2, SRT, "Doppler Color Flow") depending on scan mode
2D/RVAWs	(18157-8, LN, "Right Ventricular Anterior Wall Systolic Thickness")	(G-0373, SRT, "Image Mode") = (G-03A2, SRT, "2D mode") or (R-409E2, SRT, "Doppler Color Flow") depending on scan mode
2D/RVIDd	(20304-2, LN, "Right Ventricular Internal Diastolic Dimension")	

2D/RVIDs	(20305-9, LN, "Right Ventricular Internal Systolic Dimension")	(G-0373, SRT, "Image Mode") = (G-03A2, SRT, "2D mode") or (R-409E2, SRT, "Doppler Color Flow") depending on scan mode
2D/RVOT Area	(G-038E, SRT, "Cardiovascular Orifice Area")	(G-C0E3, SRT, "Finding Site") = (T-32550, SRT, "Right Ventricle Outflow Tract") (G-0373, SRT, "Image Mode") = (G-03A2, SRT, "2D mode") or (R-409E2, SRT, "Doppler Color Flow") depending on scan mode
MM/RVIDs	(20305-9, LN, "Right Ventricular Internal Systolic Dimension")	(G-0373, SRT, "Image Mode") = (G-0394, SRT, "M mode")
MM/RVAVd	(18153-7, LN, "Right Ventricular Anterior Wall Diastolic Thickness")	(G-0373, SRT, "Image Mode") = (G-0394, SRT, "M mode")
MM/RVAVs	(18157-8, LN, "Right Ventricular Anterior Wall Systolic Thickness")	(G-0373, SRT, "Image Mode") = (G-0394, SRT, "M mode")
Est RVSP	(G-0380, SRT, "Right Ventricular Peak Systolic Pressure")	
RVOT Vmax	(11726-7, LN, "Peak Velocity")	(G-C0E3, SRT, "Finding Site") = (T-32550, SRT, "Right Ventricle Outflow Tract")
RVOT Vmax P	(11726-7, LN, "Peak Velocity")	(G-C0E3, SRT, "Finding Site") = (T-32550, SRT, "Right Ventricle Outflow Tract")
RVOT maxPG	(20247-3, LN, "Peak Gradient")	(G-C0E3, SRT, "Finding Site") = (T-32550, SRT, "Right Ventricle Outflow Tract")
RVOT Vmean	(20352-1, LN, "Mean Velocity")	(G-C0E3, SRT, "Finding Site") = (T-32550, SRT, "Right Ventricle Outflow Tract")
RVOT meanPG	(20256-4, LN, "Mean Gradient")	(G-C0E3, SRT, "Finding Site") = (T-32550, SRT, "Right Ventricle Outflow Tract")
RVOT VTI	(20354-7, LN, "Velocity Time Integral")	(G-C0E3, SRT, "Finding Site") = (T-32550, SRT, "Right Ventricle Outflow Tract")
RVOT HR	(8867-4, LN, "Heart rate")	



<b>RVOT SV</b>	(F-32120, SRT, "Stroke Volume")	(G-C0E3, SRT, "Finding Site") = (T-32550, SRT, "Right Ventricle Outflow Tract")
<b>RVOT SI</b>	(F-00078, SRT, "Stroke Index")	(G-C0E3, SRT, "Finding Site") = (T-32550, SRT, "Right Ventricle Outflow Tract")
<b>RVOT CO</b>	(F-32100, SRT, "Cardiac Output")	(G-C0E3, SRT, "Finding Site") = (T-32550, SRT, "Right Ventricle Outflow Tract")
<b>RVOT CI</b>	(F-32110, SRT, "Cardiac Index")	(G-C0E3, SRT, "Finding Site") = (T-32550, SRT, "Right Ventricle Outflow Tract")
<b>RIMP</b>	(G-0381, SRT, "Right Ventricular Index of Myocardial Performance")	

Section Left Atrium

<b>Name of GEU parameter</b>	<b>Base Measurement Concept Name</b>	<b>Concept or Acquisition Context Modifier</b>
<b>2D/Ao/LA</b>	(17985-3, LN, "Left Atrium to Aortic Root Ratio")	(G-0373, SRT, "Image Mode") = (G-03A2, SRT, "2D mode") or (R-409E2, SRT, "Doppler Color Flow") depending on scan mode
<b>MM/Ao/LA</b>	(17985-3, LN, "Left Atrium to Aortic Root Ratio")	(G-0373, SRT, "Image Mode") = (G-0394, SRT, "M mode")
<b>MM/LAAo/LA/Ao</b>	(17985-3, LN, "Left Atrium to Aortic Root Ratio")	(G-0373, SRT, "Image Mode") = (G-0394, SRT, "M mode")
<b>MM/LAAo/Ao/LA</b>	(17985-3, LN, "Left Atrium to Aortic Root Ratio")	(G-0373, SRT, "Image Mode") = (G-0394, SRT, "M mode")
<b>2D/LA/Ao</b>	(17985-3, LN, "Left Atrium to Aortic Root Ratio")	(G-0373, SRT, "Image Mode") = (G-03A2, SRT, "2D mode") or (R-409E2, SRT, "Doppler Color Flow") depending on scan mode
<b>LAESV(A-L A4C)</b>	(G-0383, SRT, "Left Atrium Systolic Volume")	(111031, DCM, "Image View") = (G-A19C, SRT, "Apical four chamber") (G-C036, SRT, "Measurement Method") = (125205,

		DCM, "Area-Length Single Plane")
LAESV(MOD A4C)	(G-0383, SRT, "Left Atrium Systolic Volume")	(111031, DCM, "Image View") = (G-A19C, SRT, "Apical four chamber") (G-C036, SRT, "Measurement Method") = (125208, DCM, "Method of Disks, Single Plane")
LAESV(A-L A2C)	(G-0383, SRT, "Left Atrium Systolic Volume")	(111031, DCM, "Image View") = (G-A19B, SRT, "Apical two chamber") (G-C036, SRT, "Measurement Method") = (125205, DCM, "Area-Length Single Plane")
LAESV(MOD A2C)	(G-0383, SRT, "Left Atrium Systolic Volume")	(111031, DCM, "Image View") = (G-A19B, SRT, "Apical two chamber") (G-C036, SRT, "Measurement Method") = (125208, DCM, "Method of Disks, Single Plane")
MM/LA/Ao	(17985-3, LN, "Left Atrium to Aortic Root Ratio")	(G-0373, SRT, "Image Mode") = (G-0394, SRT, "M mode")
MM/LA	(29469-4, LN, "Left Atrium Antero-posterior Systolic Dimension")	(G-0373, SRT, "Image Mode") = (G-0394, SRT, "M mode")
2D/LAESV(A-L)	(G-0383, SRT, "Left Atrium Systolic Volume")	(G-0373, SRT, "Image Mode") = (G-03A2, SRT, "2D mode") or (R-409E2, SRT, "Doppler Color Flow") depending on scan mode (G-C036, SRT, "Measurement Method") = (125204, DCM, "Area-Length Biplane")

## Section Right Atrium

Name of GEU parameter	Base Measurement Concept Name	Concept or Acquisition Context Modifier
RAAs(A4C)	(17988-7, LN, "Right Atrium Systolic Area")	
RAP	(18070-3, LN, "Right Atrium Systolic Pressure")	

## Section Aortic Valve

Name of GEU parameter	Base Measurement Concept Name	Concept or Acquisition Context Modifier
2D/AVA/AV Diam	(G-038F, SRT, "Cardiovascular Orifice Diameter")	(G-C048, SRT, "Direction of Flow") = (R-42047, SRT, "Antegrade Flow") (G-0373, SRT, "Image Mode") = (G-03A2, SRT, "2D mode") or (R-409E2, SRT, "Doppler Color Flow") depending on scan mode
AV Dec Time	(20217-6, LN, "Deceleration Time")	(G-C048, SRT, "Direction of Flow") = (R-42047, SRT, "Antegrade Flow")
AV Dec Slope	(20216-8, LN, "Deceleration Slope")	(G-C048, SRT, "Direction of Flow") = (R-42047, SRT, "Antegrade Flow")
PISA/AR/RF	(G-0390, SRT, "Regurgitant Fraction")	(G-C036, SRT, "Measurement Method") = (125216, DCM, "Proximal Isovelocity Surface Area")
MM/AV Diam	(G-038F, SRT, "Cardiovascular Orifice Diameter")	(G-C048, SRT, "Direction of Flow") = (R-42047, SRT, "Antegrade Flow") (G-0373, SRT, "Image Mode") = (G-0394, SRT, "M mode")
2D/AV Diam	(G-038F, SRT, "Cardiovascular Orifice Diameter")	(G-C048, SRT, "Direction of Flow") = (R-42047, SRT, "Antegrade Flow") (G-0373, SRT, "Image Mode") = (G-03A2, SRT, "2D mode") or (R-409E2, SRT, "Doppler Color Flow") depending on scan mode
2D/AV Cusp	(17996-0, LN, "Aortic Valve Cusp Separation")	(G-0373, SRT, "Image Mode") = (G-03A2, SRT, "2D mode") or (R-409E2, SRT, "Doppler Color Flow") depending on scan mode
2D/LAX/Trans AVA diastole	(G-038E, SRT, "Cardiovascular Orifice Area")	(G-0373, SRT, "Image Mode") = (G-03A2, SRT, "2D mode") or (R-409E2, SRT, "Doppler Color Flow") depending on scan mode (R-4089A, SRT, "Cardiac Cycle Point") = (F-32010, SRT, "Diastole")
2D/LAX/Trans AVA systole	(G-038E, SRT, "Cardiovascular Orifice Area")	(G-0373, SRT, "Image Mode") = (G-03A2, SRT, "2D mode") or (R-409E2, SRT, "Doppler Color Flow") depending on scan mode (R-4089A, SRT, "Cardiac Cycle Point") = (F-32020, SRT, "Systole")
2D/SAX/Trans AVA diastole	(G-038E, SRT, "Cardiovascular Orifice Area")	(G-0373, SRT, "Image Mode") = (G-03A2, SRT, "2D mode") or (R-409E2, SRT, "Doppler Color Flow") depending on scan mode (R-4089A, SRT, "Cardiac Cycle Point") = (F-32010, SRT, "Diastole")

		SRT, "Diastole")
2D/SAX/Trans AVA systole	(G-038E, SRT, "Cardiovascular Orifice Area")	(G-0373, SRT, "Image Mode") = (G-03A2, SRT, "2D mode") or (R-409E2, SRT, "Doppler Color Flow") depending on scan mode (R-4089A, SRT, "Cardiac Cycle Point") = (F-32020, SRT, "Systole")
2D/AVA Planimetry	(G-038E, SRT, "Cardiovascular Orifice Area")	(G-C048, SRT, "Direction of Flow") = (R-42047, SRT, "Antegrade Flow") (G-0373, SRT, "Image Mode") = (G-03A2, SRT, "2D mode") or (R-409E2, SRT, "Doppler Color Flow") depending on scan mode (G-C036, SRT, "Measurement Method") = (125220, DCM, "Planimetry")
2D/AV Area	(G-038E, SRT, "Cardiovascular Orifice Area")	(G-C048, SRT, "Direction of Flow") = (R-42047, SRT, "Antegrade Flow") (G-0373, SRT, "Image Mode") = (G-03A2, SRT, "2D mode") or (R-409E2, SRT, "Doppler Color Flow") depending on scan mode
MM/AV Cusp	(17996-0, LN, "Aortic Valve Cusp Separation")	(G-0373, SRT, "Image Mode") = (G-0394, SRT, "M mode")
AV Vmax	(11726-7, LN, "Peak Velocity")	(G-C048, SRT, "Direction of Flow") = (R-42047, SRT, "Antegrade Flow")
AV Vmax P	(11726-7, LN, "Peak Velocity")	(G-C048, SRT, "Direction of Flow") = (R-42047, SRT, "Antegrade Flow")
AV maxPG	(20247-3, LN, "Peak Gradient")	(G-C048, SRT, "Direction of Flow") = (R-42047, SRT, "Antegrade Flow")
AV Vmean	(20352-1, LN, "Mean Velocity")	(G-C048, SRT, "Direction of Flow") = (R-42047, SRT, "Antegrade Flow")
AV meanPG	(20256-4, LN, "Mean Gradient")	(G-C048, SRT, "Direction of Flow") = (R-42047, SRT, "Antegrade Flow")
AV Acc Time	(20168-1, LN, "Acceleration Time")	(G-C048, SRT, "Direction of Flow") = (R-42047, SRT, "Antegrade Flow")
AV VTI	(20354-7, LN, "Velocity Time Integral")	(G-C048, SRT, "Direction of Flow") = (R-42047, SRT, "Antegrade Flow")
AVA (VTI)	(G-038E, SRT, "Cardiovascular Orifice ...")	(G-C048, SRT, "Direction of Flow") = (R-42047, SRT, "Antegrade Flow") (G-C036, SRT, "Measurement Method") = (125215,

	Area"))	DCM, "Continuity Equation by Velocity Time Integral")
AVA (Vmax)	(G-038E, SRT, "Cardiovascular Orifice Area")	(G-C048, SRT, "Direction of Flow") = (R-42047, SRT, "Antegrade Flow") (G-C036, SRT, "Measurement Method") = (125214, DCM, "Continuity Equation by Peak Velocity")
AVA (Vmax)2	(G-038E, SRT, "Cardiovascular Orifice Area")	(G-C048, SRT, "Direction of Flow") = (R-42047, SRT, "Antegrade Flow") (G-C036, SRT, "Measurement Method") = (125214, DCM, "Continuity Equation by Peak Velocity")
AVA (Vmax)P	(G-038E, SRT, "Cardiovascular Orifice Area")	(G-C048, SRT, "Direction of Flow") = (R-42047, SRT, "Antegrade Flow") (G-C036, SRT, "Measurement Method") = (125214, DCM, "Continuity Equation by Peak Velocity")
AVA (Vmax)P2	(G-038E, SRT, "Cardiovascular Orifice Area")	(G-C048, SRT, "Direction of Flow") = (R-42047, SRT, "Antegrade Flow") (G-C036, SRT, "Measurement Method") = (125214, DCM, "Continuity Equation by Peak Velocity")
AV SV	(F-32120, SRT, "Stroke Volume")	(G-C0E3, SRT, "Finding Site") = (T-42000, SRT, "Aorta")
AV HR	(8867-4, LN, "Heart rate")	
AV SI	(F-00078, SRT, "Stroke Index")	(G-C0E3, SRT, "Finding Site") = (T-42000, SRT, "Aorta")
AV CO	(F-32100, SRT, "Cardiac Output")	(G-C0E3, SRT, "Finding Site") = (T-42000, SRT, "Aorta")
AV CI	(F-32110, SRT, "Cardiac Index")	(G-C0E3, SRT, "Finding Site") = (T-42000, SRT, "Aorta")
AVET	(18041-4, LN, "Aortic Valve Ejection Time")	
AV Acc Time/ET Ratio	(G-0382, SRT, "Ratio of Aortic Valve Acceleration Time to Ejection Time")	
AR PHT	(20280-4, LN, "Pressure Half-Time")	(G-C048, SRT, "Direction of Flow") = (R-42E61, SRT, "Regurgitant Flow")

AR Dec Time	(20217-6, LN, "Deceleration Time")	(G-C048, SRT, "Direction of Flow") = (R-42E61, SRT, "Regurgitant Flow")
AR Dec Slope	(20216-8, LN, "Deceleration Slope")	(G-C048, SRT, "Direction of Flow") = (R-42E61, SRT, "Regurgitant Flow")
AR Vmax	(11726-7, LN, "Peak Velocity")	(G-C048, SRT, "Direction of Flow") = (R-42E61, SRT, "Regurgitant Flow")
AR maxPG	(20247-3, LN, "Peak Gradient")	(G-C048, SRT, "Direction of Flow") = (R-42E61, SRT, "Regurgitant Flow")
ARend Vmax	(11726-7, LN, "Peak Velocity")	(G-C048, SRT, "Direction of Flow") = (R-42E61, SRT, "Regurgitant Flow") (R-4089A, SRT, "Cardiac Cycle Point") = (F-32011, SRT, "End Diastole")
ARend maxPG	(20247-3, LN, "Peak Gradient")	(G-C048, SRT, "Direction of Flow") = (R-42E61, SRT, "Regurgitant Flow") (R-4089A, SRT, "Cardiac Cycle Point") = (F-32011, SRT, "End Diastole")
AR Vmean	(20352-1, LN, "Mean Velocity")	(G-C048, SRT, "Direction of Flow") = (R-42E61, SRT, "Regurgitant Flow")
AR meanPG	(20256-4, LN, "Mean Gradient")	(G-C048, SRT, "Direction of Flow") = (R-42E61, SRT, "Regurgitant Flow")
AR VTI	(20354-7, LN, "Velocity Time Integral")	(G-C048, SRT, "Direction of Flow") = (R-42E61, SRT, "Regurgitant Flow")
PISA/AR/Flow	(34141-2, LN, "Peak Instantaneous Flow Rate")	(G-C048, SRT, "Direction of Flow") = (R-42E61, SRT, "Regurgitant Flow") (G-C036, SRT, "Measurement Method") = (125216, DCM, "Proximal Isovelocity Surface Area")
PISA/AR/Vmax	(11726-7, LN, "Peak Velocity")	(G-C048, SRT, "Direction of Flow") = (R-42E61, SRT, "Regurgitant Flow") (G-C036, SRT, "Measurement Method") = (125216, DCM, "Proximal Isovelocity Surface Area")
PISA/AR/VTI	(20354-7, LN, "Velocity Time Integral")	(G-C048, SRT, "Direction of Flow") = (R-42E61, SRT, "Regurgitant Flow") (G-C036, SRT, "Measurement Method") = (125216, DCM, "Proximal Isovelocity Surface Area")
PISA/AR/ERO	(G-038E, SRT, "Cardiovascular Orifice")	(G-C048, SRT, "Direction of Flow") = (R-42E61, SRT, "Regurgitant Flow")

	Area"))	(G-C036, SRT, "Measurement Method") = (125216, DCM, "Proximal Isovelocity Surface Area")
PISA/AR/RV	(33878-0, LN, "Volume Flow")	(G-C048, SRT, "Direction of Flow") = (R-42E61, SRT, "Regurgitant Flow") (G-C036, SRT, "Measurement Method") = (125216, DCM, "Proximal Isovelocity Surface Area")

## Section Mitral Valve

Name of GEU parameter	Base Measurement Concept Name	Concept or Acquisition Context Modifier
MR dp/dt	(18035-6, LN, "Mitral Regurgitation dP/dt derived from Mitral Reg velocity")	
PISA/MR/RF	(G-0390, SRT, "Regurgitant Fraction")	(G-C036, SRT, "Measurement Method") = (125216, DCM, "Proximal Isovelocity Surface Area")
2D/MV Annulus Diam	(G-038F, SRT, "Cardiovascular Orifice Diameter")	(G-C0E3, SRT, "Finding Site") = (T-35313, SRT, "Mitral Annulus") (G-C048, SRT, "Direction of Flow") = (R-42047, SRT, "Antegrade Flow") (G-0373, SRT, "Image Mode") = (G-03A2, SRT, "2D mode") or (R-409E2, SRT, "Doppler Color Flow") depending on scan mode
2D/SAX/MVA	(G-038E, SRT, "Cardiovascular Orifice Area")	(G-C048, SRT, "Direction of Flow") = (R-42047, SRT, "Antegrade Flow") (G-0373, SRT, "Image Mode") = (G-03A2, SRT, "2D mode") or (R-409E2, SRT, "Doppler Color Flow") depending on scan mode (111031, DCM, "Image View") = (G-0397, SRT, "Parasternal short axis")
2D/MVA Planimetry	(G-038E, SRT, "Cardiovascular Orifice Area")	(G-C048, SRT, "Direction of Flow") = (R-42047, SRT, "Antegrade Flow") (G-0373, SRT, "Image Mode") = (G-03A2, SRT, "2D mode") or (R-409E2, SRT, "Doppler Color Flow") depending on scan mode (G-C036, SRT, "Measurement Method") = (125220, DCM, "Planimetry")
2D/MV Area	(G-038E, SRT, "Cardiovascular Orifice Area")	(G-C048, SRT, "Direction of Flow") = (R-42047, SRT, "Antegrade Flow") (G-0373, SRT, "Image Mode") = (G-03A2, SRT, "2D mode") or (R-409E2, SRT, "Doppler Color Flow") depending on scan mode

	Area"))	mode")) or (R-409E2, SRT, "Doppler Color Flow") depending on scan mode
MM/EPSS	(18036-4, LN, "Mitral Valve EPSS, E wave")	(G-0373, SRT, "Image Mode") = (G-0394, SRT, "M mode")
MM/MV E-F Slope	(18040-6, LN, "Mitral Valve E-F Slope by M-Mode")	
MM/MV E/A Ratio	(18038-0, LN, "Mitral Valve E to A Ratio")	(G-0373, SRT, "Image Mode") = (G-0394, SRT, "M mode")
MV Acc Time	(20168-1, LN, "Acceleration Time")	(G-C048, SRT, "Direction of Flow") = (R-42047, SRT, "Antegrade Flow")
MV A Dur	(G-0385, SRT, "Mitral Valve A-Wave Duration")	
MV E Velocity	(18037-2, LN, "Mitral Valve E-Wave Peak Velocity")	
MV A Velocity	(17978-8, LN, "Mitral Valve A-Wave Peak Velocity")	
MV Dec Time	(20217-6, LN, "Deceleration Time")	(G-C048, SRT, "Direction of Flow") = (R-42047, SRT, "Antegrade Flow")
MV PHT	(20280-4, LN, "Pressure Half-Time")	(G-C048, SRT, "Direction of Flow") = (R-42047, SRT, "Antegrade Flow")
MV Dec Slope	(20216-8, LN, "Deceleration Slope")	(G-C048, SRT, "Direction of Flow") = (R-42047, SRT, "Antegrade Flow")
MVA (PHT)	(G-038E, SRT, "Cardiovascular Orifice Area")	(G-C048, SRT, "Direction of Flow") = (R-42047, SRT, "Antegrade Flow") (G-C036, SRT, "Measurement Method") = (125210, DCM, "Area by Pressure Half-Time")
MVA (VTI)	(G-038E, SRT, "Cardiovascular Orifice Area")	(G-C048, SRT, "Direction of Flow") = (R-42047, SRT, "Antegrade Flow") (G-C036, SRT, "Measurement Method") = (125215, DCM, "Continuity Equation by Velocity Time Integral")



MV meanPG	(20256-4, LN, "Mean Gradient")	(G-C048, SRT, "Direction of Flow") = (R-42047, SRT, "Antegrade Flow")
MV Vmax	(11726-7, LN, "Peak Velocity")	(G-C048, SRT, "Direction of Flow") = (R-42047, SRT, "Antegrade Flow")
MV Vmean	(20352-1, LN, "Mean Velocity")	(G-C048, SRT, "Direction of Flow") = (R-42047, SRT, "Antegrade Flow")
MV maxPG	(20247-3, LN, "Peak Gradient")	(G-C048, SRT, "Direction of Flow") = (R-42047, SRT, "Antegrade Flow")
MV VTI	(20354-7, LN, "Velocity Time Integral")	(G-C048, SRT, "Direction of Flow") = (R-42047, SRT, "Antegrade Flow")
MV HR	(8867-4, LN, "Heart rate")	
MV SV	(F-32120, SRT, "Stroke Volume")	(G-C0E3, SRT, "Finding Site") = (T-35300, SRT, "Mitral Valve")
MV SI	(F-00078, SRT, "Stroke Index")	(G-C0E3, SRT, "Finding Site") = (T-35300, SRT, "Mitral Valve")
MV CO	(F-32100, SRT, "Cardiac Output")	(G-C0E3, SRT, "Finding Site") = (T-35300, SRT, "Mitral Valve")
MV CI	(F-32110, SRT, "Cardiac Index")	(G-C0E3, SRT, "Finding Site") = (T-35300, SRT, "Mitral Valve")
MV E/A Ratio	(18038-0, LN, "Mitral Valve E to A Ratio")	
MV Acc Time/MV Dec Time	(G-0386, SRT, "Mitral Valve AT/DT Ratio")	
MR Vmax	(11726-7, LN, "Peak Velocity")	(G-C048, SRT, "Direction of Flow") = (R-42E61, SRT, "Regurgitant Flow")
MR meanPG	(20256-4, LN, "Mean Gradient")	(G-C048, SRT, "Direction of Flow") = (R-42E61, SRT, "Regurgitant Flow")
MR Vmean	(20352-1, LN, "Mean Velocity")	(G-C048, SRT, "Direction of Flow") = (R-42E61, SRT, "Regurgitant Flow")

MR maxPG	(20247-3, LN, "Peak Gradient")	(G-C048, SRT, "Direction of Flow") = (R-42E61, SRT, "Regurgitant Flow")
MR VTI	(20354-7, LN, "Velocity Time Integral")	(G-C048, SRT, "Direction of Flow") = (R-42E61, SRT, "Regurgitant Flow")
MCO	(G-0387, SRT, "Mitral Valve Closure to Opening Time")	
PISA/MR/Flow	(34141-2, LN, "Peak Instantaneous Flow Rate")	(G-C048, SRT, "Direction of Flow") = (R-42E61, SRT, "Regurgitant Flow") (G-C036, SRT, "Measurement Method") = (125216, DCM, "Proximal Isovelocity Surface Area")
PISA/MR/Vmax	(11726-7, LN, "Peak Velocity")	(G-C048, SRT, "Direction of Flow") = (R-42E61, SRT, "Regurgitant Flow") (G-C036, SRT, "Measurement Method") = (125216, DCM, "Proximal Isovelocity Surface Area")
PISA/MR/VTI	(20354-7, LN, "Velocity Time Integral")	(G-C048, SRT, "Direction of Flow") = (R-42E61, SRT, "Regurgitant Flow") (G-C036, SRT, "Measurement Method") = (125216, DCM, "Proximal Isovelocity Surface Area")
PISA/MR/ERO	(G-038E, SRT, "Cardiovascular Orifice Area")	(G-C048, SRT, "Direction of Flow") = (R-42E61, SRT, "Regurgitant Flow") (G-C036, SRT, "Measurement Method") = (125216, DCM, "Proximal Isovelocity Surface Area")
PISA/MR/RV	(33878-0, LN, "Volume Flow")	(G-C048, SRT, "Direction of Flow") = (R-42E61, SRT, "Regurgitant Flow") (G-C036, SRT, "Measurement Method") = (125216, DCM, "Proximal Isovelocity Surface Area")

## Section Pulmonic Valve

Name of GEU parameter	Base Measurement Concept Name	Concept or Acquisition Context Modifier
2D/PV Annulus Diam	(G-038F, SRT, "Cardiovascular Orifice Diameter")	(G-C048, SRT, "Direction of Flow") = (R-42047, SRT, "Antegrade Flow") (G-0373, SRT, "Image Mode") = (G-03A2, SRT, "2D mode") or (R-409E2, SRT, "Doppler Color Flow") depending on scan mode

2D/PV Area	(G-038E, SRT, "Cardiovascular Orifice Area")	(G-C048, SRT, "Direction of Flow") = (R-42047, SRT, "Antegrade Flow") (G-0373, SRT, "Image Mode") = (G-03A2, SRT, "2D mode") or (R-409E2, SRT, "Doppler Color Flow") depending on scan mode
MM/Q-to-PV close	(20295-2, LN, "Time from Q wave to Pulmonic Valve Closes")	(G-0373, SRT, "Image Mode") = (G-0394, SRT, "M mode")
PV Vmax	(11726-7, LN, "Peak Velocity")	(G-C048, SRT, "Direction of Flow") = (R-42047, SRT, "Antegrade Flow")
PV Vmax P	(11726-7, LN, "Peak Velocity")	(G-C048, SRT, "Direction of Flow") = (R-42047, SRT, "Antegrade Flow")
PV maxPG	(20247-3, LN, "Peak Gradient")	(G-C048, SRT, "Direction of Flow") = (R-42047, SRT, "Antegrade Flow")
PV Vmean	(20352-1, LN, "Mean Velocity")	(G-C048, SRT, "Direction of Flow") = (R-42047, SRT, "Antegrade Flow")
PV meanPG	(20256-4, LN, "Mean Gradient")	(G-C048, SRT, "Direction of Flow") = (R-42047, SRT, "Antegrade Flow")
PV Acc Time	(20168-1, LN, "Acceleration Time")	(G-C048, SRT, "Direction of Flow") = (R-42047, SRT, "Antegrade Flow")
PV VTI	(20354-7, LN, "Velocity Time Integral")	(G-C048, SRT, "Direction of Flow") = (R-42047, SRT, "Antegrade Flow")
PVA (VTI)	(G-038E, SRT, "Cardiovascular Orifice Area")	(G-C048, SRT, "Direction of Flow") = (R-42047, SRT, "Antegrade Flow") (G-C036, SRT, "Measurement Method") = (125215, DCM, "Continuity Equation by Velocity Time Integral")
PVA (Vmax)	(G-038E, SRT, "Cardiovascular Orifice Area")	(G-C048, SRT, "Direction of Flow") = (R-42047, SRT, "Antegrade Flow") (G-C036, SRT, "Measurement Method") = (125214, DCM, "Continuity Equation by Peak Velocity")
PVA (Vmax)P	(G-038E, SRT, "Cardiovascular Orifice Area")	(G-C048, SRT, "Direction of Flow") = (R-42047, SRT, "Antegrade Flow") (G-C036, SRT, "Measurement Method") = (125214, DCM, "Continuity Equation by Peak Velocity")
PV HR	(8867-4, LN, "Heart	

	rate")	
PVET	(18042-2, LN, "Pulmonic Valve Ejection Time")	
SD/Q-to-PV close	(20295-2, LN, "Time from Q wave to Pulmonic Valve Closes")	(G-0373, SRT, "Image Mode") = (R-409E4, SRT, "Doppler Pulsed")
PV Acc Time/ET Ratio	(G-0388, SRT, "Ratio of Pulmonic Valve Acceleration Time to Ejection Time")	
PR PHT	(20280-4, LN, "Pressure Half-Time")	(G-C048, SRT, "Direction of Flow") = (R-42E61, SRT, "Regurgitant Flow")
PR Dec Time	(20217-6, LN, "Deceleration Time")	(G-C048, SRT, "Direction of Flow") = (R-42E61, SRT, "Regurgitant Flow")
PR Dec Slope	(20216-8, LN, "Deceleration Slope")	(G-C048, SRT, "Direction of Flow") = (R-42E61, SRT, "Regurgitant Flow")
PR Vmax	(11726-7, LN, "Peak Velocity")	(G-C048, SRT, "Direction of Flow") = (R-42E61, SRT, "Regurgitant Flow")
PR maxPG	(20247-3, LN, "Peak Gradient")	(G-C048, SRT, "Direction of Flow") = (R-42E61, SRT, "Regurgitant Flow")
PR Vmean	(20352-1, LN, "Mean Velocity")	(G-C048, SRT, "Direction of Flow") = (R-42E61, SRT, "Regurgitant Flow")
PR meanPG	(20256-4, LN, "Mean Gradient")	(G-C048, SRT, "Direction of Flow") = (R-42E61, SRT, "Regurgitant Flow")
PR VTI	(20354-7, LN, "Velocity Time Integral")	(G-C048, SRT, "Direction of Flow") = (R-42E61, SRT, "Regurgitant Flow")
PRend Vmax	(11726-7, LN, "Peak Velocity")	(G-C048, SRT, "Direction of Flow") = (R-42E61, SRT, "Regurgitant Flow") (R-4089A, SRT, "Cardiac Cycle Point") = (F-32011, SRT, "End Diastole")
PRend maxPG	(20247-3, LN, "Peak Gradient")	(G-C048, SRT, "Direction of Flow") = (R-42E61, SRT, "Regurgitant Flow") (R-4089A, SRT, "Cardiac Cycle Point") = (F-32011, SRT, "End Diastole")

PISA/PR/Flow	(34141-2, LN, "Peak Instantaneous Flow Rate")	(G-C048, SRT, "Direction of Flow") = (R-42E61, SRT, "Regurgitant Flow") (G-C036, SRT, "Measurement Method") = (125216, DCM, "Proximal Isovelocity Surface Area")
PISA/PR/Vmax	(11726-7, LN, "Peak Velocity")	(G-C048, SRT, "Direction of Flow") = (R-42E61, SRT, "Regurgitant Flow") (G-C036, SRT, "Measurement Method") = (125216, DCM, "Proximal Isovelocity Surface Area")
PISA/PR/VTI	(20354-7, LN, "Velocity Time Integral")	(G-C048, SRT, "Direction of Flow") = (R-42E61, SRT, "Regurgitant Flow") (G-C036, SRT, "Measurement Method") = (125216, DCM, "Proximal Isovelocity Surface Area")
PISA/PR/ERO	(G-038E, SRT, "Cardiovascular Orifice Area")	(G-C048, SRT, "Direction of Flow") = (R-42E61, SRT, "Regurgitant Flow") (G-C036, SRT, "Measurement Method") = (125216, DCM, "Proximal Isovelocity Surface Area")
PISA/PR/RV	(33878-0, LN, "Volume Flow")	(G-C048, SRT, "Direction of Flow") = (R-42E61, SRT, "Regurgitant Flow") (G-C036, SRT, "Measurement Method") = (125216, DCM, "Proximal Isovelocity Surface Area")

Section Tricuspid Valve

Name of GEU parameter	Base Measurement Concept Name	Concept or Acquisition Context Modifier
2D/TVA Planimetry	(G-038E, SRT, "Cardiovascular Orifice Area")	(G-C048, SRT, "Direction of Flow") = (R-42047, SRT, "Antegrade Flow") (G-0373, SRT, "Image Mode") = (G-03A2, SRT, "2D mode") or (R-409E2, SRT, "Doppler Color Flow") depending on scan mode (G-C036, SRT, "Measurement Method") = (125220, DCM, "Planimetry")
2D/TV Annulus Diam	(G-038F, SRT, "Cardiovascular Orifice Diameter")	(G-C0E3, SRT, "Finding Site") = (T-35111, SRT, "Tricuspid Annulus") (G-C048, SRT, "Direction of Flow") = (R-42047, SRT, "Antegrade Flow") (G-0373, SRT, "Image Mode") = (G-03A2, SRT, "2D mode") or (R-409E2, SRT, "Doppler Color Flow") depending on scan mode
2D/TV Area	(G-038E, SRT,	(G-C048, SRT, "Direction of Flow") = (R-42047, SRT,

	"Cardiovascular Orifice Area")	"Antegrade Flow") (G-0373, SRT, "Image Mode") = (G-03A2, SRT, "2D mode") or (R-409E2, SRT, "Doppler Color Flow") depending on scan mode
MM/Q-to-TV open	(20296-0, LN, "Time from Q wave to Tricuspid Valve Opens")	(G-0373, SRT, "Image Mode") = (G-0394, SRT, "M mode")
TV Acc Time	(20168-1, LN, "Acceleration Time")	(G-C048, SRT, "Direction of Flow") = (R-42047, SRT, "Antegrade Flow")
TV E Velocity	(18031-5, LN, "Tricuspid Valve E Wave Peak Velocity")	
TV A Velocity	(18030-7, LN, "Tricuspid Valve A Wave Peak Velocity")	
TV Dec Time	(20217-6, LN, "Deceleration Time")	(G-C048, SRT, "Direction of Flow") = (R-42047, SRT, "Antegrade Flow")
TV Dec Slope	(20216-8, LN, "Deceleration Slope")	(G-C048, SRT, "Direction of Flow") = (R-42047, SRT, "Antegrade Flow")
TV PHT	(20280-4, LN, "Pressure Half-Time")	(G-C048, SRT, "Direction of Flow") = (R-42047, SRT, "Antegrade Flow")
TVA	(G-038E, SRT, "Cardiovascular Orifice Area")	(G-C048, SRT, "Direction of Flow") = (R-42047, SRT, "Antegrade Flow")
TV meanPG	(20256-4, LN, "Mean Gradient")	(G-C048, SRT, "Direction of Flow") = (R-42047, SRT, "Antegrade Flow")
TV Vmax	(11726-7, LN, "Peak Velocity")	(G-C048, SRT, "Direction of Flow") = (R-42047, SRT, "Antegrade Flow")
TV Vmax P	(11726-7, LN, "Peak Velocity")	(G-C048, SRT, "Direction of Flow") = (R-42047, SRT, "Antegrade Flow")
TV Vmean	(20352-1, LN, "Mean Velocity")	(G-C048, SRT, "Direction of Flow") = (R-42047, SRT, "Antegrade Flow")
TV maxPG	(20247-3, LN, "Peak Gradient")	(G-C048, SRT, "Direction of Flow") = (R-42047, SRT, "Antegrade Flow")

TV VTI	(20354-7, LN, "Velocity Time Integral")	(G-C048, SRT, "Direction of Flow") = (R-42047, SRT, "Antegrade Flow")
TVA (VTI)	(G-038E, SRT, "Cardiovascular Orifice Area")	(G-C048, SRT, "Direction of Flow") = (R-42047, SRT, "Antegrade Flow") (G-C036, SRT, "Measurement Method") = (125215, DCM, "Continuity Equation by Velocity Time Integral")
TVA (Vmax)	(G-038E, SRT, "Cardiovascular Orifice Area")	(G-C048, SRT, "Direction of Flow") = (R-42047, SRT, "Antegrade Flow") (G-C036, SRT, "Measurement Method") = (125214, DCM, "Continuity Equation by Peak Velocity")
TVA (Vmax)P	(G-038E, SRT, "Cardiovascular Orifice Area")	(G-C048, SRT, "Direction of Flow") = (R-42047, SRT, "Antegrade Flow") (G-C036, SRT, "Measurement Method") = (125214, DCM, "Continuity Equation by Peak Velocity")
TV HR	(8867-4, LN, "Heart rate")	
TV E/A Ratio	(18039-8, LN, "Tricuspid Valve E to A Ratio")	
SD/Q-to-TV open	(20296-0, LN, "Time from Q wave to Tricuspid Valve Opens")	(G-0373, SRT, "Image Mode") = (R-409E4, SRT, "Doppler Pulsed")
TR meanPG	(20256-4, LN, "Mean Gradient")	(G-C048, SRT, "Direction of Flow") = (R-42E61, SRT, "Regurgitant Flow")
TR Vmax	(11726-7, LN, "Peak Velocity")	(G-C048, SRT, "Direction of Flow") = (R-42E61, SRT, "Regurgitant Flow")
TR Vmean	(20352-1, LN, "Mean Velocity")	(G-C048, SRT, "Direction of Flow") = (R-42E61, SRT, "Regurgitant Flow")
TR maxPG	(20247-3, LN, "Peak Gradient")	(G-C048, SRT, "Direction of Flow") = (R-42E61, SRT, "Regurgitant Flow")
TR VTI	(20354-7, LN, "Velocity Time Integral")	(G-C048, SRT, "Direction of Flow") = (R-42E61, SRT, "Regurgitant Flow")
TCO	(G-0389, SRT, "Tricuspid Valve Closure to Opening Time")	

PISA/TR/Flow	(34141-2, LN, "Peak Instantaneous Flow Rate")	(G-C048, SRT, "Direction of Flow") = (R-42E61, SRT, "Regurgitant Flow") (G-C036, SRT, "Measurement Method") = (125216, DCM, "Proximal Isovelocity Surface Area")
PISA/TR/Vmax	(11726-7, LN, "Peak Velocity")	(G-C048, SRT, "Direction of Flow") = (R-42E61, SRT, "Regurgitant Flow") (G-C036, SRT, "Measurement Method") = (125216, DCM, "Proximal Isovelocity Surface Area")
PISA/TR/VTI	(20354-7, LN, "Velocity Time Integral")	(G-C048, SRT, "Direction of Flow") = (R-42E61, SRT, "Regurgitant Flow") (G-C036, SRT, "Measurement Method") = (125216, DCM, "Proximal Isovelocity Surface Area")
PISA/TR/ERO	(G-038E, SRT, "Cardiovascular Orifice Area")	(G-C048, SRT, "Direction of Flow") = (R-42E61, SRT, "Regurgitant Flow") (G-C036, SRT, "Measurement Method") = (125216, DCM, "Proximal Isovelocity Surface Area")
PISA/TR/RV	(33878-0, LN, "Volume Flow")	(G-C048, SRT, "Direction of Flow") = (R-42E61, SRT, "Regurgitant Flow") (G-C036, SRT, "Measurement Method") = (125216, DCM, "Proximal Isovelocity Surface Area")

## Section Aorta

Name of GEU parameter	Base Measurement Concept Name	Concept or Acquisition Context Modifier
MM/LAAo/Ao Root Diam	(18015-8, LN, "Aortic Root Diameter")	(G-0373, SRT, "Image Mode") = (G-0394, SRT, "M mode")
2D/Ao Root Diam	(18015-8, LN, "Aortic Root Diameter")	(G-0373, SRT, "Image Mode") = (G-03A2, SRT, "2D mode") or (R-409E2, SRT, "Doppler Color Flow") depending on scan mode
2D/Ao Asc Diam	(18012-5, LN, "Ascending Aortic Diameter")	(G-0373, SRT, "Image Mode") = (G-03A2, SRT, "2D mode") or (R-409E2, SRT, "Doppler Color Flow") depending on scan mode
2D/Ao Arch Diam	(18011-7, LN, "Aortic Arch Diameter")	(G-0373, SRT, "Image Mode") = (G-03A2, SRT, "2D mode") or (R-409E2, SRT, "Doppler Color Flow") depending on scan mode
2D/Ao Desc Diam	(18013-3, LN, "Descending Aortic Diameter")	(G-0373, SRT, "Image Mode") = (G-03A2, SRT, "2D mode") or (R-409E2, SRT, "Doppler Color Flow")



<b>Diam</b>	<b>Diameter")</b>	<b>depending on scan mode</b>
<b>2D/Ao Isthmus</b>	<b>(18014-1, LN, "Aortic Isthmus Diameter")</b>	<b>(G-0373, SRT, "Image Mode") = (G-03A2, SRT, "2D mode") or (R-409E2, SRT, "Doppler Color Flow") depending on scan mode</b>
<b>MM/Ao Root Diam</b>	<b>(18015-8, LN, "Aortic Root Diameter")</b>	<b>(G-0373, SRT, "Image Mode") = (G-0394, SRT, "M mode")</b>

## Section Pulmonary artery

<b>Name of GEU parameter</b>	<b>Base Measurement Concept Name</b>	<b>Concept or Acquisition Context Modifier</b>
<b>2D/MPA</b>	<b>(18020-8, LN, "Main Pulmonary Artery Diameter")</b>	<b>(G-0373, SRT, "Image Mode") = (G-03A2, SRT, "2D mode") or (R-409E2, SRT, "Doppler Color Flow") depending on scan mode</b>
<b>2D/RPA</b>	<b>(18021-6, LN, "Right Pulmonary Artery Diameter")</b>	<b>(G-0373, SRT, "Image Mode") = (G-03A2, SRT, "2D mode") or (R-409E2, SRT, "Doppler Color Flow") depending on scan mode</b>
<b>2D/LPA</b>	<b>(18019-0, LN, "Left Pulmonary Artery Diameter")</b>	<b>(G-0373, SRT, "Image Mode") = (G-03A2, SRT, "2D mode") or (R-409E2, SRT, "Doppler Color Flow") depending on scan mode</b>
<b>MPA Vmax</b>	<b>(G-038A, SRT, "Main Pulmonary Artery Peak Velocity")</b>	

## Section Pulmonary Venous Structure

<b>Name of GEU parameter</b>	<b>Base Measurement Concept Name</b>	<b>Concept or Acquisition Context Modifier</b>
<b>P_Vein S</b>	<b>(29450-4, LN, "Pulmonary Vein Systolic Peak Velocity")</b>	
<b>P_Vein D</b>	<b>(29451-2, LN, "Pulmonary Vein Diastolic Peak Velocity")</b>	

P_Vein A	(29453-8, LN, "Pulmonary Vein Atrial Contraction Reversal Peak Velocity")	
P_Vein A Dur	(G-038B, SRT, "Pulmonary Vein A-Wave Duration")	
P_Vein S/D Ratio	(29452-0, LN, "Pulmonary Vein Systolic to Diastolic Ratio")	
P_Vein S VTI	(G-038C, SRT, "Pulmonary Vein S-Wave Velocity Time Integral")	
P_Vein D VTI	(G-038D, SRT, "Pulmonary Vein D-Wave Velocity Time Integral")	

Section Vena Cava

Name of GEU parameter	Base Measurement Concept Name	Concept or Acquisition Context Modifier
2D/IVC Diam Ins	(18006-7, LN, "Inferior Vena Cava Diameter")	(R-40899, SRT, "Respiratory Cycle Point") = (F-20010, SRT, "During Inspiration")
2D/IVC Diam Exp	(18006-7, LN, "Inferior Vena Cava Diameter")	(R-40899, SRT, "Respiratory Cycle Point") = (F-20020, SRT, "During Expiration")
2D/IVC	(18006-7, LN, "Inferior Vena Cava Diameter")	(G-0373, SRT, "Image Mode") = (G-03A2, SRT, "2D mode") or (R-409E2, SRT, "Doppler Color Flow") depending on scan mode

Section Cardiac Shunt Study

Name of GEU parameter	Base Measurement Concept Name	Concept or Acquisition Context Modifier
Qp/Qs	(29462-9, LN, "Pulmonary-to-Systemic")	

	Shunt Flow Ratio")	
--	--------------------	--

Section Congenital Anomaly of Cardiovascular System

Name of GEU parameter	Base Measurement Concept Name	Concept or Acquisition Context Modifier
2D/ASD Diam	(G-038F, SRT, "Cardiovascular Orifice Diameter")	(G-C0E3, SRT, "Finding Site") = (D4-31220, SRT, "Atrial Septal Defect") (G-0373, SRT, "Image Mode") = (G-03A2, SRT, "2D mode") or (R-409E2, SRT, "Doppler Color Flow") depending on scan mode
2D/VSD Diam	(G-038F, SRT, "Cardiovascular Orifice Diameter")	(G-C0E3, SRT, "Finding Site") = (D4-31150, SRT, "Ventricular Septal Defect") (G-0373, SRT, "Image Mode") = (G-03A2, SRT, "2D mode") or (R-409E2, SRT, "Doppler Color Flow") depending on scan mode
VSD Vmax	(11726-7, LN, "Peak Velocity")	(G-C0E3, SRT, "Finding Site") = (D4-31150, SRT, "Ventricular Septal Defect")
VSD maxPG	(20247-3, LN, "Peak Gradient")	(G-C0E3, SRT, "Finding Site") = (D4-31150, SRT, "Ventricular Septal Defect")
ASD Vmax	(11726-7, LN, "Peak Velocity")	(G-C0E3, SRT, "Finding Site") = (D4-31220, SRT, "Atrial Septal Defect")
ASD maxPG	(20247-3, LN, "Peak Gradient")	(G-C0E3, SRT, "Finding Site") = (D4-31220, SRT, "Atrial Septal Defect")