

Technical Publications

Direction 6308877-100

Revision 2.0

LOGIQ P6 PRO version 3.x.x **DICOM CONFORMANCE STATEMENT**

Copyright© 2010 by General Electric Co.

Do not duplicate



THIS PAGE LEFT INTENTIONALLY BLANK

REVISION HISTORY

Revision	Date	Description
1	2009/01/19	Release for LOGIQ P6 PRO BT09 M3 Add DICOM SR Table Add Cardiac DICOM SR Table and Parameters
2	2010/08/31	Release for LOGIQ P6 PRO BT11 M3

CONFORMANCE STATEMENT OVERVIEW

The LOGIQ P6 PRO is a self-contained networked computer system used for acquiring ultrasound diagnostic medical images. The system implements the necessary DICOM services to download work list from an information system, save acquired US images to a network storage device or media, print to a networked hardcopy device, query and move US images from a networked storage and inform the information system about the work actually done. The system conforms to the DICOM standard to allow the sharing of medical information with other digital imaging systems.

Table A.1 provides an overview of the network services supported by LOGIQ P6 PRO.

Table A.1 Network Services

SOP Classes	User of Service (SCU)	Provider of Service (SCP)
Transfer		
Verification	Yes	Yes
US Image Storage	Yes	Yes
US Multi-frame Storage	Yes	Yes
US Image Storage (retired)	Yes	Yes
US Multi-frame Storage (retired)	Yes	Yes
Secondary Capture Image Storage	Yes	Yes
Query/Retrieve		
Study Root Q/R – FIND	Yes	No
Study Root Q/R – MOVE	Yes	No
Print Management		
Basic Grayscale Print Management	Yes	No
Basic Color Print Management	Yes	No
Workflow Management		
Modality Worklist	Yes	No
Modality Performed Procedure	Yes	No
Storage Commitment Push Model	Yes	No
Notes, Reports, Measurements Transfer		
Comprehensive SR Storage	Yes	No

Table A.2 provides an overview of the Media Storage Application Profile supported by LOGIQ P6 PRO.

Table A.2 Media Services

Media Storage Augmented Profile	Write Files (FSC or FSU)	Read Files (FSR)
Compact Disk - R		
AUG-US-SC-SF-CDR, AUG-US-SC-MF-CDR, STD-US-SC-SF-CDR	Yes	Yes
DVD		
AUG-US-SC-SF-DVD, AUG-US-SC-MF-DVD, STD-US-SC-SF-DVD	Yes	Yes

TABLE OF CONTENTS

1. INTRODUCTION	1
1.1 Overview	1
1.2 OVERALL DICOM CONFORMANCE STATEMENT DOCUMENT STRUCTURE	2
1.3 INTENDED AUDIENCE	3
1.4 SCOPE AND FIELD OF APPLICATION	3
1.5 IMPORTANT REMARKS	3
1.6 REFERENCES	4
1.7 DEFINITIONS	4
1.8 SYMBOLS AND ABBREVIATIONS	6
2. NETWORK CONFORMANCE STATEMENT	8
2.1 INTRODUCTION	8
2.2 IMPLEMENTATION MODEL	8
2.2.1 Application Data Flow Diagram	8
2.2.2 Functional Definition of AE's.....	10
2.2.3 Sequencing of Real-World Activities.....	10
2.3 AE SPECIFICATIONS	11
2.3.1 LOGIQ P6 PRO AE Specification	11
2.4 COMMUNICATION PROFILES.....	20
2.4.1 Supported Communication Stacks (PS 3.8)	20
2.4.2 TCP/IP Stack	20
2.5 EXTENSIONS / SPECIALIZATIONS / PRIVATIZATIONS	20
2.6 CONFIGURATION.....	21
2.6.1 AE Title/Presentation Address Mapping.....	21

2.6.2 Configurable Parameters..... 21

2.7 SUPPORT OF EXTENDED CHARACTER SETS 22

2.8 CODES AND CONTROLLED TERMINOLOGY..... 22

2.8.1 Fixed Coded Terminology 22

2.9 SECURITY PROFILES 22

3. MEDIA STORAGE CONFORMANCE STATEMENT 23

3.1 INTRODUCTION 23

3.2 IMPLEMENTATION MODEL 23

3.2.1 Application Data Flow Diagram 23

3.2.2 Functional Definition of AE’s 23

3.2.3 Sequencing Requirements 23

3.2.4 File Meta Information Options (See PS3.10)..... 24

3.3 AE SPECIFICATIONS 24

3.3.1 LOGIQ P6 PRO AE Specification 24

3.4 AUGMENTED AND PRIVATE APPLICATION PROFILES..... 28

3.5 EXTENSIONS, SPECIALIZATIONS, PRIVATIZATIONS OF SOP CLASSES AND TRANSFER SYNTAXES..... 28

3.6 CONFIGURATION..... 28

3.7 SUPPORT OF EXTENDED CHARACTER SETS 28

4. ULTRASOUND (US) INFORMATION OBJECT IMPLEMENTATION 29

4.1 INTRODUCTION 29

4.2 US IOD IMPLEMENTATION 29

4.3 US ENTITY-RELATIONSHIP MODEL..... 29

4.3.1 Entity Descriptions 30

4.3.2 LOGIQ P6 PRO Mapping of DICOM Entities 30

4.4 IOD MODULE TABLE 31

4.5	INFORMATION MODULE DEFINITIONS	31
4.5.1	Common Patient Entity Modules	31
4.5.2	Common Study Entity Modules	32
4.5.3	Common Series Entity Modules.....	33
4.5.4	Common Equipment Entity Modules.....	34
4.5.5	Common Image Entity Modules	34
4.5.6	General Modules	37
4.5.7	US Modules	38
5.	ULTRASOUND MULTIFRAME (US MF) INFORMATION OBJECT IMPLEMENTATION	42
5.1	INTRODUCTION	42
5.2	US MF IOD IMPLEMENTATION	42
5.3	US MF ENTITY-RELATIONSHIP MODEL	42
5.3.1	Entity Descriptions.....	44
5.3.2	LOGIQ P6 PRO Mapping of DICOM entities	44
5.4	IOD MODULE TABLE.....	44
5.5	INFORMATION MODULE DEFINITIONS	45
5.5.1	Common Image Modules.....	45
6.	SC INFORMATION OBJECT IMPLEMENTATION.....	46
6.1	INTRODUCTION	46
6.2	SC IOD IMPLEMENTATION.....	46
6.3	SC ENTITY-RELATIONSHIP MODEL	46
6.3.1	Entity Descriptions.....	47
6.3.2	LOGIQ P6 PRO Mapping of DICOM Entities	47
6.4	IOD MODULE TABLE.....	48
6.5	INFORMATION MODULE DEFINITIONS	48

6.5.1	SC Modules	48
7.	SR INFORMATION OBJECT IMPLEMENTATION	50
7.1	INTRODUCTION	50
7.2	COMPREHENSIVE SR IOD IMPLEMENTATION	50
7.3	COMPREHENSIVE SR ENTITY-RELATIONSHIP MODEL	50
7.3.1	Entity Descriptions.....	51
7.3.2	LOGIQ P6 PRO Mapping of DICOM Entities.....	51
7.4	IOD MODULE TABLE.....	52
7.5	INFORMATION MODULE DEFINITIONS	52
7.5.1	SR Document Series Module.....	52
7.5.2	SR Document General Module	53
7.5.3	SR Document Content Module	54
7.6	STANDARD EXTENDED AND PRIVATE DATA ATTRIBUTES.....	55
7.7	STANDARD EXTENDED AND PRIVATE CONTEXT GROUPS.....	55
7.8	STANDARD EXTENDED AND PRIVATE TEMPLATES	55
7.8.1	Standard Extended Templates	55
7.8.2	Private Templates	72
8.	BASIC DIRECTORY INFORMATION OBJECT IMPLEMENTATION.....	74
8.1	INTRODUCTION	74
8.2	BASIC DIRECTORY IOD IMPLEMENTATION.....	74
8.3	IOD MODULE TABLE.....	74
8.4	INFORMATION MODULE DEFINITIONS	74
8.4.1	Common File Set Identification Modules	75
8.4.2	Common Directory Information Modules	75
8.4.3	Definition of Specific Directory Records.....	76

8.5	PRIVATE DATA DICTIONARY	80
9.	MODALITY WORKLIST INFORMATION MODEL DEFINITION.....	81
9.1	INTRODUCTION	81
9.2	MODALITY WORKLIST INFORMATION MODEL DESCRIPTION	81
9.3	MODALITY WORKLIST INFORMATION MODEL ENTITY-RELATIONSHIP MODEL	81
9.3.1	Entity Descriptions	82
9.3.2	LOGIQ P6 PRO Mapping of DICOM entities	83
9.4	INFORMATION MODEL MODULE TABLE.....	83
9.5	INFORMATION MODEL KEYS.....	84
9.5.1	Supported Matching	84
9.5.2	Scheduled Procedure Step Entity	84
9.5.3	Requested Procedure Entity.....	85
9.5.4	Imaging Service Request Entity.....	86
9.5.5	Visit Entity.....	86
9.5.6	Patient Entity.....	87
10.	MODALITY PERFORMED PROCEDURE STEP SOP CLASS DEFINITION	89
10.1	INTRODUCTION	89
10.2	MODALITY PERFORMED PROCEDURE STEP SOP CLASS DEFINITION	89
10.2.1	IOD Description.....	89
10.2.2	Operations	91
11.	STORAGE COMMITMENT PUSH MODEL SOP CLASS DEFINITION.....	92
11.1	INTRODUCTION	92
11.2	STORAGE COMMITMENT PUSH MODEL SOP CLASS DEFINITION	92
11.2.1	IOD Description	92
11.2.2	DIMSE Service Group.....	92

11.2.3	Operations	92
11.2.4	Notifications.....	93
12.	PRINT MANAGEMENT SOP CLASS DEFINITION	95
12.1	INTRODUCTION	95
12.2	BASIC PRINT MANAGEMENT META SOP CLASSES.....	95
12.2.1	Basic Grayscale Print Management Meta SOP Class.....	95
12.2.2	Basic Color Print Management Meta SOP Class.....	95
12.3	PRINT MANAGEMENT SOP CLASS DEFINITIONS	95
12.3.1	Basic Film Session SOP Class	96
12.3.2	Basic Film Box SOP Class	96
12.3.3	Image Box SOP Class	97
12.3.4	Printer SOP Class	97
12.4	PRINT MANAGEMENT IODS	98
12.4.1	Film Session IOD Module	98
12.4.2	Basic Film Box IOD Module Table	98
12.4.3	Basic Image Box IOD Module Table.....	98
12.4.4	Printer IOD Module Table.....	98
12.5	INFORMATION MODULE DEFINITIONS.....	99
12.5.1	General Modules	99
12.5.2	Print Management Modules.....	99
13.	STUDY ROOT QUERY/RETRIEVE INFORMATION MODEL DEFINITION	104
13.1	INTRODUCTION	104
13.2	STUDY ROOT INFORMATION MODEL DESCRIPTION	104
13.3	STUDY ROOT INFORMATION MODEL ENTITY-RELATIONSHIP MODEL.....	104
13.3.1	Entity Descriptions	105

13.3.2	LOGIQ P6 PRO Mapping of DICOM entities	105
13.4	INFORMATION MODEL KEYS	105
13.4.1	Supported Matching	106
13.4.2	Study Level	106
13.4.3	Series Level.....	107
13.4.4	Image Level	108
13.5	PRIVATE DATA DICTIONARY	108

1. INTRODUCTION

1.1 Overview

This DICOM Conformance Statement is divided into Sections as described below:

Section 1 (Introduction), which describes the overall structure, intent, and references for this Conformance Statement.

Section 2 (Network Conformance Statement), which specifies the GEMS equipment compliance to the DICOM requirements for the implementation of Networking features.

Section 3 (Media Storage Conformance Statement), which specifies the GEMS equipment compliance to the DICOM requirements for the implementation of Media Storage features.

Section 4 (Ultrasound Information Object Implementation), which specifies the GEMS equipment compliance to DICOM requirements for the implementation of an Ultrasound Medicine Information Object.

Section 5 (Ultrasound Multi-Frame Information Object Implementation), which specifies the GEMS equipment compliance to DICOM requirements for the implementation of an Ultrasound Multi-Frame Information.

Section 6 (SC Object Implementation), which specifies the GEMS equipment compliance to DICOM requirements for the implementation of a Secondary Capture Information Object.

Section 7 (SR Object Implementation), which specifies the GEMS equipment compliance to DICOM requirements for the implementation of a Comprehensive Structured Reporting Information Object.

Section 8 (Basic Directory Information Object Implementation), which specifies the GEMS equipment compliance to DICOM requirements for the implementation of a Basic Directory Information Object.

Section 9 (Modality Worklist Information Model), which specifies the GEMS equipment compliance to DICOM requirements for the implementation of the Modality Worklist service.

Section 10 (Modality Performed Procedure Step SOP Class Definition), which specifies the GEMS equipment compliance to DICOM requirements for the implementation of Modality Performed Procedure Step Service.

Section 11 (Storage Commitment Push Model SOP Class Definition), which specifies the GEMS equipment compliance to DICOM requirements for the implementation of the Storage Commitment Push Model Service.

Section 12 (Basic Print Meta SOP Class Information Object Implementation), which specifies the GEMS equipment compliance to DICOM requirements for the implementation of Basic Print Meta SOP Classes (Gray and Color).

Section 13 (Study Root Query/Retrieve Information Model), which specifies the GEMS equipment compliance to DICOM requirements for the Study Root Query/Retrieve Information Model.

1.2 OVERALL DICOM CONFORMANCE STATEMENT DOCUMENT STRUCTURE

The Documentation Structure of the GEHC Conformance Statements and their relationship with the DICOM Conformance Statements is shown in the Illustration below.

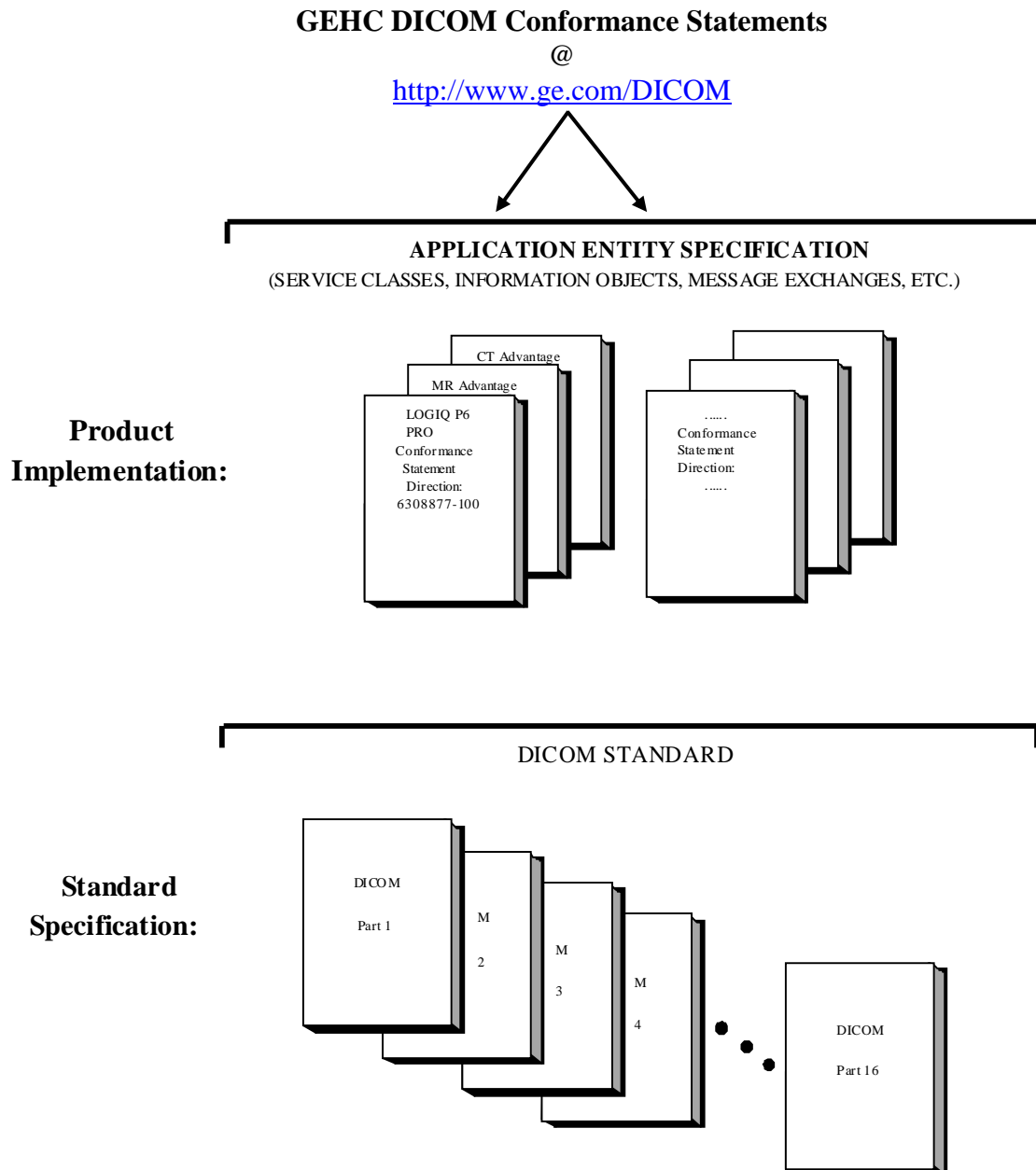

This document specifies the DICOM implementation. It is entitled:

LOGIQ P6 PRO version 3.x.x
Conformance Statement for DICOM
Direction 6308877-100

This DICOM Conformance Statement documents the DICOM Conformance Statement and Technical Specification required to interoperate with the GEHC network interface.

The GEHC Conformance Statement, contained in this document, also specifies the Lower Layer communications which it supports (e.g., TCP/IP). However, the Technical Specifications are defined in the DICOM Part 8 standard.

For more information regarding DICOM, copies of the Standard may be obtained on the Internet at <http://medical.nema.org>. Comments on the Standard may be addressed to:

DICOM Secretariat
NEMA
1300 N. 17th Street, Suite 1752
Rosslyn, VA 22209
USA
Phone: +1.703.841.3200

1.3 INTENDED AUDIENCE

The reader of this document is concerned with software design and/or system integration issues. It is assumed that the reader of this document is familiar with the DICOM Standard and with the terminology and concepts which are used in that Standard

1.4 SCOPE AND FIELD OF APPLICATION

It is the intent of this document to provide an unambiguous specification for GEHC implementations. This specification, called a Conformance Statement, includes a DICOM Conformance Statement and is necessary to ensure proper processing and interpretation of GEHC medical data exchanged using DICOM. The GEHC Conformance Statements are available to the public.

The reader of this DICOM Conformance Statement should be aware that different GEHC devices are capable of using different Information Object Definitions. For example, a GEHC CT Scanner may send images using the CT Information Object, MR Information Object, Secondary Capture Object, etc.

Included in this DICOM Conformance Statement are the Module Definitions which define all data elements used by this GEHC implementation. If the user encounters unspecified private data elements while parsing a GEHC Data Set, the user is well advised to ignore those data elements (per the DICOM standard). Unspecified private data element information is subject to change without notice. If, however, the device is acting as a "full fidelity storage device", it should retain and re-transmit all of the private data elements which are sent by GEHC devices.

1.5 IMPORTANT REMARKS

The use of these DICOM Conformance Statements, in conjunction with the DICOM Standards, is intended to facilitate communication with GE imaging equipment. However, **by itself, it is not sufficient to ensure that inter-operation will be successful**. The **user (or user's agent)** needs to proceed with caution and address at least four issues:

- **Integration** - The integration of any device into an overall system of interconnected devices goes beyond the scope of standards (DICOM v3.0), and of this introduction and associated DICOM Conformance Statements when interoperability with non-GE equipment is desired. The responsibility to analyze the applications requirements and to design a solution that integrates GE imaging equipment with non-GE systems is the **user's**

responsibility and should not be underestimated. The **user** is strongly advised to ensure that such an integration analysis is correctly performed.

- **Validation** - Testing the complete range of possible interactions between any GE device and non-GE devices, before the connection is declared operational, should not be overlooked. Therefore, the **user** should ensure that any non-GE provider accepts full responsibility for all validation required for their connection with GE devices. This includes the accuracy of the image data once it has crossed the interface between the GE imaging equipment and the non-GE device and the stability of the image data for the intended applications.
Such a validation is required before any clinical use (diagnosis and/or treatment) is performed. It applies when images acquired on GE imaging equipment are processed/displayed on a non-GE device, as well as when images acquired on non-GE equipment is processed/displayed on a GE console or workstation.
- **Future Evolution** - GE understands that the DICOM Standard will evolve to meet the user's growing requirements. GE is actively involved in the development of the DICOM Standard. DICOM will incorporate new features and technologies and GE may follow the evolution of the Standard. The GEHC protocol is based on DICOM as specified in each DICOM Conformance Statement. Evolution of the Standard may require changes to devices which have implemented DICOM. **In addition, GE reserves the right to discontinue or make changes to the support of communications features (on its products) described by these DICOM Conformance Statements.** The **user** should ensure that any non-GE provider, which connects with GE devices, also plans for the future evolution of the DICOM Standard. Failure to do so will likely result in the loss of function and/or connectivity as the DICOM Standard changes and GE Products are enhanced to support these changes.
- **Interaction** - It is the sole responsibility of the **non-GE provider** to ensure that communication with the interfaced equipment does not cause degradation of GE imaging equipment performance and/or function.

1.6 REFERENCES

NEMA PS3 Digital Imaging and Communications in Medicine (DICOM) Standard, available free at <http://medical.nema.org/>

1.7 DEFINITIONS

Informal definitions are provided for the following terms used in this Conformance Statement. The DICOM Standard is the authoritative source for formal definitions of these terms.

Abstract Syntax – the information agreed to be exchanged between applications, generally equivalent to a Service/Object Pair (SOP) Class. Examples : Verification SOP Class, Modality Worklist Information Model Find SOP Class, Computed Radiography Image Storage SOP Class.

Application Entity (AE) – an end point of a DICOM information exchange, including the DICOM network or media interface software; i.e., the software that sends or receives DICOM information objects or messages. A single device may have multiple Application Entities.

Application Entity Title – the externally known name of an *Application Entity*, used to identify a DICOM application to other DICOM applications on the network.

Application Context – the specification of the type of communication used between *Application Entities*. Example: DICOM network protocol.

Association – a network communication channel set up between *Application Entities*.

Attribute – a unit of information in an object definition; a data element identified by a *tag*. The information may be a complex data structure (Sequence), itself composed of lower level data elements. Examples: Patient ID (0010,0020), Accession Number (0008,0050), Photometric Interpretation (0028,0004), Procedure Code Sequence (0008,1032).

Information Object Definition (IOD) – the specified set of *Attributes* that comprise a type of data object; does not represent a specific instance of the data object, but rather a class of similar data objects that have the same properties. The *Attributes* may be specified as Mandatory (Type 1), Required but possibly unknown (Type 2), or Optional (Type 3), and there may be conditions associated with the use of an Attribute (Types 1C and 2C). Examples: MR Image IOD, CT Image IOD, Print Job IOD.

Joint Photographic Experts Group (JPEG) – a set of standardized image compression techniques, available for use by DICOM applications.

Media Application Profile – the specification of DICOM information objects and encoding exchanged on removable media (e.g., CDs)

Module – a set of *Attributes* within an *Information Object Definition* that are logically related to each other. Example: Patient Module includes Patient Name, Patient ID, Patient Birth Date, and Patient Sex.

Negotiation – first phase of *Association* establishment that allows *Application Entities* to agree on the types of data to be exchanged and how that data will be encoded.

Presentation Context – the set of DICOM network services used over an *Association*, as negotiated between *Application Entities*; includes *Abstract Syntaxes* and *Transfer Syntaxes*.

Protocol Data Unit (PDU) – a packet (piece) of a DICOM message sent across the network. Devices must specify the maximum size packet they can receive for DICOM messages.

Security Profile – a set of mechanisms, such as encryption, user authentication, or digital signatures, used by an *Application Entity* to ensure confidentiality, integrity, and/or availability of exchanged DICOM data

Service Class Provider (SCP) – role of an *Application Entity* that provides a DICOM network service; typically, a server that performs operations requested by another *Application Entity* (*Service Class User*). Examples: Picture Archiving and Communication System (image storage SCP, and image query/retrieve SCP), Radiology Information System (modality worklist SCP).

Service Class User (SCU) – role of an *Application Entity* that uses a DICOM network service; typically, a client. Examples: imaging modality (image storage SCU, and modality worklist SCU), imaging workstation (image query/retrieve SCU)

Service/Object Pair (SOP) Class – the specification of the network or media transfer (service) of a particular type of data (object); the fundamental unit of DICOM interoperability specification. Examples: Ultrasound Image Storage Service, Basic Grayscale Print Management.

Service/Object Pair (SOP) Instance – an information object; a specific occurrence of information exchanged in a *SOP Class*. Examples: a specific x-ray image.

Tag – a 32-bit identifier for a data element, represented as a pair of four digit hexadecimal numbers, the “group” and the “element”. If the “group” number is odd, the tag is for a private (manufacturer-specific) data element. Examples: (0010,0020) [Patient ID], (07FE,0010) [Pixel Data], (0019,0210) [private data element]

Transfer Syntax – the encoding used for exchange of DICOM information objects and messages. Examples: *JPEG* compressed (images), little endian explicit value representation.

Unique Identifier (UID) – a globally unique “dotted decimal” string that identifies a specific object or a class of objects; an ISO-8824 Object Identifier. Examples: Study Instance UID, SOP Class UID, SOP Instance UID.

Value Representation (VR) – the format type of an individual DICOM data element, such as text, an integer, a person’s name, or a code. DICOM information objects can be transmitted with either explicit identification of the type of each data

element (Explicit VR), or without explicit identification (Implicit VR); with Implicit VR, the receiving application must use a DICOM data dictionary to look up the format of each data element.

1.8 SYMBOLS AND ABBREVIATIONS

A list of symbols and abbreviations, which is applicable to all GEMS Conformance Statements, is included in the *Introduction to the Integrated DICOM/Network v3.0 (ID/Net v3.0) Conformance Statement, Direction: 2118780*. Additional abbreviations and terms used in this Conformance Statement document are listed below:

<u>TERM</u>	<u>DESCRIPTION</u>
AE	Application Entity
CD-R	Compact Disk Recordable
DVD	Digital Video Disc
CT	Computed Tomography
DICOM	Digital Imaging and Communications in Medicine
FSC	File-Set Creator
FSU	File-Set Updater
FSR	File-Set Reader
IOD	Information Object Definition
ISO	International Organization for Standards
JPEG	Joint Photographic Experts Group
LUT	Look-up Table
MPPS	Modality Performed Procedure Step
MR	Magnetic Resonance Imaging
O	Optional (Key Attribute)
PDU	Protocol Data Unit
R	Required (Key Attribute)
SC	Secondary Capture
SCP	Service Class Provider
SCU	Service Class User
SOP	Service-Object Pair
SR	Structured Reporting
TCP/IP	Transmission Control Protocol/Internet Protocol
U	Unique (Key Attribute)

US	Ultrasound
VR	Value Representation

2. NETWORK CONFORMANCE STATEMENT

2.1 INTRODUCTION

This section of the DICOM Conformance Statement specifies the compliance to DICOM conformance requirements for the relevant Networking features for LOGIQ P6 PRO version R3.x.x. Note that the format of this section strictly follows the format defined in DICOM Standard PS 3.2 (Conformance). Please refer to that part of the standard while reading this section.

LOGIQ P6 PRO is an Ultrasound scanner running on a commercial computer. It allows for the following DICOM functionality:

- Sending and receiving Echo messages to and from DICOM Verification SCP and client.
- Exporting DICOM images and results to a DICOM SCP or saving the DICOM images and results to DICOM media format.
- Browsing and viewing DICOM images on DICOM media format.
- Querying and retrieving DICOM Modality Worklist from a Worklist SCP.
- Sending start and end of examination to a DICOM Modality Performed Procedure Step SCP.
- Sending storage commitment requests (and receiving replies) to a DICOM Storage Commitment SCP.
- Printing images to a DICOM Printer.
- Querying for examinations from a DICOM Query/Retrieve SCP.

2.2 IMPLEMENTATION MODEL

2.2.1 Application Data Flow Diagram

The Basic and Specific Application models for this device are shown in the following illustration:

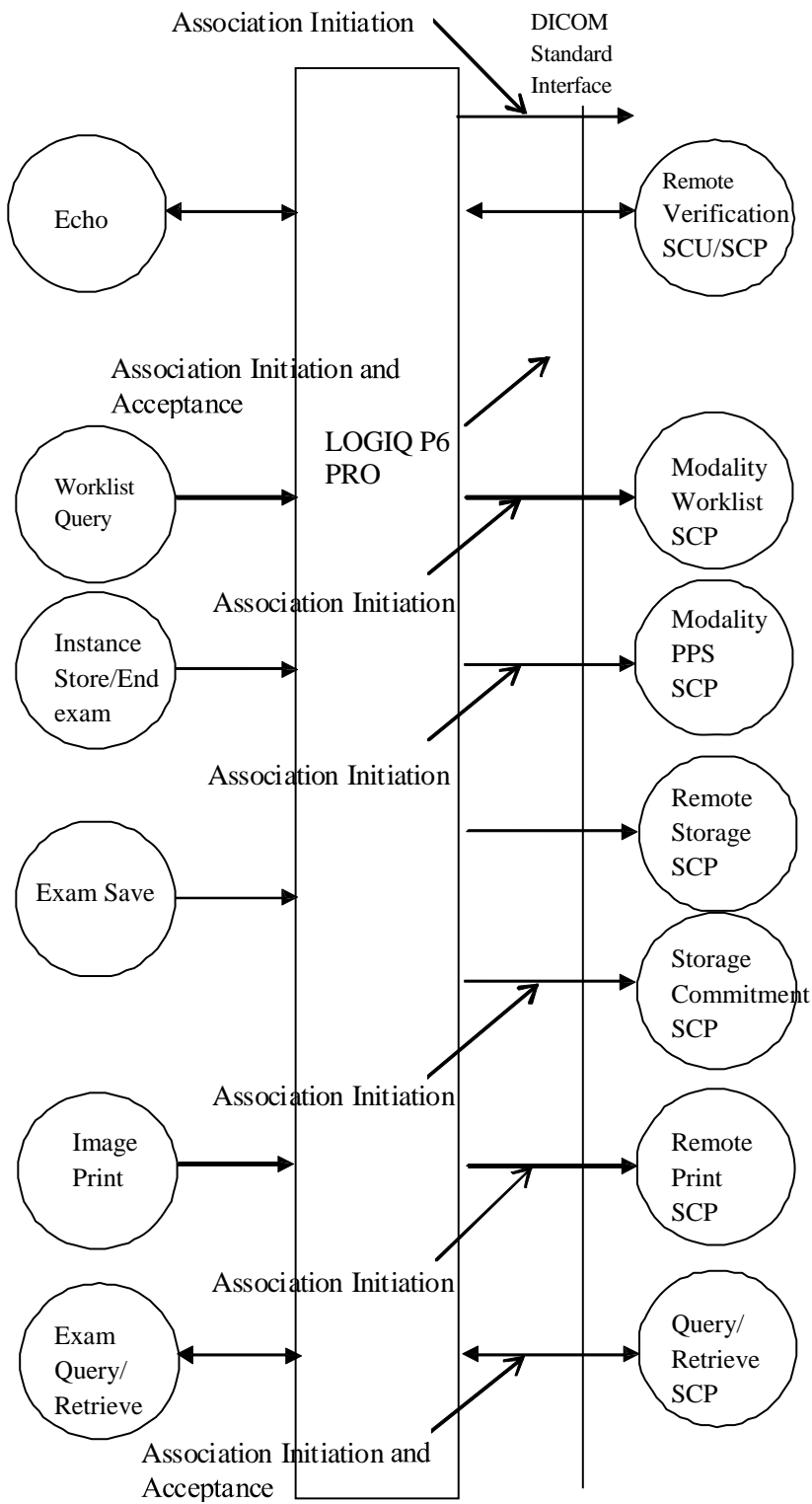

There are six local real-world activities that occur in LOGIQ P6 PRO - **Exam Save, Echo, Worklist Query, Image Store/End Exam, Image Print** and **Exam Query/Retrieve**

Exam save initiates a connection with the DICOM SCP and transmits images and results to the DICOM SCP. If Storage Commitment is configured a commitment request will be sent for the images and results.

Echo initiates a connection with the DICOM SCP, posts a Verification request and closes the connection. It also responds to incoming Verification requests (for service use).

Worklist Query initiates a connection with the DICOM SCP, performs a query and retrieves the matching entries to the product.

Image Store/End exam: If Modality Performed Procedure Step is configured N-CREATE and N-SET messages will be sent for the exam.

Image Print will send images to a DICOM Print SCP.

Exam Query/Retrieve initiates a connection with the DICOM SCP, performs a query and retrieves selected examination.

2.2.2 Functional Definition of AE's

Application Entity LOGIQ P6 PRO supports the following functions:

- Initiates a DICOM association to send images and results.
- Initiates a DICOM verification to assist in network diagnostics.
- Responds to DICOM verification requests from other devices.
- Initiates a DICOM worklist query to receive worklist information.
- Initiates a DICOM association to notify start of examination.
- Initiates a DICOM association to notify end of examination.
- Initiates a DICOM association to request storage commitment of images.
- Responds to replies for storage commitment requests of images.
- Initiates a DICOM association to print images.
- Initiates a DICOM association to query for and retrieve examinations.
- Responds to Image Storage requests from Storage SCU (as part of examination retrieve)

2.2.3 Sequencing of Real-World Activities

Not applicable.

2.3 AE SPECIFICATIONS

2.3.1 LOGIQ P6 PRO AE Specification

This Application Entity provides Standard Conformance to the following DICOM SOP Classes as an SCU:

SOP Class Name	SOP Class UID
Ultrasound Multi-frame Image Storage	1.2.840.10008.5.1.4.1.1.3.1
Ultrasound Multi-frame Image Storage (Retired)	1.2.840.10008.5.1.4.1.1.3
Ultrasound Image Storage	1.2.840.10008.5.1.4.1.1.6.1
Ultrasound Image Storage (Retired)	1.2.840.10008.5.1.4.1.1.6
Secondary Capture Image Storage	1.2.840.10008.5.1.4.1.1.7
Verification SOP Class	1.2.840.10008.1.1
Modality Worklist Information Model – FIND	1.2.840.10008.5.1.4.31
Modality Performed Procedure Step SOP Class	1.2.840.10008.3.1.2.3.3
Storage Commitment Push Model SOP Class	1.2.840.10008.1.20.1
Basic Grayscale Print Management Meta SOP Class	1.2.840.10008.5.1.1.9
Basic Color Print Management Meta SOP Class	1.2.840.10008.5.1.1.18
Study Root Query/Retrieve Information Model – FIND	1.2.840.10008.5.1.4.1.2.2.1
Study Root Query/Retrieve Information Model – MOVE	1.2.840.10008.5.1.4.1.2.2.2
Comprehensive Structured Report Storage	1.2.840.10008.5.1.4.1.1.88.33

This Application Entity provides Standard Conformance to the following DICOM SOP Classes as an SCP:

SOP Class Name	SOP Class UID
Ultrasound Multi-frame Image Storage	1.2.840.10008.5.1.4.1.1.3.1
Ultrasound Multi-frame Image Storage (Retired)	1.2.840.10008.5.1.4.1.1.3
Ultrasound Image Storage	1.2.840.10008.5.1.4.1.1.6.1
Ultrasound Image Storage (Retired)	1.2.840.10008.5.1.4.1.1.6
Secondary Capture Image Storage	1.2.840.10008.5.1.4.1.1.7
Verification SOP Class	1.2.840.10008.1.1

2.3.1.1 LOGIQ P6 PRO AE Specification

2.3.1.1.1 General

The DICOM Application Context Name (ACN), which is always proposed, is:

Application Context Name	1.2.840.10008.3.1.1.1
---------------------------------	------------------------------

The Maximum Length PDU negotiation is included in all association establishment requests. The maximum length PDU for an association initiated by LOGIQ P6 PRO is:

Maximum Length PDU	32768
---------------------------	--------------

The maximum length PDU is a fixed number - not configurable.

The SOP Class Extended Negotiation is not supported.

The user information Items sent by this product are:

- Maximum PDU Length
- Implementation UID
- Implementation Version Name

2.3.1.1.2 Number of Associations and Error Processing

The LOGIQ P6 PRO AE will initiate multiple DICOM associations. The maximum numbers of associations are based on the connectivity service configuration.

The default connection time out value is 30 second. User can configurable this value from 1 to 360 second. There is no response during the time out value, the request service is treated failure and forced to terminate and cancel. This Error processing provide common through the user configuration interface and effect to all requested service. Also, any unknown status values received in response to any request will be treated as failed.

2.3.1.1.3 Asynchronous Nature

Asynchronous mode is not supported. All operations will be performed synchronously.

2.3.1.1.4 Implementation Identifying Information

The Implementation UID for this DICOM Implementation is:

LOGIQ P6 PRO Implementation UID	1.2.840.113619.6.250
--	-----------------------------

The Implementation Version Name for this DICOM Implementation is:

LOGIQ P6 PRO Implementation Version Name	LOGIQP6 PRO-1
---	----------------------

Note: The Implementation Version Name may change in the future without modification of this document.

2.3.1.2 Association Initiation Policy

The LOGIQ P6 PRO AE attempts to establish a new association with a remote device due to six Real-World Activities:

- Exam save initiated by the operator for images and results and sending request for Storage Commitment.
- Verification, which verifies application level communication between peer DICOM AE's for service purposes.
- Worklist initiated by the operator for receiving worklist information.
- Image Store/End Exam sending messages to Modality Performed Procedure Step.
- Print initiated by the operator for a specific image or group of images.
- Exam Query/Retrieve initiated by the operator for receiving examination information and selecting examination to retrieve.

2.3.1.2.1 Real-World Activity A ('Exam save' Operation)

2.3.1.2.1.1 Associated Real-World Activity

Upon a request by the operator (manual or automatic), images will be sent to a DICOM Storage SCP.

2.3.1.2.1.2 Proposed Presentation Context Tables

The Compression is configurable to through the Config screen, see below.

- No Compression.
- JPEG (Lossless or Lossy)
- RLE

The Proposed Presentation Context Table depends on compression according to the following table:

Presentation Context Table – Proposed					
Abstract Syntax		Transfer Syntax		Role	Extended Negotiation
Name	UID	Name List	UID List		
Presentation Context Table: Compression set to None					
Secondary Capture Image Storage	1.2.840.10008.5.1.4.1.1.7	Explicit VR Little Endian Explicit VR Big Endian Implicit VR Little Endian	1.2.840.10008.1.2.1 1.2.840.10008.1.2.2 1.2.840.10008.1.2	SCU	None
Ultrasound Image Storage	1.2.840.10008.5.1.4.1.1.6.1	Explicit VR Little Endian Explicit VR Big Endian Implicit VR Little Endian	1.2.840.10008.1.2.1 1.2.840.10008.1.2.2 1.2.840.10008.1.2	SCU	None
Ultrasound Multi-frame Image Storage	1.2.840.10008.5.1.4.1.1.3.1	Explicit VR Little Endian Explicit VR Big Endian Implicit VR Little Endian	1.2.840.10008.1.2.1 1.2.840.10008.1.2.2 1.2.840.10008.1.2	SCU	None
Ultrasound Image Storage (retired)	1.2.840.10008.5.1.4.1.1.6	Explicit VR Little Endian Explicit VR Big Endian Implicit VR Little Endian	1.2.840.10008.1.2.1 1.2.840.10008.1.2.2 1.2.840.10008.1.2	SCU	None
Ultrasound Multi-frame Image Storage (retired)	1.2.840.10008.5.1.4.1.1.3	Explicit VR Little Endian Explicit VR Big Endian Implicit VR Little Endian	1.2.840.10008.1.2.1 1.2.840.10008.1.2.2 1.2.840.10008.1.2	SCU	None
Presentation Context Table: Compression set to RLE					
Secondary Capture Image Storage	1.2.840.10008.5.1.4.1.1.7	Run Length Encoding, RLE Explicit VR Little Endian Explicit VR Big Endian Implicit VR Little Endian	1.2.840.10008.1.2.5 1.2.840.10008.1.2.1 1.2.840.10008.1.2.2 1.2.840.10008.1.2	SCU	None
Ultrasound Image Storage	1.2.840.10008.5.1.4.1.1.6.1	Run Length Encoding, RLE Explicit VR Little Endian Explicit VR Big Endian Implicit VR Little Endian	1.2.840.10008.1.2.5 1.2.840.10008.1.2.1 1.2.840.10008.1.2.2 1.2.840.10008.1.2	SCU	None
Ultrasound Multi-frame Image Storage	1.2.840.10008.5.1.4.1.1.3.1	Run Length Encoding, RLE Explicit VR Little Endian Explicit VR Big Endian Implicit VR Little Endian	1.2.840.10008.1.2.5 1.2.840.10008.1.2.1 1.2.840.10008.1.2.2 1.2.840.10008.1.2	SCU	None
Ultrasound Image Storage (retired)	1.2.840.10008.5.1.4.1.1.6	Run Length Encoding, RLE Explicit VR Little Endian Explicit VR Big Endian Implicit VR Little Endian	1.2.840.10008.1.2.5 1.2.840.10008.1.2.1 1.2.840.10008.1.2.2 1.2.840.10008.1.2	SCU	None

Ultrasound Multi-frame Image Storage (retired)	1.2.840.10008.5.1.4.1.1.3	Run Length Encoding, RLE Explicit VR Little Endian Explicit VR Big Endian Implicit VR Little Endian	1.2.840.10008.1.2.5 1.2.840.10008.1.2.1 1.2.840.10008.1.2.2 1.2.840.10008.1.2	SCU	None
Presentation Context Table: Compression set to JPEG					
Secondary Capture Image Storage	1.2.840.10008.5.1.4.1.1.7	JPEG Baseline(Lossy) JPEG Lossless Non Hierarchical (Process14) Implicit VR Little Endian	1.2.840.10008.1.2.4.50 1.2.840.10008.1.2.4.70 1.2.840.10008.1.2	SCU	None
Ultrasound Image Storage	1.2.840.10008.5.1.4.1.1.6.1	JPEG Baseline(Lossy) JPEG Lossless Non Hierarchical (Process14) Implicit VR Little Endian	1.2.840.10008.1.2.4.50 1.2.840.10008.1.2.4.70 1.2.840.10008.1.2	SCU	None
Ultrasound Multi-frame Image Storage	1.2.840.10008.5.1.4.1.1.3.1	JPEG Baseline(Lossy) JPEG Lossless Non Hierarchical (Process14) Implicit VR Little Endian	1.2.840.10008.1.2.4.50 1.2.840.10008.1.2.4.70 1.2.840.10008.1.2	SCU	None
Ultrasound Image Storage	1.2.840.10008.5.1.4.1.1.6	JPEG Baseline(Lossy) JPEG Lossless Non Hierarchical (Process14) Implicit VR Little Endian	1.2.840.10008.1.2.4.50 1.2.840.10008.1.2.4.70 1.2.840.10008.1.2	SCU	None
Ultrasound Multi-frame Image Storage (retired)	1.2.840.10008.5.1.4.1.1.3	JPEG Baseline(Lossy) JPEG Lossless Non Hierarchical (Process14) Implicit VR Little Endian	1.2.840.10008.1.2.4.50 1.2.840.10008.1.2.4.70 1.2.840.10008.1.2	SCU	None
Presentation Context Table for Structured Reports					
Comprehensive Structured Report	1.2.840.10008.5.1.4.1.1.88.3 3	Explicit VR Little Endian Explicit VR Big Endian Implicit VR Little Endian	1.2.840.10008.1.2.1 1.2.840.10008.1.2.2 1.2.840.10008.1.2	SCU	None

2.3.1.2.1.2.1 SOP Specific DICOM Conformance Statement for all Storage SOP Classes

This operation also sends a Storage Commitment Request, with the following proposed presentation context. The result from the SCP is expected on another association for the Storage Commitment result.

Presentation Context Table - Proposed					
Abstract Syntax		Transfer Syntax		Role	Extended Negotiation
Name	UID	Name List	UID List		
Storage Commitment Push Model SOP Class	1.2.840.10008.1.20.1	Explicit VR Little Endian Explicit VR Big Endian Implicit VR Little Endian	1.2.840.10008.1.2.1 1.2.840.10008.1.2.2 1.2.840.10008.1.2	SCU	None

For these SOP classes (Storage and Storage Commitment), all status codes with status Refused or Error are treated as failures and terminate the association and operation. On a failure, the request will be put in a holding queue for the user to manually retry the request. All status codes with status Warning or Success are treated as successes.

2.3.1.2.2 Real-World Activity B ('Echo' Operation)

2.3.1.2.2.1 Associated Real-World Activity

The user may initiate a DICOM Verification Request in the Config screen. Associations will be released upon the receipt of each C-ECHO confirmation. In the event that the SCP does not respond, the operation will time out, close the association and inform the user.

2.3.1.2.2.2 Proposed Presentation Context Table

Presentation Context Table – Proposed					
Abstract Syntax		Transfer Syntax		Role	Extended Negotiation
Name	UID	Name List	UID List		

Verification SOP Class	1.2.840.10008.1.1	Explicit VR Little Endian Explicit VR Big Endian Implicit VR Little Endian	1.2.840.10008.1.2.1 1.2.840.10008.1.2.2 1.2.840.10008.1.2	SCU	None
------------------------	-------------------	--	---	-----	------

2.3.1.2.3 Real-World Activity C ('Worklist Query' Operation)

2.3.1.2.3.1 Associated Real-World Activity

The user may initiate a DICOM Worklist Query in Search screen, which will send a C-FIND-RQ to the Worklist SCP. Associations will be released upon the receipt of C-FIND-RSP confirmation.

2.3.1.2.3.2 Proposed Presentation Context Tables

Presentation Context Table – Proposed					
Abstract Syntax		Transfer Syntax		Role	Extended Negotiation
Name	UID	Name List	UID List		
Modality Worklist Information Model - FIND	1.2.840.10008.5.1.4.31	Explicit VR Little Endian Explicit VR Big Endian Implicit VR Little Endian	1.2.840.10008.1.2.1 1.2.840.10008.1.2.2 1.2.840.10008.1.2	SCU	None

2.3.1.2.3.2.1 SOP Specific DICOM Conformance Statement for Worklist SOP Classes

The LOGIQ P6 PRO includes matching keys in the Modality Worklist queries as described in Section 9.5. All status codes with status Refused or Error are treated as failures and terminate the association and operation. On a failure, the user will be informed and the last successful query will be used as Worklist. All status codes with status Warning or Success are treated as successes. In the event of exceed time value while query service, LOGIQ P6 PRO terminate and cancel service automatically.

Service Status	Status Code	Further Meaning	Application Behaviour When receiving Status Codes	Related Fields Processed if received
Refused	A700	Out of resources	Terminate the association and operation	(0000,0902)
	0122	SOP Class not Supported	Terminate the association and operation	(0000,0902)
Failed	A900	Identifier does not match SOP Class	Terminate the association and operation	(0000, 0901) (0000, 0902)
	Cxxx	Unable to process	Terminate the association and operation	(0000,0901) (0000,0902)
Cancel	FE00	Matching terminated due to exceed max retries and timeout.	Terminate the association and operation	(0000, 0901) (0000, 0902)
Success	0000	Matching is complete – No final identifier is supplied		None
Pending	FF00	Matches are continuing – Current Match is supplied and any Optional Keys were supported in the same manner	Receiving process of the matches continues.	Identifier

	FF01	Matches are continuing – Warning that one or more Optional Keys were not supported for existence for this Identifier	Receiving process of the matches continues without any warnings or errors	Identifier
--	------	--	---	------------

2.3.1.2.4 Real-World Activity D (‘Image Store/End exam’ Operation)

2.3.1.2.4.1 Associated Real-World Activity

The Modality Performed Procedure Step messages are sent when the first image is acquired for an exam and when the exam is ended (for the case where there are no images, the N-CREATE is sent when the exam is ended). For an exam with saved images or results, the N-SET will be sent with status COMPLETED. For an exam without saved images or results, LOGIQ P6 PRO check buffer image whether save result status is successful or fail before send N-SET message. The N-SET will be sent with status DISCONTINUED automatically.

2.3.1.2.4.2 Proposed Presentation Context Table

Presentation Context Table – Proposed					
Abstract Syntax		Transfer Syntax		Role	Extended Negotiation
Name	UID	Name List	UID List		
Modality Performed Procedure Step SOP Class	1.2.840.10008.3.1.2.3.3	Explicit VR Little Endian Explicit VR Big Endian Implicit VR Little Endian	1.2.840.10008.1.2.1 1.2.840.10008.1.2.2 1.2.840.10008.1.2	SCU	None

2.3.1.2.4.2.1 SOP Specific DICOM Conformance Statement for Modality Performed Procedure Step Class

LOGIQ P6 PRO includes attributes in the Modality Performed Procedure Step N-CREATE as described in Section 10.2. LOGIQ P6 PRO includes attributes in the Modality Performed Procedure Step N-SET as described in Section 10.2. The mapping from Worklist attributes is described in Section 9.5. LOGIQ P6 PRO sends N-SET after the exam is ended. The N-SET will include all acquired images’ UIDs and the status of COMPLETED or DISCONTINUED. For this SOP class, all status codes with status Refused or Error are treated as failures and terminate the association and operation. All status codes with status Warning or Success are treated as successes.

2.3.1.2.5 Real-World Activity E (‘Image Print’ Operation)

2.3.1.2.5.1 Associated Real-World Activity

Upon a request by the operator, print jobs will be sent to a DICOM Print SCP. If an error occurs during the transmission, the current association is released and a new association initiated. The maximum number of retries is configurable.

2.3.1.2.5.2 Proposed Presentation Context Tables

The following table is used:

Presentation Context Table – Proposed					
Abstract Syntax		Transfer Syntax		Role	Extended Negotiation
Name	UID	Name List	UID List		
Basic Grayscale Print Management Meta SOP Class	1.2.840.10008.5.1.1.9	Explicit VR Little Endian Explicit VR Big Endian Implicit VR Little Endian	1.2.840.10008.1.2.1 1.2.840.10008.1.2.2 1.2.840.10008.1.2	SCU	None
Basic Color Print Management Meta SOP Class	1.2.840.10008.5.1.1.18	Explicit VR Little Endian Explicit VR Big Endian Implicit VR Little Endian	1.2.840.10008.1.2.1 1.2.840.10008.1.2.2 1.2.840.10008.1.2	SCU	None

2.3.1.2.5.2.1 SOP Specific DICOM Conformance Statement for all Print Management SOP Classes

The LOGIQ P6 PRO treats all status codes with status Refused or Error are treated as failures and the spool manager retries the operation. After the configurable number of retries has been exceeded the spooler’s job status is set to FAILED and the print job may be retired manually. Please refer to section 12 Print Management SOP Class Definition for more details about printing implementation.

2.3.1.2.6 Real-World Activity F (‘Exam Query/Retrieve’ Operation)

2.3.1.2.6.1 Associated Real-World Activity

The user may initiate a DICOM Exam Query in Search screen, which will send a C-FIND-RQ to the Query/Retrieve SCP. Associations will be released upon the receipt of C-FIND-RSP confirmation. The user may then select an examination to be retrieved, using the C-MOVE-RQ command to the Query/Retrieve SCP. The result from the SCP is expected on another association for the retrieved examinations.

2.3.1.2.6.2 Proposed Presentation Context Tables

Presentation Context Table – Proposed					
Abstract Syntax		Transfer Syntax		Role	Extended Negotiation
Name	UID	Name List	UID List		
Study Root Query/Retrieve Information Model - FIND	1.2.840.10008.5.1.4.1.2.2.1	Explicit VR Little Endian Explicit VR Big Endian Implicit VR Little Endian	1.2.840.10008.1.2.1 1.2.840.10008.1.2.2 1.2.840.10008.1.2	SCU	None
Study Root Query/Retrieve Information Model – MOVE	1.2.840.10008.5.1.4.1.2.2.2	Explicit VR Little Endian Explicit VR Big Endian Implicit VR Little Endian	1.2.840.10008.1.2.1 1.2.840.10008.1.2.2 1.2.840.10008.1.2	SCU	None

2.3.1.2.6.2.1 SOP Specific DICOM Conformance Statement for Study Root Query/Retrieve Information Model FIND SOP Classes

Only a single information model, Study Root, is supported.

All queries are initiated at the highest level of the information model (the STUDY level), and then for each response received, recursively repeated at the next lower levels (the SERIES and then IMAGE levels).

CANCEL requests can be issued during the queries via graphical user interface.

All status codes with status Refused or Error are treated as failures and terminate the association and operation. All status codes with status Warning or Success are treated as successes.

CANCEL requests can be issued during the queries via graphical user interface. LOGIQ P6 PRO will only support hierarchical query.

2.3.1.2.7 SOP Specific DICOM Conformance Statement for Study Root Query/Retrieve Information Model - MOVE SOP Classes

All status codes with status Refused or Error are treated as failures and terminate the association and operation. All status codes with status Warning or Success are treated as successes.

2.3.1.3 Association Acceptance Policy

The AE accepts an association when LOGIQ P6 PRO receives a Verification Request from another network device or a C-STORE request as part of a Query/Retrieve operation or a Storage Commitment result from a Storage Commitment SCP.

2.3.1.3.1 Real-World Activity B – (‘Echo’ operation)

2.3.1.3.1.1 Associated Real-World Activity

An incoming Verification Request will cause the AE to accept the association and respond with a Verification Response.

2.3.1.3.1.2 Accepted Presentation Context Table

Presentation Context Table - Accepted					
Abstract Syntax		Transfer Syntax		Role	Extended Negotiation
Name	UID	Name List	UID List		
Verification SOP Class	1.2.840.10008.1.1	Explicit VR Little Endian	1.2.840.10008.1.2.1	SCP	None
		Explicit VR Big Endian	1.2.840.10008.1.2.2		
		Implicit VR Little Endian	1.2.840.10008.1.2		

2.3.1.3.1.2.1 SOP Specific DICOM Conformance Statement for Verify SOP Class

The AE provides standard conformance to the Verification SOP Class as an SCP. The port number used is configured on Config screen, default is 104.

2.3.1.3.1.3 Presentation Context Acceptance Criterion

No criterion.

2.3.1.3.1.4 Transfer Syntax Selection Policies

The selected transfer syntax is based on the proposed transfer syntax list. The priority order is Explicit VR Little Endian, Explicit VR Big Endian and Implicit VR Little Endian.

2.3.1.3.2 Real-World Activity F ('Exam Query/Retrieve' Operation)

2.3.1.3.2.1 Associated Real-World Activity

If the user has initiated a retrieve by a C-MOVE-RQ, the AE will accept associations for C-STORE-RQs. The images will be stored locally.

2.3.1.3.2.2 Accepted Presentation Context Table

Presentation Context Table – Accepted					
Abstract Syntax		Transfer Syntax		Role	Extended Negotiation
Name	UID	Name List	UID List		
Ultrasound Image Storage	1.2.840.10008.5.1.4.1.1.6.1	JPEG Baseline (Lossy)	1.2.840.10008.1.2.4.50	SCP	None
		JPEG Lossless Non Hierarchical (Process 14)	1.2.840.10008.1.2.4.70		
		Explicit VR Little Endian	1.2.840.10008.1.2.1		
		Explicit VR Big Endian	1.2.840.10008.1.2.2		
		Implicit VR Little Endian	1.2.840.10008.1.2		
Run Length Encoding, RLE	1.2.840.10008.1.2.5				
Ultrasound Multi-frame Image Storage	1.2.840.10008.5.1.4.1.1.3.1	JPEG Baseline (Lossy)	1.2.840.10008.1.2.4.50	SCP	None
		JPEG Lossless Non Hierarchical (Process 14)	1.2.840.10008.1.2.4.70		
		Explicit VR Little Endian	1.2.840.10008.1.2.1		
		Explicit VR Big Endian	1.2.840.10008.1.2.2		
		Implicit VR Little Endian	1.2.840.10008.1.2		
Run Length Encoding, RLE	1.2.840.10008.1.2.5				

Ultrasound Image Storage (retired)	1.2.840.10008.5.1.4.1.1.6	JPEG Baseline (Lossy) JPEG Lossless Non Hierarchical (Process 14) Explicit VR Little Endian Explicit VR Big Endian Implicit VR Little Endian Run Length Encoding, RLE	1.2.840.10008.1.2.4.50 1.2.840.10008.1.2.4.70 1.2.840.10008.1.2.1 1.2.840.10008.1.2.2 1.2.840.10008.1.2 1.2.840.10008.1.2.5	SCP	None
Ultrasound Multi-frame Image Storage (retired)	1.2.840.10008.5.1.4.1.1.3	JPEG Baseline (Lossy) JPEG Lossless Non Hierarchical (Process 14) Explicit VR Little Endian Explicit VR Big Endian Implicit VR Little Endian Run Length Encoding, RLE	1.2.840.10008.1.2.4.50 1.2.840.10008.1.2.4.70 1.2.840.10008.1.2.1 1.2.840.10008.1.2.2 1.2.840.10008.1.2 1.2.840.10008.1.2.5	SCP	None
Secondary Capture Image Storage	1.2.840.10008.5.1.4.1.1.7	JPEG Baseline (Lossy) JPEG Lossless Non Hierarchical (Process 14) Explicit VR Little Endian Explicit VR Big Endian Implicit VR Little Endian Run Length Encoding, RLE	1.2.840.10008.1.2.4.50 1.2.840.10008.1.2.4.70 1.2.840.10008.1.2.1 1.2.840.10008.1.2.2 1.2.840.10008.1.2 1.2.840.10008.1.2.5	SCP	None

2.3.1.3.2.2.1 SOP Specific DICOM Conformance Statement for Storage SOP Classes

The AE provides standard conformance to the Storage SOP Classes as an SCP. The port number used is configured on Config screen, default is 104. Below are all possible status codes which LOGIQ P6 PRO would send upon storage request.

Service Status	Status Code	Conditions
Failed	Cxxx	Processing Error.
Success	0000	SOP Instance is stored successfully.

2.3.1.3.2.3 Presentation Context Acceptance Criterion

No criterion.

2.3.1.3.2.4 Transfer Syntax Selection Policies

The selected transfer syntax is based on the proposed transfer syntax list. The priority order is JPEG Baseline Explicit VR Little Endian Explicit VR Big Endian Implicit VR Little Endian and Run Length Encoding, RLE.

2.3.1.3.3 Real-World Activity A ('Exam Save' Operation)

2.3.1.3.3.1 Associated Real-World Activity

LOGIQ P6 PRO will only listen for an N-EVENT-REPORT (Storage Commitment Result) from a Storage Commitment SCP in a new association.

2.3.1.3.3.2 Accepted Presentation Context Tables

The Accepted Presentation Context Table is defined according to the following table. The result from the SCP is expected on another association for the Storage Commitment result.

Presentation Context Table - Accepted					
Abstract Syntax		Transfer Syntax		Role	Extended Negotiation
Name	UID	Name List	UID List		
Storage Commitment Push Model SOP Class	1.2.840.10008.1.20.1	Explicit VR Little Endian Explicit VR Big Endian Implicit VR Little Endian	1.2.840.10008.1.2.1 1.2.840.10008.1.2.2 1.2.840.10008.1.2	SCU	None

2.3.1.3.3.2.1 SOP Specific DICOM Conformance Statement for the Storage Commitment Push Model SOP Class SCU

LOGIQ P6 PRO will only accept the SCU role (which must be proposed via SCP/SCU Role Selection Negotiation) within a Presentation Context for the Storage Commitment Push Model SOP Class. The result from the SCP is expected on another association for the Storage Commitment result.

The LOGIQ P6 PRO behavior after receiving an N-EVENT-REPORT (Storage Commitment Result) is described in Section 11.2.4. Below are all possible status codes which LOGIQ P6 PRO would send upon N-EVENT-REPORT request as EVENT-REPORT response. The port number used is configured on Config screen, default is 104.

Service Status	Status Code	Conditions
Failed	0110H	Processing Error
Success	0000	N-Even Report received successfully.

2.4 COMMUNICATION PROFILES

2.4.1 Supported Communication Stacks (PS 3.8)

DICOM Upper Layer (PS 3.8) is supported using TCP/IP.

2.4.2 TCP/IP Stack

The TCP/IP stack is inherited from the product’s operating system. Please refer to product documentation for more information.

2.4.2.1 API

Not applicable to this product.

2.5 EXTENSIONS / SPECIALIZATIONS / PRIVATIZATIONS

If so configured, the product will send ultrasound raw data information in private data elements designated by the Private Creator element:

Element Name	Tag	VR	VM	Description
Private Creator	7FE1,00xx	LO	1	GEMS_Ultrasound_MovieGroup_001

This means that all private tags starting with 7FE1, xx will belong to the GEMS_Ultrasound_MovieGroup_001.

If so configured, the product will send preview image in private data elements designated by the Private Creator element:

Element Name	Tag	VR	VM	Description
Private Creator	6003,00xx	LO	1	GEMS_Ultrasound_ImageGroup_001

This means that all private tags starting with 6003, xx will belong to the GEMS_Ultrasound_ImageGroup_001.

2.6 CONFIGURATION

2.6.1 AE Title/Presentation Address Mapping

The Local AE title is configurable through the Config screen, see below.

2.6.2 Configurable Parameters

Network:

- Local IP address
- Local IP netmask
- Local routing table information

Local:

- Local AE Title

Verification:

- The AE Title, IP address and port number of the SCP
- Max retries, Retry interval, Timeout

Modality Worklist:

- The AE Title, IP address and port number of the SCP
- Max retries, Retry interval, Timeout
- Disabling/enabling and setting constant values for query fields
- Maximum number of downloaded entries

Storage:

- The AE Title, IP address and port number of the SCP
- Max retries, Retry interval, Timeout
- Enable/disable raw data
- Frame rate reduction
- Enable/disable multi-frame
- Compression selections
- Color support
- Association strategies: one association per image or one association per exam
- Include images and/or results.
- Template selection.

Modality Performed Procedure Step:

- The AE Title, IP address and port number of the SCP
- Max retries, Retry interval, Timeout

Storage Commitment:

- The AE Title, IP address and port number of the SCP
- Max retries, Retry interval, Timeout

Print:

- The AE Title, IP address and port number of the SCP
- Max retries, Retry interval, Timeout
- Configuration for each job according to attribute description in Section 12 of this document.

Query/Retrieve:

- The AE Title, IP address and port number of the SCP
- Max retries, Retry interval, Timeout
- Disabling/enabling and setting constant values for query fields

- Maximum number of downloaded entries

2.7 SUPPORT OF EXTENDED CHARACTER SETS

LOGIQ P6 PRO will support the ISO_IR 100 (ISO 8859-1:1987 Latin alphabet N 1. supplementary set) as extended character set. Any incoming SOP instance that is encoded using another extended character set will not be displayed.

2.8 CODES AND CONTROLLED TERMINOLOGY

2.8.1 Fixed Coded Terminology

The product uses the fixed (non-configurable, non-extensible) coded terminology in SR Document attributes, as described in Section 7 SR INFORMATION OBJECT IMPLEMENTATION.

2.9 SECURITY PROFILES

The product does not conform to any defined DICOM Security Profiles.

It is assumed that the product is used within a secured environment. It is assumed that a secured environment includes at a minimum:

1. Firewall or router protections to ensure that only approved external hosts have network access to the product.
2. Firewall or router protections to ensure that the product only has network access to approved external hosts and services.
3. Any communications with external hosts and services outside the locally secured environment use appropriate secure network channels (such as a Virtual Private Network(VPN))

3. MEDIA STORAGE CONFORMANCE STATEMENT

3.1 INTRODUCTION

This section of the conformance statement (CS) specifies the LOGIQ P6 PRO compliance to DICOM Media Interchange. It details the DICOM Media Storage Application Profiles and roles, which are supported by this product. LOGIQ P6 PRO is able to export images and results to DICOM media, browse DICOM media or read images from DICOM media.

3.2 IMPLEMENTATION MODEL

3.2.1 Application Data Flow Diagram

The Basic and Specific Application models for this device are shown in the following Illustration:

ILLUSTRATION 3-1
SPECIFIC AE APPLICATION MODEL

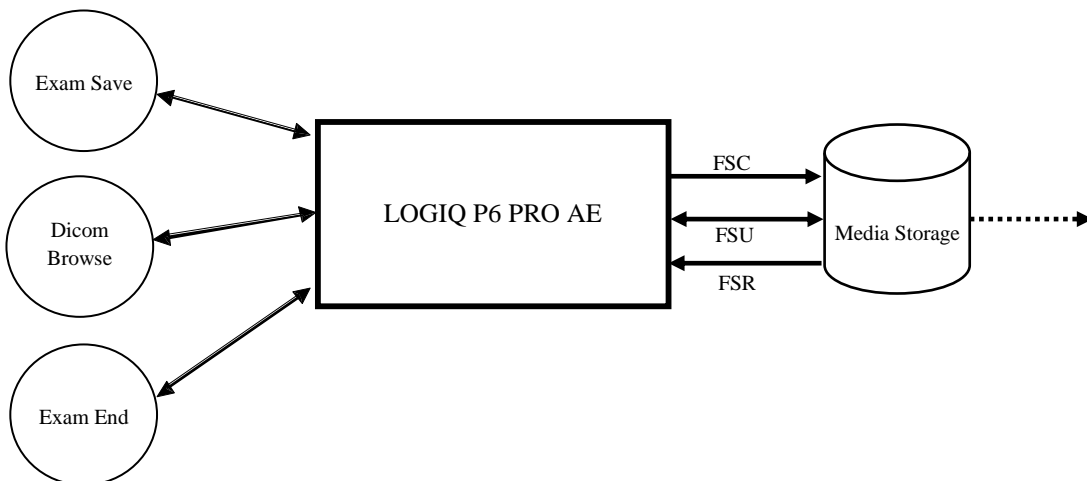

LOGIQ P6 PRO can initialize Media by acting as an FSC to create a new DICOM File-set on CD/DVD media of various sizes (includes CDs labeled 650MB, 700MB and DVD-R media labeled 4.7GB). The SOP instances written to media must be one of the instances supported by LOGIQ P6 PRO. A pre-existing File-set will updated with the information in DICOM latest files copied to media.

3.2.2 Functional Definition of AE's

LOGIQ P6 PRO can perform these functions:

- Create a new DICOM File-set on media
- Update DICOM File-set by adding new SOP instances to the File-set
- Read information and images from the existing File-set

3.2.3 Sequencing Requirements

None applicable

3.2.4 File Meta Information Options (See PS3.10)

The File Meta-Information for this implementation is:

File Meta-Information Version	1
LOGIQ P6 PRO Implementation UID	1.2.840.113619.6.250
Implementation Version Name	LOGIQ P6 PRO-1

Note: The Implementation Version Name and may change in the future without modification of this document.

3.3 AE SPECIFICATIONS

3.3.1 LOGIQ P6 PRO AE Specification

The LOGIQ P6 PRO Application Entity provides standard conformance to DICOM Interchange Option of the Media Storage Service Class. The Application Profiles and roles are listed below, the standard profiles are augmented with Secondary Capture images and SRs. Note that in one case (see 4.5.7.1 US Region Calibration Module), the multi-frame image will be sent without region calibration (i.e. AUG-US-ID-MF-XXX).

Supported Application Profile	Real World Activity	Role	Description
AUG-US-SC-SF-CDR, AUG-US-SC-MF-CDR,	Exam save	FSC/ FSU	Interchange
	Browse	FSR	Interchange
	Exam Read	FSR	Interchange
AUG-US-SC-SF-DVD, AUG-US-SC-MF-DVD	Exam save	FSC	Interchange
	Browse	FSR	Interchange
	Exam Read	FSR	Interchange
STD-US-SC-SF-CDR STD-US-SC-SF-DVD	Browse	FSR	Interchange

3.3.1.1 File Meta Information for the LOGIQ P6 PRO Application Entity

The Source Application Entity is set from the LOGIQ P6 PRO local AE title. Following are the default value set in the File Meta Information for this AE Title:

Source Application Entity Title	LOGIQ P6 PRO-1(User Configurable)
--	--

3.3.1.2 Real-World Activities for the LOGIQ P6 PRO Application Entity

3.3.1.2.1 Real-World Activity “Exam save”

“Exam saves” saves a DICOM SOP instance to media and updates DICOM File Set.

3.3.1.2.1.1 Media Storage Application Profile for the Real-World Activity “Exam save”:

For the list of Application Profiles that invoke this AE for “Exam save” Real-World Activity, see the Table in Section 3.3.1 “LOGIQ P6 PRO AE Specification” where the table describing the profiles and real-world activities is defined.

3.3.1.2.1.1.1 Options

Following are the SOP Classes supported by the Real-World Activity “Exam save”:

Information Object Definition	SOP Class UID	Transfer Syntax	Transfer Syntax UID
DICOM Media Storage Directory	1.2.840.10008.1.3.10	Explicit VR Little Endian	1.2.840.10008.1.2.1
Ultrasound Multi-frame Image Storage	1.2.840.10008.5.1.4.1.1.3.1	Explicit VR Little Endian	1.2.840.10008.1.2.1
		Run Length Encoding, RLE	1.2.840.10008.1.2.5
		JPEG Baseline	1.2.840.10008.1.2.4.50
Ultrasound Image Storage	1.2.840.10008.5.1.4.1.1.6.1	Explicit VR Little Endian	1.2.840.10008.1.2.1
		Run Length Encoding, RLE	1.2.840.10008.1.2.5
		JPEG Baseline	1.2.840.10008.1.2.4.50
Secondary Capture Image Storage	1.2.840.10008.5.1.4.1.1.7	Explicit VR Little Endian	1.2.840.10008.1.2.1
		Run Length Encoding, RLE	1.2.840.10008.1.2.5
		JPEG Baseline	1.2.840.10008.1.2.4.50
Comprehensive Structured Report	1.2.840.10008.5.1.4.1.1.88.33	Explicit VR Little Endian	1.2.840.10008.1.2.1

3.3.1.2.2 Real-World Activity “DICOM Browse”

DICOM Browse is activated when the user searches for an exam in Search screen.

3.3.1.2.2.1 Media Storage Application Profile for the Real-World Activity “DICOM Browse”

For the list of Application Profiles that invoke this AE for Image Read Real-World Activity, see the Table in Section 3.2.1 “LOGIQ P6 PRO AE Specification”.

3.3.1.2.2.1.1 Options

Following are the SOP Classes supported by the Real-World Activity DICOM Browse:

Information Object Definition	SOP Class UID	Transfer Syntax	Transfer Syntax UID
DICOM Media Storage Directory	1.2.840.10008.1.3.10	Explicit VR Little Endian	1.2.840.10008.1.2.1
Ultrasound Multi-frame Image Storage	1.2.840.10008.5.1.4.1.1.3.1	Explicit VR Little Endian	1.2.840.10008.1.2.1
		Explicit VR Big Endian	1.2.840.10008.1.2.2
		Implicit VR Little Endian	1.2.840.10008.1.2
		Run Length Encoding, RLE	1.2.840.10008.1.2.5
		JPEG Baseline	1.2.840.10008.1.2.4.50
		JPEG Lossless Non Hierarchical (Process 14)	1.2.840.10008.1.2.4.70
Ultrasound Multi-frame Image Storage(retired)	1.2.840.10008.5.1.4.1.1.3	Explicit VR Little Endian	1.2.840.10008.1.2.1
		Explicit VR Big Endian	1.2.840.10008.1.2.2
		Implicit VR Little Endian	1.2.840.10008.1.2

		Run Length Encoding, RLE	1.2.840.10008.1.2.5
		JPEG Baseline	1.2.840.10008.1.2.4.50
		JPEG Lossless Non Hierarchical (Process 14)	1.2.840.10008.1.2.4.70
Ultrasound Image Storage	1.2.840.10008.5.1.4.1.1.6.1	Explicit VR Little Endian	1.2.840.10008.1.2.1
		Explicit VR Big Endian	1.2.840.10008.1.2.2
		Implicit VR Little Endian	1.2.840.10008.1.2
		Run Length Encoding, RLE	1.2.840.10008.1.2.5
		JPEG Baseline	1.2.840.10008.1.2.4.50
		JPEG Lossless Non Hierarchical (Process 14)	1.2.840.10008.1.2.4.70
Ultrasound Image Storage (retired)	1.2.840.10008.5.1.4.1.1.6	Explicit VR Little Endian	1.2.840.10008.1.2.1
		Explicit VR Big Endian	1.2.840.10008.1.2.2
		Implicit VR Little Endian	1.2.840.10008.1.2
		Run Length Encoding, RLE	1.2.840.10008.1.2.5
		JPEG Baseline	1.2.840.10008.1.2.4.50
		JPEG Lossless Non Hierarchical (Process 14)	1.2.840.10008.1.2.4.70
Secondary Capture Image Storage	1.2.840.10008.5.1.4.1.1.7	Explicit VR Little Endian	1.2.840.10008.1.2.1
		Explicit VR Big Endian	1.2.840.10008.1.2.2
		Implicit VR Little Endian	1.2.840.10008.1.2
		Run Length Encoding, RLE	1.2.840.10008.1.2.5
		JPEG Baseline	1.2.840.10008.1.2.4.50
		JPEG Lossless Non Hierarchical (Process 14)	1.2.840.10008.1.2.4.70

3.3.1.2.3 Real-World Activity “Exam read“

“Exam read” reads and displays a DICOM SOP instance from media.

3.3.1.2.3.1 Media Storage Application Profile for the Real-World Activity “Exam read “

For the list of Application Profiles that invoke this AE for Exam read Real-World Activity, see the Table in Section 3.2.1 “LOGIQ P6 PRO AE Specification”.

3.3.1.2.3.1.1 Options

Following are the SOP Classes supported by the Exam read Real-World Activity:

Information Object Definition	SOP Class UID	Transfer Syntax	Transfer Syntax UID
--------------------------------------	----------------------	------------------------	----------------------------

DICOM Media Storage Directory	1.2.840.10008.1.3.10	Explicit VR Little Endian	1.2.840.10008.1.2.1
Ultrasound Multi-frame Image Storage	1.2.840.10008.5.1.4.1.1.3.1	Explicit VR Little Endian	1.2.840.10008.1.2.1
		Explicit VR Big Endian	1.2.840.10008.1.2.2
		Implicit VR Little Endian	1.2.840.10008.1.2
		Run Length Encoding, RLE	1.2.840.10008.1.2.5
		JPEG Baseline	1.2.840.10008.1.2.4.50
		JPEG Lossless Non Hierarchical (Process 14)	1.2.840.10008.1.2.4.70
Ultrasound Multi-frame Image Storage(retired)	1.2.840.10008.5.1.4.1.1.3	Explicit VR Little Endian	1.2.840.10008.1.2.1
		Explicit VR Big Endian	1.2.840.10008.1.2.2
		Implicit VR Little Endian	1.2.840.10008.1.2
		Run Length Encoding, RLE	1.2.840.10008.1.2.5
		JPEG Baseline	1.2.840.10008.1.2.4.50
		JPEG Lossless Non Hierarchical (Process 14)	1.2.840.10008.1.2.4.70
Ultrasound Image Storage	1.2.840.10008.5.1.4.1.1.6.1	Explicit VR Little Endian	1.2.840.10008.1.2.1
		Explicit VR Big Endian	1.2.840.10008.1.2.2
		Implicit VR Little Endian	1.2.840.10008.1.2
		Run Length Encoding, RLE	1.2.840.10008.1.2.5
		JPEG Baseline	1.2.840.10008.1.2.4.50
		JPEG Lossless Non Hierarchical (Process 14)	1.2.840.10008.1.2.4.70
Ultrasound Image Storage (retired)	1.2.840.10008.5.1.4.1.1.6	Explicit VR Little Endian	1.2.840.10008.1.2.1
		Explicit VR Big Endian	1.2.840.10008.1.2.2
		Implicit VR Little Endian	1.2.840.10008.1.2
		Run Length Encoding, RLE	1.2.840.10008.1.2.5
		JPEG Baseline	1.2.840.10008.1.2.4.50
		JPEG Lossless Non Hierarchical (Process 14)	1.2.840.10008.1.2.4.70
Secondary Capture Image Storage	1.2.840.10008.5.1.4.1.1.7	Explicit VR Little Endian	1.2.840.10008.1.2.1

		Explicit VR Big Endian	1.2.840.10008.1.2.2
		Implicit VR Little Endian	1.2.840.10008.1.2
		Run Length Encoding, RLE	1.2.840.10008.1.2.5
		JPEG Baseline	1.2.840.10008.1.2.4.50
		JPEG Lossless Non Hierarchical (Process 14)	1.2.840.10008.1.2.4.70

3.4 AUGMENTED AND PRIVATE APPLICATION PROFILES

LOGIQ P6 PRO creates Secondary Capture Image Objects in addition to the objects defined in the application profiles.

3.5 EXTENSIONS, SPECIALIZATIONS, PRIVATIZATIONS OF SOP CLASSES AND TRANSFER SYNTAXES

The detail standard elements are described in section 8.4 for Information Module Definitions. And also LOGIQ P6 PRO provides private data elements for raw data and preview image. See the Section 8.5 for Private data dictionary.

3.6 CONFIGURATION

Not Applicable

3.7 SUPPORT OF EXTENDED CHARACTER SETS

LOGIQ P6 PRO will support only the ISO_IR 100 (ISO 8859-1:1987 Latin alphabet N 1. supplementary set) as extended character sets. Any incoming SOP instance that is encoded using another extended character set will not be read.

4. ULTRASOUND (US) INFORMATION OBJECT IMPLEMENTATION

4.1 INTRODUCTION

This section specifies the use of the DICOM US Image IOD to represent the information included in US images produced by this implementation. Corresponding attributes are conveyed using the module construct. The contents of this section are:

4.2 - IOD Implementation

4.3 - IOD Entity-Relationship Model

4.4 - IOD Module Table

4.5 - IOD Module Definition

In this section, supported means that tag is sent with value.

4.2 US IOD IMPLEMENTATION

This section defines the implementation of US image information object.

4.3 US ENTITY-RELATIONSHIP MODEL

The Entity-Relationship diagram for the US Image interoperability schema is shown in Illustration 4.3-1. In this figure, the following diagrammatic convention is established to represent the information organization:

- each entity is represented by a rectangular box
- each relationship is represented by a diamond shaped box.
- the fact that a relationship exists between two entities is depicted by lines connecting the corresponding entity boxes to the relationship boxes.

The relationships are fully defined with the maximum number of possible entities in the relationship shown. In other words, the relationship between Series and Image can have up to n Images per Series, but the Patient to Study relationship has 1 Patient for each Study (a Patient can have more than one Study on the system, however each Study will contain all of the information pertaining to that Patient).

ILLUSTRATION 4.3-1
US IMAGE ENTITY RELATIONSHIP DIAGRAM

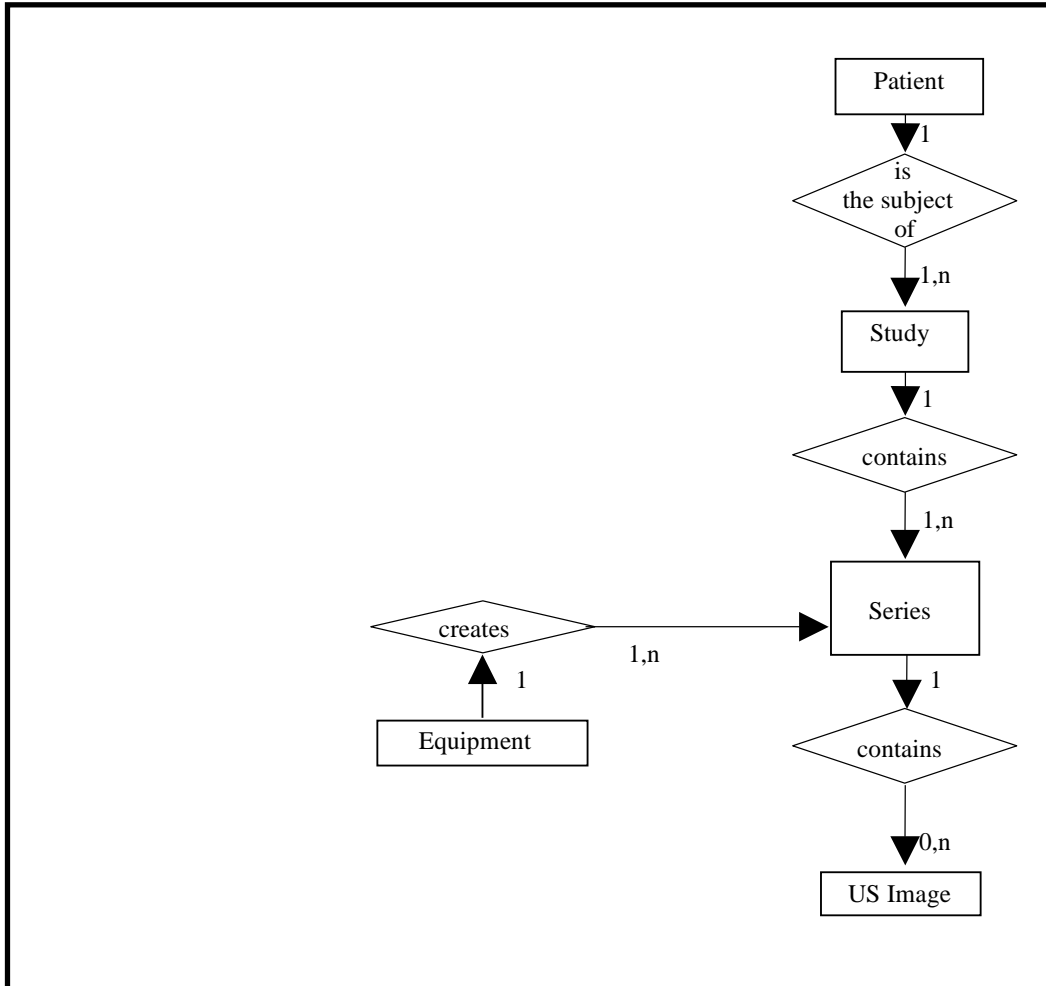

4.3.1 Entity Descriptions

Please refer to DICOM Standard Part 3 (Information Object Definitions) for a description of each of the entities contained within the US Information Object.

4.3.2 LOGIQ P6 PRO Mapping of DICOM Entities

TABLE 4.3-1
MAPPING OF DICOM ENTITIES TO LOGIQ P6 PRO ENTITIES

DICOM	LOGIQ P6 Entity
Patient	Patient
Study	Exam
Series	Exam
Image	Image
Curve	Not used

4.4 IOD MODULE TABLE

Within an entity of the DICOM US IOD, attributes are grouped into related set of attributes. A set of related attributes is termed a module. A module facilitates the understanding of the semantics concerning the attributes and how the attributes are related with each other. A module grouping does not infer any encoding of information into data sets.

Table 4.4-1 identifies the defined modules within the entities, which comprise the DICOM US IOD. Modules are identified by Module Name and Modules not described are not used.

See DICOM Part 3 for a complete definition of the entities, modules, and attributes. Only the single frame US Image IOD is described here.

TABLE 4.4-1
US IMAGE IOD MODULES

Entity Name	Module Name	Reference
Patient	Patient	4.5.1.1
Study	General Study	4.5.2.1
	Patient Study	4.5.2.2
Series	General Series	4.5.3.1
Frame of Reference	Frame of Reference	Not used
Equipment	General Equipment	4.5.4.1
Image	General Image	4.5.5.1
	Image Pixel	4.5.5.2
	Contrast/Bolus	4.5.5.3
	Palette Color Lookup Table	4.5.5.4
	US Region Calibration	4.5.7.1
	US Image	4.5.7.2
	VOI LUT	4.5.5.5
SOP Common	4.5.6.1	

4.5 INFORMATION MODULE DEFINITIONS

Please refer to DICOM Standard Part 3 (Information Object Definitions) for a description of each of the entities and modules contained within the US Information Object.

The following modules are included to convey Enumerated Values, Defined Terms, and Optional Attributes supported. Type 1 & Type 2 Attributes are also included for completeness and to define what values they may take and where these values are obtained. It should be noted that they are the same ones as defined in the DICOM Standard Part 3 (Information Object Definitions). Not described tag is not used and out of scope in LOGIQ P6 PRO.

4.5.1 Common Patient Entity Modules

4.5.1.1 Patient Module

This section specifies the Attributes of the Patient that describe and identify the Patient who is the subject of a diagnostic Study. This Module contains Attributes of the patient that are needed for diagnostic interpretation of the Image and are common for all studies performed on the patient.

**TABLE 4.5-1
PATIENT MODULE ATTRIBUTES**

Attribute Name	Tag	Type	Attribute Description
Patient's Name	(0010,0010)	2	May be entered from User Interface. Taken from worklist if it is there.
Patient ID	(0010,0020)	2	May be entered from User Interface. Taken from worklist if it is there.
Patient's Birth Date	(0010,0030)	2	May be entered from User Interface. Taken from worklist if it is there.
Patient's Sex	(0010,0040)	2	May be entered from User Interface. Taken from worklist if it is there.
Referenced Patient Sequence	(0008,1120)	3	Taken from worklist if it is there. (Not used in SR Documents.)
>Referenced SOP Class UID	(0008,1150)	1C	Taken from worklist if it is there. (Not used in SR Documents.)
>Referenced SOP Instance UID	(0008,1155)	1C	Taken from worklist if it is there. (Not used in SR Documents.)
Patient's Birth Time	(0010,0032)	3	Taken from worklist if it is there.
Other Patient Ids	(0010,1000)	3	Taken from worklist if it is there.
Other Patient Names	(0010,1001)	3	Not used
Issuer of Patient Identifier	(0010,0021)	3	Taken from worklist if it is there.
Other Patient IDs Sequence	(0010,1002)	3	Not used
Ethnic Group	(0010,2160)	3	Taken from worklist if it is there.
Patient Comments	(0010,4000)	3	Taken from worklist if it is there.

4.5.2 Common Study Entity Modules

The following Study IE Modules are common to all Composite Image IODs, which reference the Study IE. These modules contain Attributes of the patient and study that are needed for diagnostic interpretation of the image.

4.5.2.1 General Study Module

This section specifies the attributes that describe and identify the Study performed upon the Patient.

**TABLE 4.5-2
GENERAL STUDY MODULE ATTRIBUTES**

Attribute Name	Tag	Type	Attribute Description
Study Instance UID	(0020,000D)	1	Uniquely generated by the equipment. Taken from worklist if it is there.
Study Date	(0008,0020)	2	Is set to examination date
Study Time	(0008,0030)	2	Is set to examination time
Referring Physician's Name	(0008,0090)	2	May be entered from User Interface. Taken from worklist if it is there.
Study ID	(0020,0010)	2	May be entered from User Interface. Taken from worklist if it is there (from Requested Procedure Id)
Accession Number	(0008,0050)	2	May be entered from User Interface. Taken from worklist if it is there.
Study Description	(0008,1030)	3	Taken from worklist if it is there (from Requested Procedure Description).
Physician(s) of Record	(0008,1048)	3	Taken from worklist if it is there (from Names of Intended Recipients of Result)
Name of Physician(s) Reading Study	(0008,1060)	3	Not used

Attribute Name	Tag	Type	Attribute Description
Referenced Study Sequence	(0008,1110)	3	Taken from worklist if it is there. (Not used in SR Documents.)
>Referenced SOP Class UID	(0008,1150)	1C	Taken from worklist if it is there. (Not used in SR Documents.)
>Referenced SOP Instance UID	(0008,1155)	1C	Taken from worklist if it is there. (Not used in SR Documents.)

4.5.2.2 Patient Study Module

This section defines attributes that provide information about the Patient at the time that the Study was performed.

**TABLE 4.5-3
PATIENT STUDY MODULE ATTRIBUTES**

Attribute Name	Tag	Type	Attribute Description
Admitting Diagnoses Description	(0008,1080)	3	Not used
Patient's Age	(0010,1010)	3	Not used
Patient's Size	(0010,1020)	3	May be entered from User Interface. Taken from worklist if it is there.
Patient's Weight	(0010,1030)	3	May be entered from User Interface. Taken from worklist if it is there.
Occupation	(0010,2180)	3	Not used
Additional Patient's History	(0010,21B0)	3	May be entered from User Interface (in Referral reason). Taken from worklist if it is there.

4.5.3 Common Series Entity Modules

The following Series IE Modules are common to all Composite Image IODs, which reference the Series IE.

4.5.3.1 General Series Module

This section specifies the attributes that identify and describe general information about the Series within a Study.

**TABLE 4.5-4
GENERAL SERIES MODULE ATTRIBUTES**

Attribute Name	Tag	Type	Attribute Description
Modality	(0008,0060)	1	Defined Term "US" used. When reading SC all modalities are accepted.
Series Instance UID	(0020,000E)	1	Uniquely generated by the equipment
Series Number	(0020,0011)	2	Internal number which is incremented for each new series within a study.
Laterality	(0020,0060)	2C	Not used
Series Date	(0008,0021)	3	Is set to Series date
Series Time	(0008,0031)	3	Is set to Series time
Performing Physicians' Name	(0008,1050)	3	May be entered from User Interface. Taken from worklist if it is there (from Scheduled Performing Physician's Name)
Protocol Name	(0018,1030)	3	Sent if image is acquired in a stress test.
Series Description	(0008,103E)	3	May be entered from User Interface (in Diagnosis).
Operator's Name	(0008,1070)	3	May be entered from User Interface. Default is login id.
Referenced Performed Procedure Step Sequence	(0008,1111)	3	Used if Modality Performed Procedure Step is enabled.
>Referenced SOP Class UID	(0008,1150)	1C	Used if Modality Performed Procedure Step is enabled.

Attribute Name	Tag	Type	Attribute Description
>Referenced SOP Instance UID	(0008,1155)	1C	Used if Modality Performed Procedure Step is enabled.
Body Part Examined	(0018,0015)	3	Not used
Patient Position	(0018,5100)	2C	Not used
Smallest Pixel Value in Series	(0028,0108)	3	Not used
Largest Pixel Value in Series	(0028,0109)	3	Not used
Request Attributes Sequence	(0040,0275)	3	Used if Modality Worklist and/or Modality Performed Procedure Step is enabled.
>Requested Procedure ID	(0040,1001)	1C	Taken from worklist if it is there.
>Scheduled Procedure Step ID	(0040,0009)	1C	Taken from worklist if it is there.
>Scheduled Procedure Step Description	(0040,0007)	3	Taken from worklist if it is there.
>Scheduled Protocol Code Sequence	(0040,0008)	3	Taken from worklist if it is there.
>>Include 'Code Sequence Macro'			
Performed Procedure Step ID	(0040,0253)	3	Used if Modality Performed Procedure Step is enabled.
Performed Procedure Step Start Date	(0040,0244)	3	Used if Modality Performed Procedure Step is enabled.
Performed Procedure Step Start Time	(0040,0245)	3	Used if Modality Performed Procedure Step is enabled.
Performed Procedure Step Description	(0040,0254)	3	Used if Modality Performed Procedure Step is enabled.
Performed Protocol Code Sequence	(0040,0260)	3	Taken from worklist if it is there (from Scheduled Protocol Code Sequence)

4.5.4 Common Equipment Entity Modules

The following Equipment IE Module is common to all Composite Image IODs, which reference the Equipment IE.

4.5.4.1 General Equipment Module

This section specifies the attributes that identify and describe the piece of equipment, which produced a Series of Images.

TABLE 4.5-5
GENERAL EQUIPMENT MODULE ATTRIBUTES

Attribute Name	Tag	Type	Attribute Description
Manufacturer	(0008,0070)	2	Is set to "GE Healthcare"
Institution Name	(0008,0080)	3	Is set to configured Institution Name.
Institution Address	(0008,0081)	3	Not used
Station Name	(0008,1010)	3	Is set to configured Station Name.
Institutional Department Name	(0008,1040)	3	May be entered from User Interface. Default is configured Department name.
Manufacturer's Model Name	(0008,1090)	3	Is set to "LOGIQ P6 PRO".
Device Serial Number	(0018,1000)	3	Not used
Software Versions	(0018,1020)	3	Is set to LOGIQ P6 PRO: R3.x.x software version
Spatial Resolution	(0018,1050)	3	Not used
Date of Last Calibration	(0018,1200)	3	Not used
Time of Last Calibration	(0018,1201)	3	Not used
Pixel Padding Value	(0028,0120)	3	Not used

4.5.5 Common Image Entity Modules

The following Image IE Modules are common to all Composite Image IODs, which reference the Image IE.

4.5.5.1 General Image Module

This section specifies the attributes that identify and describe an image within a particular series.

TABLE 4.5-6
GENERAL IMAGE MODULE ATTRIBUTES

Attribute Name	Tag	Type	Attribute Description
Instance Number	(0020,0013)	2	Internal value which is incremented for each image within a series
Patient Orientation	(0020,0020)	2C	Sent with empty value.
Content Date	(0008,0023)	2C	Set from Image date
Content Time	(0008,0033)	2C	Set from Image time
Image Type	(0008,0008)	3	The first two values contain "ORIGINAL\ PRIMARY" or "DERIVED\ PRIMARY". Value 3 is the description of the type of application per the DICOM PS3.3-2008, section C.8.5.6.1.1 Value 4 is the description of the type of application per the DICOM PS3.3-2008, section C.8.5.6.1.1 Values 5 and 6 may be used for private data. See the Image Type in Table 4.5-13
Acquisition Number	(0020,0012)	3	Not used
Acquisition Date	(0008,0022)	3	Not used
Acquisition Time	(0008,0032)	3	Not used
Acquisition Datetime	(0008,002A)	3	Supported
Referenced Image Sequence	(0008,1140)	3	Not used
>Referenced SOP Class UID	(0008,1150)	1C	Not used
>Referenced SOP Instance UID	(0008,1155)	1C	Not used
>Referenced Frame Number	(0008,1160)	3	Not used
Derivation Description	(0008,2111)	3	May contain additional derivation information if Image Type is DERIVED.
Source Image Sequence	(0008,2112)	3	Not used
>Referenced SOP Class UID	(0008,1150)	1C	Not used
>Referenced SOP Instance UID	(0008,1155)	1C	Not used
>Referenced Frame Number	(0008,1160)	3	Not used
Images in Acquisition	(0020,1002)	3	Not used
Image Comments	(0020,4000)	3	May be used for description of the image
Quality Control Image	(0028,0300)	3	Not used
Burned In Annotation	(0028,0301)	3	Not used
Lossy Image Compression	(0028,2110)	3	Set to 01 if images is lossy compressed.
Lossy Image Compression Ratio	(0028,2112)	3	Used if lossy compressed.

4.5.5.2 Image Pixel Module

This section specified the attributes that describe the pixel data of the image.

TABLE 4.5-7
IMAGE PIXEL MODULE ATTRIBUTES

Attribute Name	Tag	Type	Attribute Description
Samples per Pixel	(0028,0002)	1	Value of '1' if Photometric Interpretation element value has value 'MONOCHROME2', 'PALETTE COLOR' Value of '3' when Photometric Interpretation element value has value 'RGB', 'YBR_FULL' or 'YBR_FULL_422'
Photometric Interpretation	(0028,0004)	1	Defined Values used: 'MONOCHROME2',

Attribute Name	Tag	Type	Attribute Description
			'PALETTE COLOR', 'RGB', 'YBR_FULL' or 'YBR_FULL_422'
Rows	(0028,0010)	1	Value depends on scanning mode and configuration setup
Columns	(0028,0011)	1	Value depends on scanning mode and configuration setup.
Bits Allocated	(0028,0100)	1	Value always = 0008H.
Bits Stored	(0028,0101)	1	Value always = 0008H.
High Bit	(0028,0102)	1	Value always = 0007H.
Pixel Representation	(0028,0103)	1	Defined Value '0' - unsigned integer.
Pixel Data	(7FE0,0010)	1	Pixel Data of image.
Planar Configuration	(0028,0006)	1C	Enumerated value 0000H, color-by-pixel, if Photometric Interpretation element value has value 'RGB' or if image is JPEG compressed or if image is uncompressed. Enumerated value 0001H, color-by-plane if image is RLE compressed.
Pixel Aspect Ratio	(0028,0034)	1C	Not used
Smallest Image Pixel Value	(0028,0106)	3	Not used
Largest Image Pixel Value	(0028,0107)	3	Not used
Red Palette Color Lookup Table Descriptor	(0028,1101)	1C	Not used
Green Palette Color Lookup Table Descriptor	(0028,1102)	1C	Not used
Blue Palette Color Lookup Table Descriptor	(0028,1103)	1C	Not used
Red Palette Color Lookup Table Data	(0028,1201)	1C	Not used
Green Palette Color Lookup Table Data	(0028,1202)	1C	Not used
Blue Palette Color Lookup Table Data	(0028,1203)	1C	Not used

4.5.5.3 Contrast/Bolus Module

This section specifies the attributes that describe the contrast /bolus used in the acquisition of the Image. Contrast Agent won't be sent if no Contrast Agent was used to acquire images.

**TABLE 4.5-8
CONTRAST/BOLUS MODULE ATTRIBUTES**

Attribute Name	Tag	Type	Attribute Description
Red Palette Color Lookup Table Descriptor	(0028,1101)	1C	Only used when reading Palette images.
Green Palette Color Lookup Table Descriptor	(0028,1102)	1C	Only used when reading Palette images.
Blue Palette Color Lookup Table Descriptor	(0028,1103)	1C	Only used when reading Palette images.
Palette Color Lookup Table UID	(0028,1199)	3	Not used
Red Palette Color Lookup Table Data	(0028,1201)	1C	Only used when reading Palette images.
Green Palette Color Lookup Table Data	(0028,1202)	1C	Only used when reading Palette images.
Blue Palette Color Lookup Table Data	(0028,1203)	1C	Only used when reading Palette images.
Segmented Red Palette Color Lookup Table Data	(0028,1221)	1C	Not used
Segmented Green Palette Color Lookup Table Data	(0028,1222)	1C	Not used
Segmented Red Palette Color Lookup Table Data	(0028,1223)	1C	Not used

4.5.5.4 Palette Color Lookup Table Module

This section specifies the attributes that describe the Lookup table data for images with Palette Color photometric

interpretation.

**TABLE 4.5-9
PALETTE COLOR LOOKUP MODULE**

Attribute Name	Tag	Type	Attribute Description
Red Palette Color Lookup Table Descriptor	(0028,1101)	1C	Only used when reading Palette images.
Green Palette Color Lookup Table Descriptor	(0028,1102)	1C	Only used when reading Palette images.
Blue Palette Color Lookup Table Descriptor	(0028,1103)	1C	Only used when reading Palette images.
Palette Color Lookup Table UID	(0028,1199)	3	Not used
Red Palette Color Lookup Table Data	(0028,1201)	1C	Only used when reading Palette images.
Green Palette Color Lookup Table Data	(0028,1202)	1C	Only used when reading Palette images.
Blue Palette Color Lookup Table Data	(0028,1203)	1C	Only used when reading Palette images.
Segmented Red Palette Color Lookup Table Data	(0028,1221)	1C	Not used
Segmented Green Palette Color Lookup Table Data	(0028,1222)	1C	Not used
Segmented Red Palette Color Lookup Table Data	(0028,1223)	1C	Not used

4.5.5.5 VOI LUT Module

This section specifies the attributes that identify and describe the VOI LUT Module. VOI LUT Module only sent if acquired image is Grayscale mode.

**TABLE 4.5-10
VOI LUT MODULE ATTRIBUTES**

Attribute Name	Tag	Type	Attribute Description
VOI LUT Sequence	(0028,3010)	3	Not used
>LUT Descriptor	(0028,3002)	3	Not used
>LUT Explanation	(0028,3003)	3	Not used
>LUT Data	(0028,3006)	3	Not used
Window Center	(0028,1050)	3	Value set to 127 if Photometric Interpretation has value MONOCHROME2.
Window Width	(0028,1051)	3	Value set to 256 if Photometric Interpretation has value MONOCHROME2.
Window Center & Width Explanation	(0028,1055)	3	Not used

4.5.6 General Modules

The SOP Common Module is mandatory for all DICOM IODs.

4.5.6.1 SOP Common Module

This section defines the attributes that are required for proper functioning and identification of the associated SOP Instances. They do not specify any semantics about the Real-World Object represented by the IOD.

**TABLE 4.5-11
SOP COMMON MODULE ATTRIBUTES**

Attribute Name	Tag	Type	Attribute Description
SOP Class UID	(0008,0016)	1	Set to "1.2.840.10008.5.1.4.1.1.3.1" "1.2.840.10008.5.1.4.1.1.3" "1.2.840.10008.5.1.4.1.1.6.1" "1.2.840.10008.5.1.4.1.1.6" "1.2.840.10008.5.1.4.1.1.7" or "1.2.840.10008.5.1.4.1.1.88.33"

Attribute Name	Tag	Type	Attribute Description
SOP Instance UID	(0008,0018)	1	Uniquely generated by the equipment
Specific Character Set	(0008,0005)	1 C	Set to "ISO_IR 100" if extended characters are used. Image Read: images using other extended character set than "ISO_IR 100" are rejected.
Instance Creation Date	(0008,0012)	3	Not used
Instance Creation Time	(0008,0013)	3	Not used
Instance Creator UID	(0008,0014)	3	Not used
Instance Number	(0020,0013)	3	Not used

4.5.7 US Modules

This Section describes US Series, Equipment, and Image Modules. These Modules contain attributes that are specific to US Image IOD.

4.5.7.1 US Region Calibration Module

US Region Calibration Module is used to describe multiple regions. Note: if a multi-frame image has been acquired with different calibration, the US Region Calibration Module will not be used.

TABLE 4.5-12
US REGION CALIBRATION MODULE ATTRIBUTES

Attribute Name	Tag	Type	Attribute Description
Sequence of Ultrasound Regions	(0018,6011)	1	
>Region Location Min x_0	(0018,6018)	1	Value is 0
>Region Location Min y_0	(0018,601A)	1	Value is 0
>Region Location Max x_1	(0018,601C)	1	Value is image width-1.
>Region Location Max y_1	(0018,601E)	1	Value is image height-1
>Physical Units X Direction	(0018,6024)	1	Enumerated Values supported: 0003H cm 0004H seconds
>Physical Units Y Direction	(0018,6026)	1	Enumerated Values supported: 0003H cm 0004H seconds 0007H cm/sec
>Physical Delta X	(0018,602C)	1	Varies with scanning mode
>Physical Delta Y	(0018,602E)	1	Varies with scanning mode
>Reference Pixel x_0	(0018,6020)	3	Varies with scanning mode
>Reference Pixel y_0	(0018,6022)	3	Varies with scanning mode
>Ref. Pixel Physical Value X	(0018,6028)	3	Varies with scanning mode
>Ref. Pixel Physical Value Y	(0018,602A)	3	Varies with scanning mode
>Region Spatial Format	(0018,6012)	1	Supported. The spatial organization of the data within the region. 0000H None or not applicable 0001H 2D(tissue or flow) 0002H M-Mode(tissue or flow) 0003H Spectral(CW or PW Doppler) 0004H Wave form(physiological traces, doppler traces,...) 0005H Graphics
>Region Data Type	(0018,6014)	1	Supported. The type of data within the region. See PS3.-2008. section C8.5.5.1.2 for Enumerated

Attribute Name	Tag	Type	Attribute Description
			Values.
>Region Flags	(0018,6016)	1	Bit 0: 0 = Opaque Bit 1: 0 = Not Protected because there may be other regions within the image Bit 2: 0 = Velocity
>Pixel Component Organization	(0018,6044)	1C	Pixel component calibration data does not exist for any region
>Pixel Component Mask	(0018,6046)	1C	Not used
>Pixel Component Range Start	(0018,6048)	1C	Not used
>Pixel Component Range Stop	(0018,604A)	1C	Not used
>Pixel Component Physical Units	(0018,604C)	1C	Not used
>Pixel Component Data Type	(0018,604E)	1C	Not used
>Number of Table Break Points	(0018,6050)	1C	Not used
>Table of X Break Points	(0018,6052)	1C	Not used
>Table of Y Break Points	(0018,6054)	1C	Not used
>Number of Table Entries	(0018,6056)	1C	Not used
>Table of Pixel Values	(0018,6058)	1C	Not used
>Table of Parameter Values	(0018,605A)	1C	Not used
>Transducer Frequency	(0018,6030)	3	Supported
>Pulse Repetition Frequency	(0018,6032)	3	Supported
>Doppler Correction Angle	(0018,6034)	3	Not used
>Steering Angle	(0018,6036)	3	Not used
>Doppler Sample Volume X Position	(0018,6038)	3	Not used
>Doppler Sample Volume Y Position	(0018,603A)	3	Not used
>TM-Line Position x_0	(0018,603C)	3	Not used
>TM-Line Position y_0	(0018,603E)	3	Not used
>TM-Line Position x_1	(0018,6040)	3	Not used
>TM-Line Position y_1	(0018,6042)	3	Not used

4.5.7.2 US Image Module

This section specifies the attributes that describe ultrasound images

TABLE 4.5-13
US IMAGE MODULE ATTRIBUTES

Attribute Name	Tag	Type	Attribute Description
Samples Per Pixel	(0028,0002)	1	Value of '1' if Photometric Interpretation element value has value 'MONOCHROME2', 'PALETTE COLOR' Value of '3' when Photometric Interpretation element value has value 'RGB' or 'YBR_FULL' or 'YBR_FULL_422'
Photometric Interpretation	(0028,0004)	1	Defined Values used: 'MONOCHROME2', 'PALETTE COLOR', 'RGB', 'YBR_FULL' or 'YBR_FULL_422'
Bits Allocated	(0028,0100)	1	Value always = 0008H
Bits Stored	(0028,0101)	1	Value always = 0008H
High Bit	(0028,0102)	1	Value always = 0007H

Attribute Name	Tag	Type	Attribute Description
Planar Configuration	(0028,0006)	1	Enumerated value 0000H, color-by-pixel, if Photometric Interpretation element value has value 'RGB' or if image is JPEG compressed or if image is uncompressed. Enumerated value 0001H, color-by-plane if image is RLE compressed.
Pixel Representation	(0028,0103)	1	Always 0000H = unsigned integer.
Frame Increment Pointer	(0028,0009)	1C	Export: Is set to Frame Time (0018,1063) or Frame Time Vector (0018,1065) if the image is multiframe IOD, Not used if the image is a single frame IOD.
Image Type	(0008,0008)	2	The first two values contain "ORIGINAL/PRIMARY" or "DERIVED/ PRIMARY". Value 3 and 4 are the description of the type of application per the DICOM PS3.3-2008, section C.8.5.6.1.1 ABDOMINAL GYNECOLOGY OBSTETRICAL PEDIATRIC SMALL PARTS VASCULAR SCROTAL INTRACARDIAC Value 4 is the description of the type of application per the DICOM PS3.3-2008, section C.8.5.6.1.1 0001 2D Imaging 0002 M- Mode 0004 CW Doppler 0008 PW Doppler 0010 Color Doppler 0020 Color M-Mode 0040 3D Rendering 0100 Color Power Mode Values 5 and 6 may be used for private data.
Number of Stages	(0008,2124)	2C	Number of stages in stress protocol. Sent if image is acquired in a stress test.
Lossy Image Compression	(0028,2110)	1C	Set to 01 if image is compressed using JPEG Baseline compression.
Number of Views in Stage	(0008,212A)	2C	Number of views in this stage of a stress protocol. Sent if image is acquired in a stress test.
Ultrasound Color Data Present	(0028,0014)	3	Supported
Stage Name	(0008,2120)	3	Name of stage of stress test. Sent if image is acquired in a stress test. The name is defined in the User Interface.
Stage Number	(0008,2122)	3	Number of stage, starting at one. Sent if image is acquired in a stress test.
View Name	(0008,2127)	3	Name of view of stress test. Sent if image is acquired in a stress test. The name is defined in the User Interface.
View Number	(0008,2128)	3	Number of view, starting at one. Sent if image is acquired in a stress test.
Number of Event Timers	(0008,2129)	3	Not used
Event Elapsed Time(s)	(0008,2130)	3	Not used
Event Timer Name(s)	(0008,2132)	3	Not used
Anatomic Region Sequence	(0008,2218)	3	Not used
>Include 'Code Sequence Macro'			
>Anatomic Region Modifier Sequence	(0008,2220)	3	Not used
>>Include 'Code Sequence Macro'			
Primary Anatomic Structure Sequence	(0008,2228)	3	Not used
>Include 'Code Sequence Macro'			

Attribute Name	Tag	Type	Attribute Description
>Primary Anatomic Structure Modifier Sequence	(0008,2230)	3	Not used
>>Include 'Code Sequence Macro'			
Trigger Time	(0018,1060)	3	Not used
Nominal Interval	(0018,1062)	3	Not used
Beat Rejection Flag	(0018,1080)	3	Not used
Low R-R Value	(0018,1081)	3	Not used
High R-R Value	(0018,1082)	3	Not used
Heart Rate	(0018,1088)	3	Set to heart rate
Output Power	(0018,5000)	3	Not used
Transducer Data	(0018,5010)	3	Not used
Transducer Type	(0018,6031)	3	Not used
Focus Depth	(0018,5012)	3	Not used
Preprocessing Function	(0018,5020)	3	Not used
Mechanical Index	(0018,5022)	3	Not used
Bone Thermal Index,	(0018,5024)	3	Not used
Cranial Thermal Index	(0018,5026)	3	Not used
Soft Tissue Thermal Index	(0018,5027)	3	Not used
Soft Tissue-focus Thermal Index	(0018,5028)	3	Not used
Soft Tissue-surface Thermal Index	(0018,5029)	3	Not used
Depth of Scan Field	(0018,5050)	3	Not used
Image Transformation Matrix	(0018,5210)	3	Not used
Image Translation Vector	(0018,5212)	3	Not used
Overlay Subtype	(60xx,0045)	3	Not used

5. ULTRASOUND MULTIFRAME (US MF) INFORMATION OBJECT IMPLEMENTATION

5.1 INTRODUCTION

This section specifies the use of the DICOM US Multi-frame Image IOD to represent the information included in US images produced by this implementation. Corresponding attributes are conveyed using the module construct. The contents of this section are:

5.2 - IOD Implementation

5.3 - IOD Entity-Relationship Model

5.4 - IOD Module Table

5.5 - IOD Module Definition

5.2 US MF IOD IMPLEMENTATION

This section defines the implementation of US Multi-Frame image information object.

5.3 US MF ENTITY-RELATIONSHIP MODEL

The Entity-Relationship diagram for the US MF Image interoperability schema is shown in Illustration 5.3-1. In this figure, the following diagrammatic convention is established to represent the information organization:

- each entity is represented by a rectangular box
- each relationship is represented by a diamond shaped box.
- the fact that a relationship exists between two entities is depicted by lines connecting the corresponding entity boxes to the relationship boxes.

The relationships are fully defined with the maximum number of possible entities in the relationship shown. In other words, the relationship between Series and Image can have up to n Images per Series, but the Patient to Study relationship has 1 Patient for each Study (a Patient can have more than one Study on the system, however each Study will contain all of the information pertaining to that Patient).

ILLUSTRATION 5.3-1
US MULTIFRAME IMAGE ENTITY RELATIONSHIP DIAGRAM

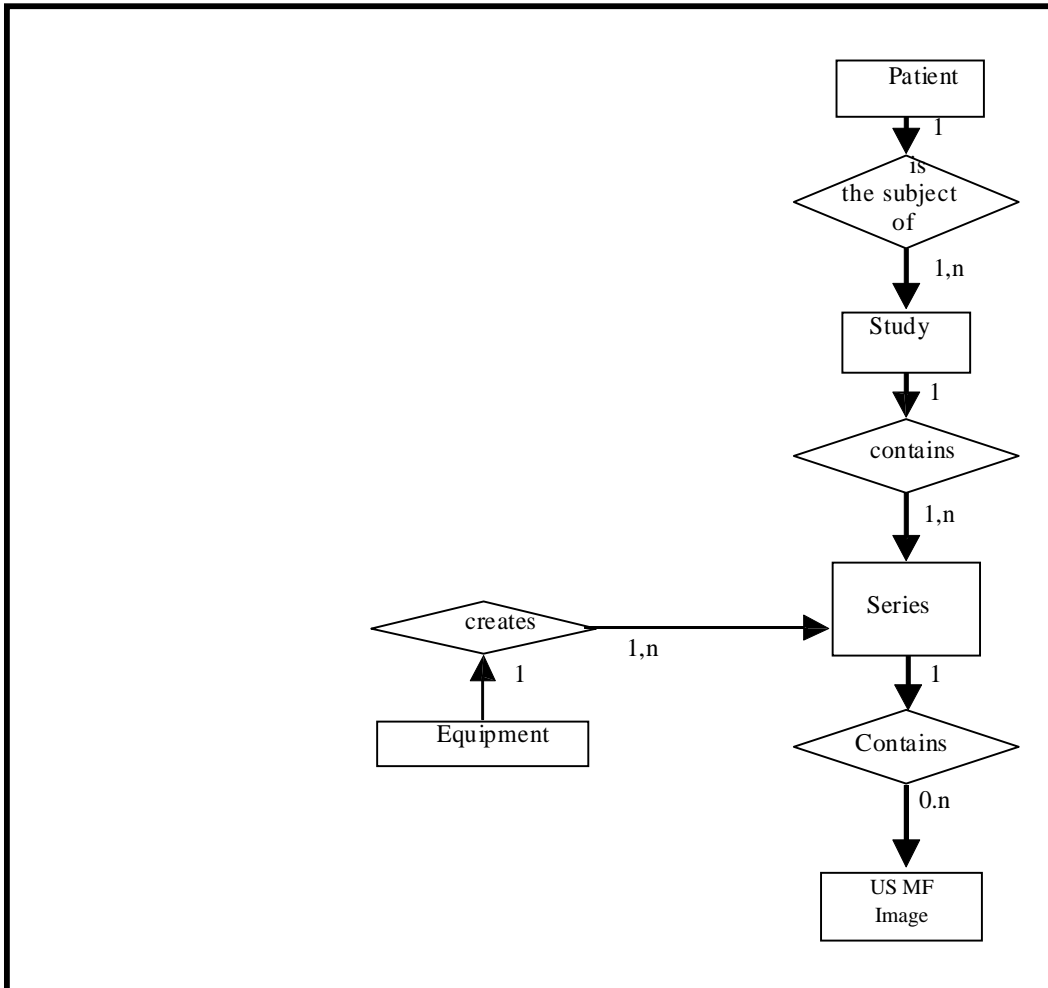

5.3.1 Entity Descriptions

Please refer to DICOM Standard Part 3 (Information Object Definitions) for a description of each of the entities contained within the US Multi-Frame Information Object.

5.3.2 LOGIQ P6 PRO Mapping of DICOM entities

TABLE 5.3-1
MAPPING OF DICOM ENTITIES TO LOGIQ P6 PRO ENTITIES

DICOM	LOGIQ P6 PRO Entity
Patient	Patient
Study	Exam
Series	Exam
Image	Image
Curve	Not used

5.4 IOD MODULE TABLE

Within an entity of the DICOM US Multi-Frame IOD, attributes are grouped into related set of attributes. A set of related attributes is termed a module. A module facilitates the understanding of the semantics concerning the attributes and how the attributes are related with each other. A module grouping does not infer any encoding of information into datasets.

Table 5.4-1 identifies the defined modules within the entities, which comprise the DICOM US Multi- Frame IOD. Modules are identified by Module Name and Modules not described are not used.

See DICOM Part 3 for a complete definition of the entities, modules, and attributes.

TABLE 5.4-1
US MULTI-FRAME IOD MODULES

Entity Name	Module Name	Reference
Patient	Patient	4.5.1.1
Study	General Study	4.5.2.1
	Patient Study	4.5.2.2
Series	General Series	4.5.3.1
Equipment	General Equipment	4.5.4.1
Image	General Image	4.5.5.1
	Image Pixel	4.5.5.2
	Contrast/Bolus	4.5.5.3
	Cine	5.5.1.1
	Multi-frame	5.5.1.2
	Palette Color Lookup Table	4.5.5.4
	US Region Calibration	4.5.7.1
	US Image	4.5.7.2
	VOI LUT	4.5.5.5
	SOP Common	4.5.6.1

5.5 INFORMATION MODULE DEFINITIONS

Please refer to DICOM Standard Part 3 (Information Object Definitions) for a description of each of the entities and modules contained within the US Multi-Frame Information Object.

The following modules are included to convey Enumerated Values, Defined Terms, and Optional Attributes supported. Type 1 & Type 2 Attributes are also included for completeness and to define what values they may take and where these values are obtained. It should be noted that they are the same ones as defined in the DICOM Standard Part 3 (Information Object Definitions).

5.5.1 Common Image Modules

The following Image IE Modules are common to all Composite Image IODs which reference the Image IE.

5.5.1.1 Cine Module

TABLE 5.5-2
CINE MODULE ATTRIBUTES

Attribute Name	Tag	Type	Attribute Description
Frame Time	(0018,1063)	1C	Is set to the interframe time
Frame Time Vector	(0018,1065)	1C	Supported. Reading: Average value is set to interframe time
Start Trim	(0008,2142)	3	Supported
Stop Trim	(0008,2143)	3	Supported
Recommended Display Frame Rate	(0008,2144)	3	Supported
Cine Rate	(0018,0040)	3	Supported
Frame Delay	(0018,1066)	3	Supported
Effective Duration	(0018,0072)	3	Supported
Actual Frame Duration	(0018,1242)	3	Supported
Preferred Playback Sequencing	(0018,1244)	3	Supported

5.5.1.2 Multi-frame Module

TABLE 5.5-3
MULTI-FRAME MODULE ATTRIBUTES

Attribute Name	Tag	Type	Attribute Description
Number of Frames	(0028,0008)	1	Is set to the number of frames in image
Frame Increment Pointer	(0028,0009)	1	Is set to Frame Time (0018,1063) or Frame Time Vector (0018,1065)

6. SC INFORMATION OBJECT IMPLEMENTATION

6.1 INTRODUCTION

This section specifies the use of the DICOM SC Image IOD to represent the information included in SC images produced by this implementation. Corresponding attributes are conveyed using the module construct. The contents of this section are:

6.2 - IOD Implementation

6.3 - IOD Entity-Relationship Model

6.4 - IOD Module Table

6.5 - IOD Module Definition

6.2 SC IOD IMPLEMENTATION

This section defines the implementation of SC image information object.

6.3 SC ENTITY-RELATIONSHIP MODEL

The Entity-Relationship diagram for the SC Image interoperability schema is shown in Illustration 6.3-1. In this figure, the following diagrammatic convention is established to represent the information organization:

- each entity is represented by a rectangular box
- each relationship is represented by a diamond shaped box.
- the fact that a relationship exists between two entities is depicted by lines connecting the corresponding entity boxes to the relationship boxes.

The relationships are fully defined with the maximum number of possible entities in the relationship shown. In other words, the relationship between Series and Image can have up to n Images per Series, but the Patient to Study relationship has 1 Patient for each Study (a Patient can have more than one Study on the system, however each Study will contain all of the information pertaining to that Patient).

ILLUSTRATION 6.3-1
US MULTIFRAME IMAGE ENTITY RELATIONSHIP DIAGRAM

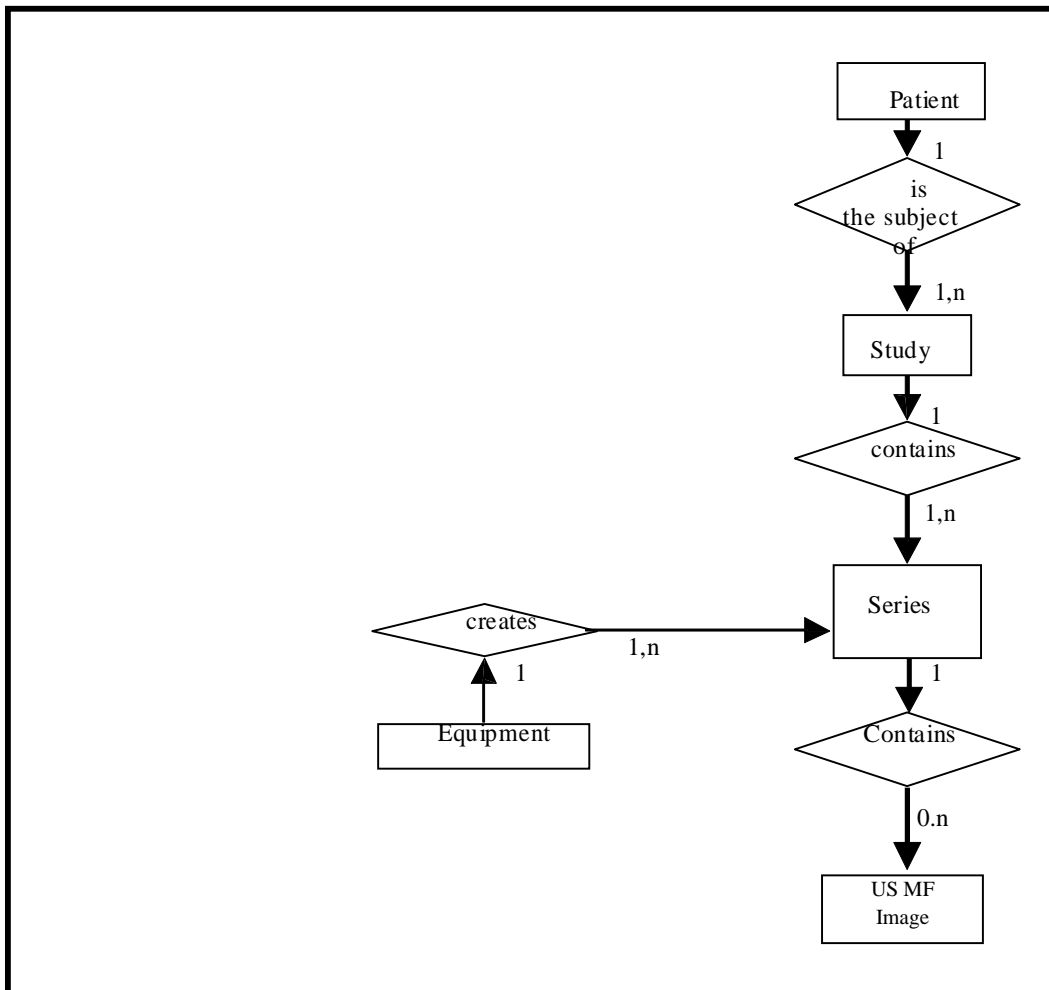

6.3.1 Entity Descriptions

Please refer to DICOM Standard Part 3 (Information Object Definitions) for a description of each of the entities contained within the SC Information Object.

6.3.2 LOGIQ P6 PRO Mapping of DICOM Entities

TABLE 6.3-1
MAPPING OF DICOM ENTITIES TO LOGIQ P6 PRO ENTITIES

DICOM	LOGIQ P6 PRO Entity
Patient	Patient
Study	Exam
Series	Exam
Image	Image
Frame	Not Applicable

6.4 IOD MODULE TABLE

Within an entity of the DICOM SC IOD, attributes are grouped into related set of attributes. A set of related attributes is termed a module. A module facilitates the understanding of the semantics concerning the attributes and how the attributes are related with each other. A module grouping does not infer any encoding of information into datasets.

Table 6.4-1 identifies the defined modules within the entities, which comprise the DICOM SC IOD. Modules are identified by Module Name and Modules not described are not used.

See DICOM Part 3 for a complete definition of the entities, modules, and attributes.

TABLE 6.4-1
SC IMAGE IOD MODULES

Entity Name	Module Name	Reference
Patient	Patient	4.5.1.1
Study	General Study	4.5.2.1
	Patient Study	4.5.2.2
Series	General Series	4.5.3.1
Equipment	General Equipment	4.5.4.1
	SC Equipment	6.5.1.1
Image	General Image	4.5.5.1
	Image Pixel	4.5.5.2
	SC Image	6.5.1.2
	VOI LUT	4.5.5.5
	SOP Common	4.5.6.1

6.5 INFORMATION MODULE DEFINITIONS

Please refer to DICOM Standard Part 3 (Information Object Definitions) for a description of each of the entities and modules contained within the SC Information Object.

The following modules are included to convey Enumerated Values, Defined Terms, and Optional Attributes supported. Type 1 & Type 2 Attributes are also included for completeness and to define what values they may take and where these values are obtained. It should be noted that they are the same ones as defined in the DICOM Standard Part 3 (Information Object Definitions).

6.5.1 SC Modules

This Section describes SC Equipment, and Image Modules. These Modules contain attributes that are specific to SC Image IOD.

6.5.1.1 SC Equipment Module

This Module describes equipment used to convert images into a DICOM format.

TABLE 6.5-2
SC IMAGE EQUIPMENT MODULE ATTRIBUTES

Attribute Name	Tag	Type	Attribute Description
Conversion Type	(0008,0064)	1	Set to WSD

Modality	(0008,0060)	3	Defined Value "US" used. When reading SC all modalities are accepted
Secondary Capture Device ID	(0018,1010)	3	Defined Value "LOGIQ P6 PRO"
Secondary Capture Device Manufacturer	(0018,1016)	3	Implementation defined string "GE Healthcare"
Secondary Capture Device Manufacturer's Model Name	(0018,1018)	3	Implementation defined string "LOGIQ P6 PRO"
Secondary Capture Device Software Version	(0018,1019)	3	Is set to LOGIQ P6 PRO:R3.x.x software
Video Image Format Acquired	(0018,1022)	3	Not used
Digital Image Format Acquired	(0018,1023)	3	Not used

6.5.1.2 SC Image Module

The table in this Section contains IOD attributes that describe SC images

TABLE 6.5-3
SC IMAGE MODULE ATTRIBUTES

Attribute Name	Tag	Type	Attribute Description
Date of Secondary Capture	(0018,1012)	3	Image capture date
Time of Secondary Capture	(0018,1014)	3	Image capture time

7. SR INFORMATION OBJECT IMPLEMENTATION

7.1 INTRODUCTION

This section specifies the use of the DICOM Comprehensive SR IOD to represent results produced by this implementation. Corresponding attributes are conveyed using the module construct. The contents of this section are:

7.2- IOD Implementation

7.3 - IOD Entity-Relationship Model

7.4 - IOD Module Table

7.5 - IOD Module Definition

In this section, supported means that tag is sent with value.

7.2 COMPREHENSIVE SR IOD IMPLEMENTATION

This section defines the implementation of Comprehensive SR information object.

7.3 COMPREHENSIVE SR ENTITY-RELATIONSHIP MODEL

The Entity-Relationship diagram for the Comprehensive SR interoperability schema is shown in Illustration 7.3-1. In this figure, the following diagrammatic convention is established to represent the information organization:

- each entity is represented by a rectangular box
- each relationship is represented by a diamond shaped box.
- the fact that a relationship exists between two entities is depicted by lines connecting the corresponding entity boxes to the relationship boxes.

The relationships are fully defined with the maximum number of possible entities in the relationship shown. In other words, the relationship between Series and SR Documents can have up to n SR Documents per Series, but the Patient to Study relationship has 1 Patient for each Study (a Patient can have more than one Study on the system, however each Study will contain all of the information pertaining to that Patient).

**ILLUSTRATION 7.3-1
COMPREHENSIVE SR ENTITY RELATIONSHIP DIAGRAM**

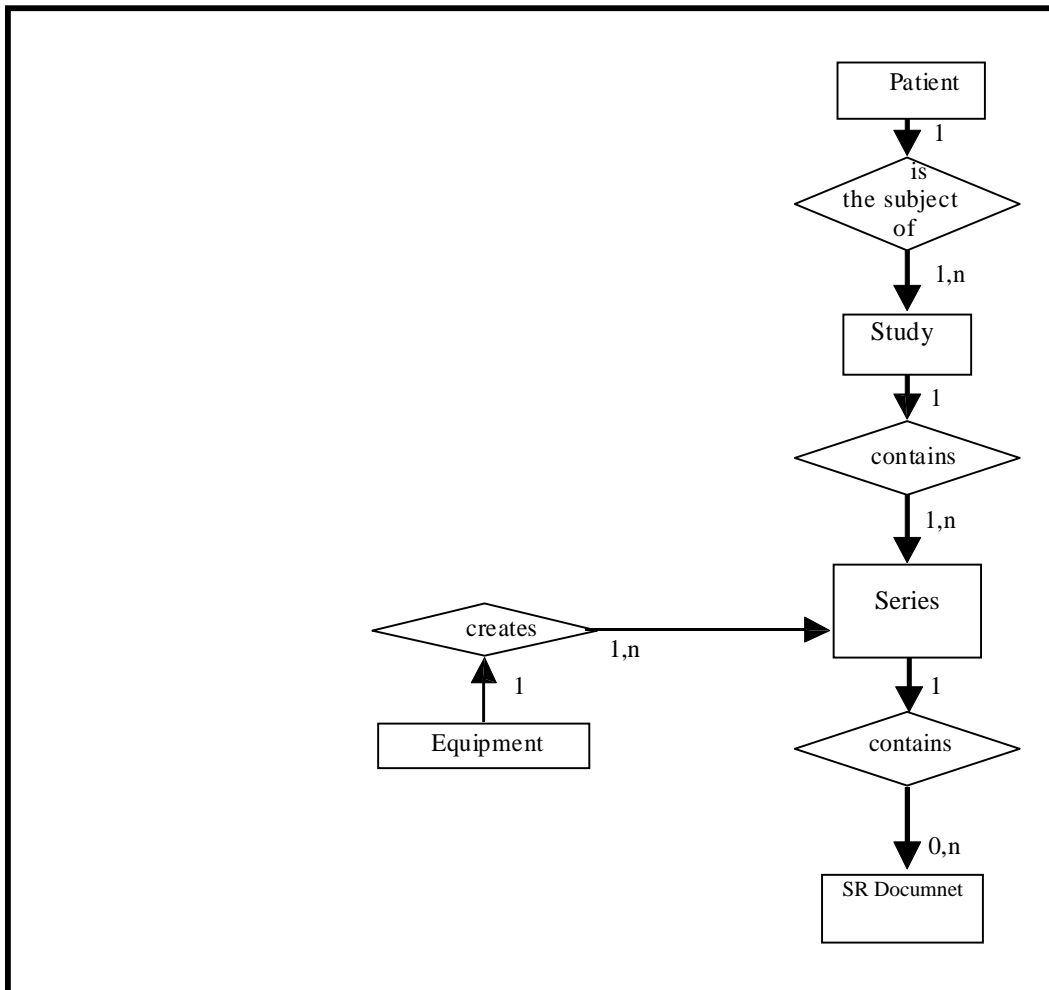

7.3.1 Entity Descriptions

Please refer to DICOM Standard Part 3 (Information Object Definitions) for a description of each of the entities contained within the Comprehensive SR Information Object.

7.3.2 LOGIQ P6 PRO Mapping of DICOM Entities

**TABLE 7.3-1
MAPPING OF DICOM ENTITIES TO LOGIQ P6 PRO ENTITIES**

DICOM	LOGIQ P6 PRO Entity
Patient	Patient
Study	Exam
Series	Exam
SR Document	Results

7.4 IOD MODULE TABLE

Within an entity of the DICOM Comprehensive SR IOD, attributes are grouped into related set of attributes. A set of related attributes is termed a module. A module facilitates the understanding of the semantics concerning the attributes and how the attributes are related with each other. A module grouping does not infer any encoding of information into data sets.

Table 7.4-1 identifies the defined modules within the entities, which comprise the DICOM Comprehensive SR IOD. Modules are identified by Module Name and Modules not described are not used.

See DICOM Part 3 for a complete definition of the entities, modules, and attributes.

TABLE 7.4-1
COMPREHENSIVE SR IMAGE IOD MODULES

Entity Name	Module Name	Reference
Patient	Patient	4.5.1.1
Study	General Study	4.5.2.1
	Patient Study	4.5.2.2
Series	SR Document Series	7.5.1
Equipment	General Equipment	4.5.4.1
Document	SR Document General	7.5.2
	SR Document Content	7.5.3
	SOP Common	4.5.6.1

7.5 INFORMATION MODULE DEFINITIONS

Please refer to DICOM Standard Part 3 (Information Object Definitions) for a description of each of the entities and modules contained within the Comprehensive SR Information Object.

The following modules are included to convey Enumerated Values, Defined Terms, and Optional Attributes supported. Type 1 & Type 2 Attributes are also included for completeness and to define what values they may take and where these values are obtained. It should be noted that they are the same ones as defined in the DICOM Standard Part 3 (Information Object Definitions). Not described tag is not used and out of scope in LOGIQ P6 PRO.

7.5.1 SR Document Series Module

TABLE 7.5-1
SR DOCUMENT SERIES MODULE

Attribute Name	Tag	Type	Attribute Description
Modality	(0008,0060)	1	Defined Term "SR" used.
Series Instance UID	(0020,000E)	1	Uniquely generated by the equipment
Series Number	(0020,0011)	1	Internal number which is incremented for each new series within a study.
Referenced Performed Procedure Step Sequence	(0008,1111)	2	Used if Modality Performed Procedure Step is enabled. Empty otherwise

7.5.2 SR Document General Module

TABLE 7.5-2
SR DOCUMENT GENERAL MODULE

Attribute Name	Tag	Type	Attribute Description
Instance Number	(0020,0013)	1	Internal number which is incremented for each new SR document within a series.
Completion Flag	(0040,A491)	1	Defined Term "PARTIAL" used.
Completion Flag Description	(0040,A492)	3	Not used
Verification Flag	(0040,A493)	1	Defined Term "UNVERIFIED" used.
Content Date	(0008,0023)	1	Date of creation, based upon user action that invoked the use of the object
Content Time	(0008,0033)	1	Time of creation, based upon user action that invoked the use of the object.
Verifying Observer Sequence	(0040,A073)	1C	Not used
>Verifying Observer Name	(0040,A075)	1	
>Verifying Observer Identification Code Sequence	(0040,A088)	2	
>>Include 'Code Sequence Macro'			
>Verifying Organization	(0040,A027)	1	
>Verification DateTime	(0040,A030)	1	
Predecessor Documents Sequence	(0040,A360)	1C	Not used.
>Include 'SOP Instance Reference Macro'			
Identical Documents Sequence	(0040,A525)	1C	Not used
>Include 'SOP Instance Reference Macro'			
Referenced Request Sequence	(0040,A370)	1C	
>Study Instance UID	(0020,000D)	1	Taken from Study Instance UID in General Study Module
>Referenced Study Sequence	(0008,1110)	2	Not used
>>Referenced SOP Class UID	(0008,1150)	1	Not used
>>Referenced SOP Instance UID	(0008,1155)	1	Not used
>Accession Number	(0008,0050)	2	Taken from Accession Number in General Study Module
>Placer Order Number/Imaging Service	(0040,2016)	2	Empty value.
>Filler Order Number/Imaging Service	(0040,2017)	2	Empty value.
>Requested Procedure ID	(0040,1001)	2	Taken from worklist if it is there
>Requested Procedure Description	(0032,1060)	2	Taken from worklist if it is there
>Requested Procedure Code Sequence	(0032,1064)	2	Empty value.
>>Include 'Code Sequence Macro'			
Performed Procedure Code Sequence	(0040,A372)	2	Empty value.
>Include 'Code Sequence Macro'			
Current Requested Procedure Evidence	(0040,A375)	1C	Not used
Pertinent Other Evidence Sequence	(0040,A385)	1C	Not used

Attribute Name	Tag	Type	Attribute Description
>Include 'SOP Instance Reference Macro'			

7.5.3 SR Document Content Module

The SR Document Content Module is described in the following table and the Template “ultrasound M&A document title”, template id GEMS_US_0100 from mapping resource 99GEMS.

**TABLE 7.5-3
SR DOCUMENT CONTENT MODULE ATTRIBUTES**

Attribute Name	Tag	Type	Attribute Description
Observation DateTime	(0040,A032)	1C	Not used
Content Template Sequence	(0040,A504)	1C	-Template id GEMS_US_0100 from mapping resource 99GEMS -Template id 5000 OBGYN Ultrasound Procedure Report from resource DCMR - Template id 5100 Vascular Ultrasound Procedure Report from resource DCMR - Template id 5100 Abdomen Ultrasound Procedure Report from resource DCMR -Template id 5200 Adult Echocardiography Procedure Report from resource DCMR
> <i>Template Identification Macro'</i>			
Value Type	(0040,A040)	1	CONTAINER
Continuity of Content	(0040,A050)	1C	SEPARATE
Concept Name Code Sequence	(0040,A043)	1C	“Ultrasound M&A document title” or “Adult Echocardiography Procedure Report”, depending on application and configuration setting.
> <i>Code Sequence Macro'</i>			
<i>Concept Value attribute(s)</i>			Not used for CONTAINER
Content Sequence	(0040,A730)	1C	See template “ultrasound M&A document title” or “Adult Echocardiography Procedure Report”, depending on application and configuration setting.
> Relationship Type	(0040,A010)	1	See template “ultrasound M&A document title” or “Adult Echocardiography Procedure Report”, depending on application and configuration setting.
> Referenced Content Item Identifier	(0040,DB73)	1C	Not used
> <i>SR Document Content Module</i>			See template “ultrasound M&A document title” or “Adult Echocardiography Procedure Report”, depending on application or configuration setting.

7.5.3.1 SR Document Content Descriptions

7.5.3.1.1 Content Template

LOGIQ P6 PRO supports the following root Templates for SR SOP Instances created, processed, or displayed by LOGIQ P6 PRO.

**TABLE 7.5-4
SR ROOT TEMPLATES**

SOP Class	Template ID	Template Name	Use
Comprehensive SR	GEMS_US_0100	ultrasound M&A document title	Create
Comprehensive SR	5000	“OB-GYN Ultrasound Procedure Report”	Create
Comprehensive SR	5100	“Vascular Ultrasound Procedure Report”	Create
Comprehensive SR	5200	“Adult Echocardiography Procedure Report”	Create

7.6 STANDARD EXTENDED AND PRIVATE DATA ATTRIBUTES

Not applicable.

7.7 STANDARD EXTENDED AND PRIVATE CONTEXT GROUPS

May be used if context groups are extended.

7.8 STANDARD EXTENDED AND PRIVATE TEMPLATES

LOGIQ P6 PRO supports the Standard Extended and Private Templates defined in the following sections. Also note that information (e.g. content item) not described in this section is not supported.

7.8.1 Standard Extended Templates

- i. Usage and Extension of TID 5100 Vascular Ultrasound Report.
LOGIQ P6 PRO supports the following template TID 5100 for SOP Instances created by this product when exam types selected are Vascular and Abdomen.

	NL	Relation with Parent	Value type	Concept Name	VM	Req Type	Condition	Value Set Constraint
1			CONTAINER	EV(125100,DCM, “Vascular Ultrasound Procedure Report”)	1	M		
	>	HAS OBS CONTEXT	INCLUDE	DTID (1001) Observation Context	1	M		
	>	CONTAINS	INCLUDE	DTID(5101) Vascular Patient Characteristics	1	U		
	>	CONTAINS	INCLUDE	DTID (5102) Vascular Procedure Summary Section	1	U		
	>	CONTAINS	INCLUDE	DTID (5103) Vascular Ultrasound Section	1-n	U		

- ii. TID 5101 Vascular Patient Characteristics

	NL	Relation with Parent	Value type	Concept Name	VM	Req Type	Condition	Value Set Constraint
1			CONTAINER	EV (121118, DCM, “ Patient	1	M		

				Characteristics”)				
	>	CONTAINS	NUM	EV (121033, DCM, “Subject Age”)	1	U		Units = DCID (7456) Units of Measure for Age
	>	CONTAINS	CODE	EV (121032, DCM, “Subject Sex”)	1	U		DCID (7455) Sex
	>	CONTAINS	NUM	EV (8867-4, LN, “Heart Rate”)	1	U		
	>	CONTAINS	NUM	EV (F-008EC, SRT, “Systolic Blood Pressure”)	1	U		
	>	CONTAINS	NUM	EV (F-008ED, SRT, “Diastolic Blood Pressure”)	1	U		

iii. TID 5102 Vascular Procedure Summary Section

	NL	Relation with Parent	Value type	Concept Name	VM	Req Type	Condition	Value Set Constraint
1			CONTAINER	DT (121111, DCM, “Summary”)	1	M		
	>	CONTAINS	TEXT	EV (121106, DCM, “Comment”)	1	M		

iv. TID 5103 Vascular Ultrasound Section

	NL	Relation with Parent	Value type	Concept Name	VM	Req Type	Condition	Value Set Constraint
1			CONTAINER	DT (121070, DCM, “Findings”)	1	M		
	>	HAS CONCEPT MOD	CODE	EV (G-C0E3, SRT, Finding Site”)	1	M		See Table vi GEU Applications and Extensions - \$SectionScope
	>	HAS CONCEPT MOD	CODE	EV (G-C171, SRT, Laterality”)	1	M	IFF Laterality is defined	See Table xi GE Ultrasound Sidedness and Vessel Location
		HAS CONCEPT MOD	CODE	EV (G-0373, SRT, “Image Mode”)	1	U		See Table viii GE Ultrasound modes.
	>	CONTAINS	INCLUDE	DTID (5104) Vascular Measurement Group	1-n	M		See Table v TID 5104 Vascular Ultrasound Measurement Group
	>	CONTAINS	INCLUDE	DTID (300) Measurement	1-n	U		\$Measurement = \$AnatomyRatio

v. TID 5104 Vascular Ultrasound Measurement Group (extended)

	NL	Relation with Parent	Value type	Concept Name	VM	Req Type	Condition	Value Set Constraint
1			CONTAINER	\$Anatomy GEU Parameters	1	M		See Table vi GEU Applications and Extensions – Anatomy GEU Parameter
	>	HAS CONCEPT MOD	CODE	EV (G-A1F8, SRT, ‘Topographical Modifier’)	1	U		See Table xi GE Ultrasound Sidedness and Vessel Location
	>	HAS CONCEPT MOD	Text	EV (125101, DCM, ‘Vessel Branch’)	1	UC	When user name vessel more specific	Vessel branch defined by user.
	>	HAS CONCEPT MOD	Text	EV (GEU-1005-7, 99GEMS, ‘Anatomy Label’)	1	UC	When user insert user defined study measurements	Text Value of Vessel Name or Folder
	>	CONTAINS	INCLUDE	DTID (300) Measurement	1-n	UC		\$Measurement = See Table x. Vascular Base Measurement \$Derivation = See DCID (3627) Measurement Type

vi. GEU Applications and Extensions

SectionScope	Section Laterality	Anatomy	Anatomy Ratio	GEU Parameters Base Measurement Concept Name	
EV (G-C171, SRT, ‘Laterality’)	EV (G-C171, SRT, Laterality’)				
(T-40501, SRT, ‘Blood Vessel of Head’)	(G-A101, SRT, Left) for Left, (G-A100, SRT, Right) for Right. Or (G-A103, SRT, Unilateral)	DCID 12105 Intracranial Cerebral Vessels Or DCID 12106 Intracranial Cerebral Vessels (Unilateral)		Anatomy GEU parameter	Code and Description
				ICA	(T-45300, SRT, ‘Internal Carotid Artery’)
				MCA	(T-45600, SRT, ‘Middle Cerebral Artery’)
				ACA	(T-45540, SRT, ‘Anterior Cerebral Artery’)
				PCA	(T-45900, SRT, ‘Posterior Cerebral Artery’)
				PCoMA	(T-45320, SRT, ‘Posterior Communicating Artery’)
				ACoMA	(T-45530, SRT, ‘Anterior Communicating Artery’)
				BA	(T-45800, SRT, ‘Basilar Artery’)
				VERT	(T-45700, SRT, ‘Vertebral Artery’)
Table v.1 TCD Study Folder Code MAP					
(T-45005, SRT, ‘Artery of neck’)	(G-A101, SRT, Left) for Left, or (G-A100, SRT, Right) for Right.	DCID (12104) Extracranial Arteries	DCID (12123) Carotid Ratios	Anatomy GEU parameter	Code and Description
				VERT	(T-45700, SRT, ‘Vertebral Artery’)
				CCA	(T-45100, SRT, ‘Common Carotid Artery’)
				ICA	(T-45300, SRT, ‘Internal Carotid Artery’)
				BULB	(T-45170, SRT, ‘Carotid Bulb’)
ECA	(T-45200, SRT, ‘External Carotid Artery’)				

				SUBC (T-46100, SRT, 'Subclavian Artery')	
				Table v.2 Carotid Study FOLDER Code MAPS	
(T-47040, SRT, 'Artery of Lower Extremity')	(G-A101, SRT, Left) for Left, or (G-A100, SRT, Right) for Right.	DCID (12109) Lower Extremity Arteries		Anatomy GEU parameter	Code and Description
				ComIliac	(T-46710, SRT, "Common Iliac Artery")
				ExtIliac	(T-46910, SRT, "External Iliac Artery")
				ComFemoral	(T-47400, SRT, "Common Femoral Artery")
				SupFemoral	(T-47403, SRT, "Superficial Femoral Artery")
				Popliteal	(T-47500, SRT, "Popliteal Artery")
				AntTibial	(T-47700, SRT, "Anterior Tibial Artery")
				PostTibial	(T-47600, SRT, "Posterior Tibial Artery")
				Peroneal	(T-47630, SRT, "Peroneal Artery")
				DorsPedis	(T-47741, SRT, "Dorsalis Pedis Artery")
				DeepFemoral	(T-47440, SRT, "Profunda Femoris Artery")
Profunda	(T-47440, SRT, "Profunda Femoris Artery")				
				Table V.3 LEA STUDY Folder CODE MAPS	
(T-49403, SRT, 'Vein of Lower Extremity')	(G-A101, SRT, Left) for Left, or (G-A100, SRT, Right) for Right.	DCID (12110) Lower Extremity of Veins		Anatomy GEU parameter	Code and Description
				Popliteal	(T-49640, SRT, "Popliteal Vein")
				LSaphenous	(T-49550, SRT, "Lesser Saphenous Vein")
				AntTibial	(T-49630, SRT, "Anterior Tibial Vein")
				PostTibial	(T-49620, SRT, "Posterior Tibial Vein")
				Peroneal	(T-49650, SRT, "Peroneal Vein")
Profunda	(T-49660, SRT, "Profunda Femoris Vein")				
				Table V.4 LEV STUDY FOLDER CODE MAPS	
(T-47020, SRT, "Artery of Upper Extremity")	(G-A101, SRT, Left) for Left, or (G-A100, SRT, Right) for Right. Or (G-A103, SRT, Unilateral)	DCID (12107) Upper Extremity Arteries		Section Artery of Upper Extremity	
				Anatomy GEU parameter	Code and Description
				SUBC	(T-46100, SRT, "Subclavian artery")
				Axill	(T-47100, SRT, "Axillary artery")
				BrachialA	(T-47160, SRT, "Brachial artery")
				RadialA	(T-47300, SRT, "Radial artery")
				UlnarA	(T-47200, SRT, "Ulnar artery")
				Palmar	(T-47340, SRT, "Deep Palmar Arch of Radial Artery")
Innomonat	(T-46010, SRT, "Innominate Artery")				
				Table V.5 UEA Study Folder CODE MAPS	
(T-49103, SRT, "Vein of Upper Extremity")	(G-A101, SRT, Left) for Left, or (G-A100, SRT, Right) for Right.	DCID (12108) Upper Extremity Veins		Anatomy GEU parameter	Code and Description
				JugularV	(T-48170, SRT, "Internal Jugular vein")
				InnoV	(T-48620, SRT, "Innominate vein")
				SUBCV	(T-48330, SRT, "Subclavian vein")
				AxillV	(T-49110, SRT, "Axillary vein")
				CephV	(T-49240, SRT, "Cephalic vein")
				BasilV	(T-48052, SRT, "Basilic vein")
				BracV	(T-49350, SRT, "Brachial vein")
				McubV	(T-49250, SRT, "Median Cubital vein")
				RadialV	(T-49340, SRT, "Radial vein")
UlnarV	(T-49330, SRT, "Ulnar vein")				

				TABLE V.6 UEV STUDY FOLDER CODE MAPS	
(T-71019, SRT, "Vascular Structure of Kidney")	(G-A101, SRT, Left) for Left, or (G-A100, SRT, Right) for Right.	DCID(12115) Renal Vessels		Anatomy GEU parameter	Code and Description
				MRenalA	(T-46600, SRT, "Renal Artery")
				RenalV	(T-48740, SRT, "Renal Vein")
				SegmentalA	(T-46659, SRT, "Segmental Artery")
				InterlobarA	(T-4667D, SRT, "Interlobar Artery of Kidney")
				ArcurateA	(T-4668A, SRT, "Arcuate Artery of the Kidney")
				TABLE V.7 RENAL STUDY CODE MAPS	
(T-46002, SRT, "Artery of Abdomen"),	(G-A101, SRT, Left) for Left, (G-A100, SRT, Right) for Right. Or (G-A103, SRT, Unilateral)	DCID 12111 or (12112) Abdominal Arteries (unilateral)		Anatomy GEU parameter	Code and Description
				Aorta	(T-42000, SRT, "Aorta")
				Table V.8 Abdomen Study CODE MAPS	
(T-487A0, SRT, "Vein of Abdomen)	(G-A101, SRT, Left) for Left, (G-A100, SRT, Right) for Right. Or (G-A103, SRT, Unilateral)	DCID 12113 or (12114) Abdominal Veins lateral (unilateral)		Anatomy GEU parameter	Code and Description
				IVC	(T-48710, SRT, "Inferior Vena Cava")
				Table V.9 Abdomen Vein Study Folder Code MAPS	

vii. TID 300 Measurement (extended for Vascular)

	NL	Relation with Parent	Value Type	Concept Name	VM	Req Type	Condition	Value Set Constraint
1			NUM	\$Measurement	1	M		Units = \$Units
2	>	HAS CONCEPT MOD	TEXT	EV(GEU-1005-5, 99GEMS, Measurement Label)	1	UC	When Measurement is created by user (User Defined)	Measurement Label created by User (\$Label)
3	>	HAS CONCEPT MOD	CODE	EV(GEU-1005-5, 99GEMS, Measurement Label)	1	UC	Only for AP or Trans	- AP (Anterior-Posterior, DCM, 122675) - Trans (Transverse, SRT, G-A117)
4	>	HAS CONCEPT MOD	CODE	EV(G-A1F8, SRT, 'Topographical modifier')	1	U		See Table viii GE Ultrasound Sidedness and Vessel Location
5	>	HAS CONCEPT MOD	CODE	EV(121401, DCM, 'Derivation')	1	U		\$Derivation
6	>	HAS CONCEPT MOD	CODE	EV(121404, DCM, 'Selection Status')	1	U		\$Selection Status

viii. TID 1001 Observation Context

	NL	Relation with Parent	Value Type	Concept Name	VM	Req Type	Condition	Value Set Constraint
1		HAS CONCEPT MOD	INCLUDE	DTID(1002, 'Observer Context')	1-n	MC	Required if all aspects of	\$Observer Context

							observer context are not inherited.	
2	>	HAS CONCEPT MOD	INCLUDE	DTID(1005,DCM, 'Procedure Context')	1-n	MC	Required if all aspects of observer context are not inherited.	\$Procedure Context
3	>	HAS CONCEPT MOD	INCLUDE	DTID(1006,DCM, 'Subject Context')	1-n	MC	Required if all aspects of observer context are not inherited.	\$Subject Context

ix. TID 1008 Measurement (Subject context, Fetus)

	NL	Relation with Parent	Value Type	Concept Name	VM	Req Type	Condition	Value Set Constraint
1			PNAME	EV(121036,DCM, 'Mother of fetus')	1	U		Defaults to an observation subject that is a patient prior to replacing the Observation Subject Class with Fetus.
2	>		UIDREF	EV(121028,DCM, 'Subject ID')	1	U		For longitudinal tracking of individual fetuses
3	>		TEXT	EV(121030,DCM, 'Subject ID')	1	MC		For longitudinal tracking of individual fetuses (human readable value e.g. "A" or "1")
4	>		TEXT	EV(1195101,LN, 'Fetus ID')	1	MC		For separation of multiple fetuses during this procedure e.g. fetus '1' of '2' ...not for Longitudinal comparisons.; ie. the *m* of fetus *m* of *n*
5	>		TEXT	EV(11878-6,DCM, 'Number of Fetuses')	1	U		i.e. the "n" of fetus "m" of "n" Units EV (1,UCUM,"no units")

x. SR Mapping Table for Vascular Vessel Segment Modifiers Measurement Concept
(Extracted from DCID 11226 Vessel Segment Modifiers)

Name of Parameter in User Interface	Code Value
Prox	(G-A118, SRT, Proximal)
Mid	(G-A188, SRT, Mid-longitudinal)
Dist	(G-A119, SRT, Distal)

xi. SR Mapping Table for Vascular Base Measurement Concept

Name of Parameter in User Interface	Standard Measurement Concept Name
PS	(11726-7, LN, "Peak Systolic Velocity")
ED	(11653-3, LN, "End Diastolic Velocity")

MD	(11665-7, LN, "Minimum Diastolic Velocity")
Tamax	(11692-1, LN, "Time averaged peak velocity")
PI	(12008-9, LN, "Pulsatility Index")
RI	(12023-8, LN, "Resistivity Index")
SD Ratio	(12144-2, LN, "Systolic to Diastolic Velocity Ratio")
Accel	(20167-3, LN, "Acceleration Index")
AT	(20168-1, LN, "Acceleration Time")
TAMEAN	(20352-1, LN, "Time averaged mean velocity")
VOLFLOW	(33878-0, LN, "Volume flow")
ICA/CCA Ratio (PS)	(33868-1, LN, "ICA/CCA velocity") with Concept Modifier (R-4089A, SRT, Cardiac Cycle Point) = (F-32030, SRT, Systole)
ICA/CCA Ratio (ED)	(33868-1, LN, "ICA/CCA velocity") with Concept Modifier (R-4089A, SRT, Cardiac Cycle Point) = (F-32010, SRT, Diastole)

Note: If there are multiple measurements, the measurement, which noted for further processing has possible derivation and selection, which listed below:

Name of Parameter in User Interface
(121401, DCM, "Derivation") = (R-00317, SRT, "Mean")
(121401, DCM, "Derivation") = (G-A437, SRT, "Maximum")
(121401, DCM, "Derivation") = (R-404FB, SRT, "Minimum")
(121404, DCM, "Selection Status") = (121411, DCM, "Most recent value chosen")
(121404, DCM, "Selection Status") = (121410, DCM, "User chosen value")
(121401, DCM, "Derivation") = (121428, DCM, "Calculated")

xii. Usage of TID 5000 OB-GYN Ultrasound Procedure Report

	NL	Relation with Parent	Value type	Concept Name	VM	Req Type	Condition	Value Set Constraint
1			CONTAINER	EV (125000, DCM, "OB-GYN Ultrasound Procedure Report")	1	M		
	>	HAS OBS CONTEXT	INCLUDE	DTID (1001) Observation Context	1	M		
	>	CONTAINS	INCLUDE	DTID (5001) Patient Characteristics	1	U		
	>	CONTAINS	INCLUDE	DTID (5002) OB-GYN Procedure Summary Section	1	U		
	>	CONTAINS	INCLUDE	DTID (5004) Fetal Biometry Ratio Section	1-n	U		
	>	CONTAINS	INCLUDE	DTID (5005) Fetal Biometry Section	1-n	U		
	>	CONTAINS	INCLUDE	DTID (5006) Long Bones Section	1-n	U		
	>	CONTAINS	INCLUDE	DTID (5007) Fetal Cranium Section	1-n	U		
	>	CONTAINS	INCLUDE	DTID (5009) Fetal Biophysical Profile Section	1-n	U		
	>	CONTAINS	INCLUDE	DTID (5011) Early Gestation Section	1-n	U		
	>	CONTAINS	INCLUDE	DTID (5010) Amniotic Sac Section	1	U		

	>	CONTAINS	INCLUDE	DTID (5015) Pelvis and Uterus Section	1	U		
	>	CONTAINS	INCLUDE	DTID (5012) Ovaries Section	1	U		
	>	CONTAINS	INCLUDE	DTID (5013) Follicles Section	1	U		\$Laterality = EV (G-A100, SRT, "Right") for Right, (G-A101, SRT, "Left") for Left, \$Number = EV (11880-2, LN, "Number of follicles in right ovary"), (11879-4, LN, "Number of follicles in left ovary")

xiii. TID 5001 OB-GYN Patient Characteristics

	NL	Relation with Parent	Value Type	Concept Name	VM	Req Type	Condition / Notes
1			CONTAINER	EV (121118, DCM, "Patient Characteristics")		M	
	>	CONTAINS	TEXT	EV (121106, DCM, "Comment")	1	U	
	>	CONTAINS	NUM	EV (8302-2, LN, "Patient Height")	1	U	See GEU SR Mapping Table
	>	CONTAINS	NUM	EV (11996-6, LN, "Gravida")	1	U	See GEU SR Mapping Table
	>	CONTAINS	NUM	EV (11977-6, LN, "Para")	1	U	See GEU SR Mapping Table
	>	CONTAINS	NUM	EV (11612-9, LN, "Aborta")	1	U	See GEU SR Mapping Table
	>	CONTAINS	NUM	EV (33065-4, LN, "Ectopic Pregnancies")	1	U	See GEU SR Mapping Table

xiv. GEU SR Mapping Table for Patient Characteristics

Name of GEU parameter	Base Measurement Concept Name
Gravida	(11996-6, LN, 'Gravida')
Para	(11977-6, LN, Para)
Abortion	(11612-9, LN, Aborta)
Ectopic	(33065-4, LN, Ectopic Pregnancies)

xv. TID 5002 OB-GYN Procedure Summary Section

	NL	Relation with Parent	Value type	Concept Name	VM	Req Type	Condition	Value Set Constraint
1			CONTAINER	DT(121111, DCM, Summary)	1	M		
	>	CONTAINS	INCLUDE	DCID (12003) OBGYN Dates	1	U		

	>	CONTAINS	DATE	DTID (300) Measurement	1	U		\$Measurement= D (12018) OBGYN Summary
	>	CONTAINS	INCLUDE	EV (121106, DCM, "Comment")	1	U		
	>	CONTAINS	TEXT	BTID (5003) OB-GYN Fetus Summary	1-n	U	No more than 1 inclusion per fetus	

xvi. TID 5003 OB-GYN Fetus Summary

	NL	Relation with Parent	Value type	Concept Name	VM	Req Type	Condition	Value Set Constraint
1			CONTAINER	DT (125008, DCM, "Fetus Summary")	1	M		
	>	HAS OBS CONTEXT	INCLUDE	DTID (1008) Subject Context, Fetus	1	MC	To describe n fetus, invokes this template n times	
		CONTAINS	TEXT	EV(121106, ,Comment)	1-n	U		
	>	CONTAINS	NUM	EV(11948-7, LN, Fetal Heart Rate)	1	C	If Fetal Heart Rate (HR) is performed	
		CONTAINS	DATE	DTID (300) Measureme nt	1-n	U		\$Measurement = DCID (12019) OB-GYN Fetus Summary, (12003) OB-GYN DATES, \$Equation = DCID (12012) OB Equations and Tables

xvii. TID 5004 FETAL BIOMETRY RATIO SECTION

	NL	Relation with Parent	Value type	Concept Name	VM	Req Type	Condition	Value Set Constraint
1			CONTAINER	DT (125001, DCM, "Fetus Biometry Rations")	1	M		
	>	HAS OBS CONTEXT	INCLUDE	DTID (1008,, "Subject Context, Fetus")	1	MC	IF this template is invoked more than once to describe more than one fetus	
	>	CONTAINS	NUM	DCID (12004, , "Fetus Biometry Rations")	1-n	M		
	>>	RINFERRED FROM	NUM		2	U		
	>	HAS PROPERTIES	INCLUDE	DTID (312, , "Normal Range Properties")	1	U		

xviii. TID 5005 FETAL BIOMETRY SECTION

	NL	Relation with Parent	Value type	Concept Name	VM	Req Type	Condition	Value Set Constraint
1			CONTAINER	DT (125002, DCM, "Fetus	1	M		

				Biometry”)				
	>	HAS OBS CONTEXT	INCLUDE	DTID (1008,, “Subject Context, Fetus”)	1	MC	IF this template is invoked more than once to describe more than one fetus	
	>	CONTAINS	NUM	DTID (5008,, “Fetus Biometry Group”)	1-n	M		\$BiometryType = MemberOf DCID (12005) Fetal Biometry Measurements

xix. TID 5006 FETAL LONG BONES SECTION

	NL	Relation with Parent	Value type	Concept Name	VM	Req Type	Condition	Value Set Constraint
1			CONTAINER	DT (125003, DCM, “Fetus Long Bones”)	1	M		
	>	HAS OBS CONTEXT	INCLUDE	DTID (1008,, “Subject Context, Fetus”)	1	MC	IF this template is invoked more than once to describe more than one fetus	
	>	CONTAINS	NUM	DTID (5008,, “Fetus Biometry Group”)	1-n	M		BiometryType = MemberOf DCID (12006) Fetal Long Bones Biometry Measurements

xx. TID 5007 FETAL CRANIUM SECTION

	NL	Relation with Parent	Value type	Concept Name	VM	Req Type	Condition	Value Set Constraint
1			CONTAINER	DT (125004, DCM, “Fetus Cranium”)	1	M		
	>	HAS OBS CONTEXT	INCLUDE	DTID (1008,, “Subject Context, Fetus”)	1	MC	IF this template is invoked more than once to describe more than one fetus	
	>	CONTAINS	NUM	DTID (5008,, “Fetus Biometry Group”)	1-n	M		BiometryType = MemberOf DCID (12007) Fetal Cranium

xxi. TID 5008 FETAL BIOMETRY GROUP

	NL	Relation with Parent	Value type	Concept Name	VM	Req Type	Condition	Value Set Constraint
1			CONTAINER	DT (125005, DCM, “Biometry Group”)	1	M		
	>	CONTAINS	INCLUDE	DTID (300, , “Measurement”)	1-n	MC	At least one of 2 and 3 shall be present	\$Measurement = of 2 and 3 shall be present \$BiometryType \$Derivation = DCID (3627) Measurement Type
	>	CONTAINS	NUM	EV (18185-9, , “Gestational Age”)	1	MC	At least one of 2 and 3 shall be present	Units= EV(d,UCUM,days)

	>>	INFERRED FROM	CODE	DTID (228, , “Equation or Table”)	1	U		DCID (12013) Gestational Age Equations and Tables
	>>	INFERRED FROM	NUM	(121414,DCM , “Standard deviation of Population”)	1	U		
	>> >	HAS PROPERTIES	CODE	(121402,DCM , “Normality ”)	1	UC	If row 5	(SRT, R-002C4, Abnormally High), (SRT, R-002C5, Abnormally Low), (SRT, G-A460, Normal)
	>>	RINFERRED FROM	NUM		1-n	U		
	>>	HAS PROPERTIES	NUM	DTID (226, , “Population Statistical Descriptors ”)	1-n	U		
	>	CONTAINS	NUM	DTID (12017, , “Growth Distribution Rank ”)	1	U		
	>>	INFERRED FROM	CODE	DTID (228, , “Equation or Table ”)	1	U		DCID (12015) Fetal Growth Equations and Tables

xxii. GEU Parameters Map from TID 5009 Fetal Biophysical Profile Section

	NL	Relation with Parent	Value type	Concept Name	VM	Req Type	Condition	Value Set Constraint
1			CONTAINER	DT (125006, DCM, “Biophysical Profile”)	1	M		
	>	HAS OBS CONTEXT	INCLUDE	DTID (1008,, “Subject Context, Fetus”)	1	MC	IF this template is invoked more than once to describe more than one fetus	
	>	CONTAINS	NUM	EV (11631-9, LN, “Gross Body Movement”)	1	MC	At least one of row 3-7 shall be present	Units = DT (“0:2”, UCUM, “range 0:2”)
	>	CONTAINS	NUM	EV (11632-7, LN, “Fetal Breathing”)	1	MC	At least one of row 3-7 shall be present	Units = DT (“0:2”, UCUM, “range 0:2”)
	>	CONTAINS	NUM	EV (11635-0, LN, “Fetal Tone”)	1	MC	At least one of row 3-7 shall be present	Units = DT (“0:2”, UCUM, “range 0:2”)
	>	CONTAINS	NUM	EV (11635-5, LN, “Fetal Heart Reactivity”)	1	MC	At least one of row 3-7 shall be present	Units = DT (“0:2”, UCUM, “range 0:2”)
	>	CONTAINS	NUM	EV (11630-1, LN, “Amniotic Fluid Volume”)	1	MC	At least one of row 3-7 shall be present	Units = DT (“0:2”, UCUM, “range 0:2”)
	>	CONTAINS	NUM	DT (11634-3, LN, “Biophysical Profile Sum Score”)	1	U		

xxiii. TID 5010 AMNIOTIC SAC SECTION

	NL	Relation with Parent	Value type	Concept Name	VM	Req Type	Condition	Value Set Constraint
1			CONTAINER	DT (125070, DCM, “Findings”)	1	M		

	>	HAS OBS CONTEXT	CODE	EV (125070, SRT, "Findings Site")	1	M		DT (T-F1300, SRT, "Amniotic Sac")
	>	HAS OBS CONTEXT	INCLUDE	DTID (1008,, "Subject Context, Fetus")	1	MC	IF this template is invoked more than once to describe more than one fetus	
	>	CONTAINS	INCLUDE	DTID (300, , "Measurement")	1	M		\$Measurement = DT (11627-7, LN, "Amniotic Fluid Index")
	>	CONTAINS	INCLUDE	DTID (300, , "Measurement")	4	M		\$Measurement = DCID (12008) OB-GYN Amniotic Sac

xxiv. TID 5011 EARLY GESTATION SECTION

	NL	Relation with Parent	Value type	Concept Name	VM	Req Type	Condition	Value Set Constraint
1			CONTAINER	DT (125009, DCM, "Early Gestation")	1	M		
	>	HAS OBS CONTEXT	INCLUDE	DTID (1008,, "Subject Context, Fetus")	1	MC	IF this template is invoked more than once to describe more than one fetus	
	>	CONTAINS	NUM	DTID (5008,, "Fetus Biometry Group")	1-n	M		\$BiometryType= Member of DCID (12009) Early Gestation Biometry Measurements

xxv. TID 5012 OVARIES SECTION

	NL	Relation with Parent	Value type	Concept Name	VM	Req Type	Condition	Value Set Constraint
1			CONTAINER	DT (121070, DCM, "Findings")	1	M		
	>	HAS CONCEPT MOD	CODE	EV (G-C0E3,SRT, "Findings Site")	1	M		DT (T-87000, SRT, "Ovary")
	>	CONTAINS	INCLUDE	DTID (5016, , "LWH Volume Group")	1	U		\$GroupName = EV (T-87000, SRT, "Ovary") \$Width =EV (11829-9, LN, "Left Ovary Width") \$Length =EV (11840-6, LN, "Left Ovary Length") \$Height =EV (11857-0 , LN," Left Ovary Height") \$Volume=EV (12164-0, LN, "Left Ovary Volume")

	>	CONTAINS	INCLUDE	DTID (5016, , "LWH Volume Group")	1	U		\$GroupName = EV (T-87000, SRT, "Ovary") \$Width = EV (11830-7, LN, "Right Ovary Width") \$Length = EV (11841-4, LN, "Right Ovary Length") \$Height = EV (11858-8, LN, "Right Ovary Height") \$Volume = EV (12165-7, LN, "Right Ovary Volume")
--	---	----------	---------	-----------------------------------	---	---	--	--

xxvi. TID 5013 FOLLICLES SECTION

	NL	Relation with Parent	Value type	Concept Name	VM	Req Type	Condition	Value Set Constraint
1			CONTAINER	DT (121070, DCM, "Findings")	1	M		
	>	HAS CONCEPT MOD	CODE	EV (G-C0E3,SRT, "Findings Site")	1	M		DT (T-87600, SRT, "Ovarian Follicle")
	>	HAS CONCEPT MOD	CODE	EV (G-C171,SRT, "Laterality")	1	U		\$Laterality

xxvii. TID 5015 PELVIS AND UTERUS SECTION

	NL	Relation with Parent	Value type	Concept Name	VM	Req Type	Condition	Value Set Constraint
1			CONTAINER	DT (125011, DCM, "Pelvis and Uterus")	1	M		
	>	CONTAINS	INCLUDE	DTID (5016, , "LWH Volume Group")	1	U		\$GroupName = EV (T-83000, SRT, "Uterus") \$Width = EV (11865-3, LN, "Uterus Width") \$Length = EV (11842-2, LN, "Uterus Length") \$Height = EV (11859-6, LN, "Uterus Height") \$Volume = EV (33192-6, LN, "Uterus Volume")
	>	CONTAINS	INCLUDE	DTID (300, , "Measurement")	1-n	M		\$Measurement = DCID (12011) Ultrasound Pelvis and Uterus \$Derivation = DCID (3627)

								Measurement Type
--	--	--	--	--	--	--	--	------------------

xxviii. GEU Parameters Map from Context ID 12019 OB-GYN Fetus Summary

Name of GEU parameter	Base Measurement Concept Name
OB/CUA	(11888-5, LN, Composite Ultrasound Age)
EFW(AC,BPD)	(11727-5, LN, "Estimated Weight")

xxix. GEU Parameters Map from Context ID 12019 OB-GYN Fetus Summary

Name of GEU parameter	Base Measurement Concept Name
Gyn/2D/UtL	(11842-2, LN, Uterus Length)
Gyn/2D/UtH	(11859-6, LN, Uterus Height)
Gyn/2D/UtW	(11865-3, LN, Uterus Width)
Gyn/2D/UtVolume	(33192-6, LN, Uterus Volume)
Gyn/2D/Endo	(12145-9, LN, "Endometrium Thickness")
Ob/2D/OvL with Side=Rt	(11841-4, LN, "Right Ovary Length")
Ob/2D/OvH with Side=Rt	(11858-8, LN, "Right Ovary Height")
Ob/2D/OvW with Side=Rt	(11830-7, LN, "Right Ovary Width")
Ob/2D/OvVolume with Side=Rt	(12165-7, LN, "Right Ovary Volume")
Ob/2D/OvL with Side=Lt	(11840-6, LN, Left Ovary Length)
Ob/2D/OvH with Side=Lt	(11857-0, LN, Left Ovary Height)
Ob/2D/OvW with Side=Lt	(11829-9, LN, Left Ovary Width)
Ob/2D/OvVolume with Side=Lt	(12164-0, LN, Left Ovary Volume)
Gyn/2D/OvFoVolume/Volume	(G-D705, SRT, "Volume")

xxx. GEU Parameter Map from Context ID 12005 Fetal Biometry Measurements

Name of GEU parameter	Base Measurement Concept Name
BPD	(11820-8, LN, "Biparietal Diameter")
AC	(11979-2, LN, "Abdominal Circumference")
OFD	(11851-3, LN, "Occipital-Frontal Diameter")
FL	(11963-6, LN, "Femur Length")
HC	(11984-2, LN, "Head Circumference")
TAD	(11862-0, LN, "Transverse Abdominal Diameter")
TCD	(11863-8, LN, "Trans Cerebellar Diameter")
TTD	(11864-6, LN, "Transverse Thoracic Diameter")
Ft	(11965-1, LN, "Foot length")
FTA	(33068-8, LN, "Thoracic Area")
APTD	(11819-0, LN, "Anterior-Posterior Trunk Diameter")

xxxi. GEU Parameter Map from Context ID 12004 Fetal Biometry Ratios

Name of GEU parameter	Base Measurement Concept Name
Ratio HC/AC	(11947-9, LN, "HC/AC")
Ratio FL/BPD	(11872-9, LN, "FL/BPD")
Ratio FL/AC	(11871-1, LN, "FL/AC")
Ratio FL/HC	(11873-7, LN, "FL/HC")
CI	(11823-2, LN, "Cephalic Index")

xxxii. GEU Parameter Map from Context ID 12005 Fetal Long Bones Measurement

Name of GEU parameter	Base Measurement Concept Name
TCD	(11863-8, LN, "Trans Cerebellar Diameter")
OOD	(11629-3, LN, "Outer Orbital Diameter")
IOD	(33070-4, LN, "Inner Orbital Diameter")
LV	(12171-5, LN, "Lateral Ventricular width")
NT	(33069-6, LN, "Nuchal Translucency")
FL	(11963-6, LN, "Femur Length")
HL	(11966-9, LN, "Humerus length")
ULNA	(11969-3, LN, "Ulna length")
TIB	(11968-5, LN, "Tibia length")
FIB	(11964-4, LN, "Fibula length")
Radius	(11967-7, LN, "Radius length")
CLA	(11962-8, LN, "Clavicle length")

xxxiii. GEU Parameter Map from Context ID 12013 Gestational Age Equations and Tables

Name of GEU parameter	Base Measurement Concept Name
Campbell/Ratio HC/AC-Min	(33182-7, LN, "HC/AC by GA, Campbell 1977")
OB/Campbell/Ratio HC/AC-Max	(33182-7, LN, "HC/AC by GA, Campbell 1977")
OB/Jeanty/BPD-GP	(33153-8, LN, "BPD by GA, Jeanty 1982")
OB/Jeanty/HC-GP	(33175-1, LN, "HC by GA, Jeanty 1982")
OB/Jeanty/FL-GP	(33168-6, LN, "FL by GA, Jeanty 1982")
OB/Hadlock/BPD-GP	(33198-3, LN, "BPD by GA, Hadlock 1984")
OB/Hadlock/AC-GP	(33146-2, LN, "AC by GA, Hadlock 1984")
OB/Hadlock/HC-GP	(33173-6, LN, "HC by GA, Hadlock 1984")
OB/Hadlock/FL-GP	(33166-0, LN, "FL by GA, Hadlock 1984")
OB/ASUM/BPD-GA	(33079-5, LN, "BPD, ASUM 1989")
OB/ASUM/CRL-GA	(33089-4, LN, "CRL, ASUM 1991")
Eriksen/TAD-GA	(33128-0, LN, "TAD, Eriksen 1985")
OB/Goldstein/TCD-GA	(33133-0, LN, "TCD, Goldstein 1987")
OB/Hohler/FL-GA	(11922-2, LN, "FL, Hohler 1982")
OB/Jeanty/CRL-GA	(33092-8, LN, "CRL, Jeanty 1982")
OB/Jeanty/BPD-GA	(33539-8, LN, "BPD, Jeanty 1982")
OB/Jeanty/AC-GA	(33537-2, LN, "AC, Jeanty 1982")
OB/Jeanty/HC-GA	(33113-2, LN, "HC, Jeanty 1982")
OB/Jeanty/FL-GA	(33099-3, LN, "FL, Jeanty 1982")
OB/Jeanty/ULNA-GA	(11944-6, LN, "Ulna, Jeanty 1984")
OB/Jeanty/HL-GA	(11936-2, LN, "Humerus, Jeanty 1984")
OB/Jeanty/TIB-GA	(11941-2, LN, "Tibia, Jeanty 1984")
OB/Jeanty/FIB-GA	(33097-7, LN, "Fibula, Jeanty 1983")
OB/Jeanty/Radius-GA	(33126-4, LN, "Radius, Jeanty 1983")
OB/Merz/BPD-GA	(33081-1, LN, "BPD, Merz 1988")
OB/Merz/AC-GA	(33075-3, LN, "AC, Merz 1988")
OB/Merz/HC-GA	(33115-7, LN, "HC Merz, 1988")
OB/Merz/FL-GA	(33542-2, LN, "FL, Merz 1988")
OB/Hadlock/BPD-GA	(11902-4, LN, "BPD, Hadlock 1984")
OB/Hadlock/AC-GA	(11892-7, LN, "AC, Hadlock 1984")
OB/Hadlock/HC-GA	(11932-1, LN, "HC, Hadlock 1984")

OB/Hadlock/FL-GA	(11920-6, LN, "FL, Hadlock 1984")
OB/Hadlock/CRL-GA	(11910-7, LN, "CRL, Hadlock 1992")
OB/Hansmann/GS-GA	(33105-8, LN, "GS, Hansmann 1979")
OB/Hansmann/BPD-GA	(11903-2, LN, "BPD, Hansmann 1985")
OB/Hansmann/CRL-GA	(11911-5, LN, "CRL, Hansmann 1985")
OB/Hansmann/OFD-GA	(33544-8, LN, "OFD, Hansmann 1985")
OB/Hansmann/HC-GA	(33112-4, LN, "HC, Hansmann 1985")
OB/Hansmann/TAD-GA	(33129-8, LN, "TAD Hansmann, 1979")
OB/Hansmann/ThD-GA	(33136-3, LN, "Transverse Thoracic Diameter, Hansmann")
OB/Hansmann/FL-GA	(11921-4, LN, "FL, Hansmann 1985")
OB/Hansmann/AC-GA	(33073-8, LN, "AC, Hansmann 1985")
OB/Hellman/GS-GA	(11928-9, LN, "GS, Hellman 1969")
OB/Rempen/GS-GA	(11929-7, LN, "GS, Rempen 1991")
OB/Rempen/CRL-GA	(33094-4, LN, "CRL, Rempen 1991")
OB/Rempen/BPD-GA	(33083-7, LN, "BPD, Rempen 1991")
OB/Hill/TCD-GA	(33134-8, LN, "TCD, Hill 1990")
OB/Mercer/Ft-GA	(11926-3, LN, "Foot Length, Mercer 1987")
OB/Kurtz/BPD-GA	(11906-5, LN, "BPD, Kurtz 1980")
OB/Nelson/CRL-GA	(11913-1, LN, "CRL, Nelson 1981")
OB/Robinson/CRL-GA	(11914-9, LN, "CRL, Robinson 1975")
OB/Mayden/OOD-GA	(33124-9, LN, "OOD, Mayden, 1982")
OB/Mayden/IOD-GA	(33122-3, LN, "IOD, Mayden 1982")
OB/Yarkoni/CLA-GA	(33088-6, LN, "Clavical length, Yarkoni 1985")
OB/Osaka/CRL-GA	(33093-6, LN, "CRL, Osaka 1989")
OB/Osaka/BPD-GA	(33082-9, LN, "BPD, Osaka 1989")
OB/Osaka/FL-GA	(33101-7, LN, "FL, Osaka 1989")
OB/Osaka/HL-GA	(33117-3, LN, "Humerus Length, Osaka 1989")
OB/Tokyo/GS-GA	(33108-2, LN, "GS, Tokyo 1986")
OB/Tokyo/CRL-GA	(33096-9, LN, "CRL, Tokyo 1986")
OB/Tokyo/BPD-GA	(33085-2, LN, "BPD, Tokyo 1986")
OB/Tokyo/FL-GA	(33103-3, LN, "FL, Tokyo 1986")
OB/Shinozuka/BPD-GA	(33084-5, LN, "BPD, Shinozuka 1996")
OB/Shinozuka/AC-GA	(33076-1, LN, "AC, Shinozuka 1996")
OB/Shinozuka/FL-GA	(33102-5, LN, "FL, Shinozuka 1996")
OB/Shinozuka/CRL-GA	(33095-1, LN, "CRL, Shinozuka 1996")

xxxiv. GEU Parameter Map from Context ID 12009 Early Gestation Biometry

Name of GEU parameter	Standard Concept Name
CRL	(11957-8, LN, "Crown Rump Length")
GS	(11850-5, LN, "Gestational Sac Diameter")
NT	(33069-6, LN, "Nuchal Translucency")

xxxv. GEU Parameter Map from Context ID 12008 OB-GYN Amniotic Sac

Name of GEU parameter	Measurement Concept Name
AFI1	(11624-4, LN, "First Quadrant Diameter")
AFI2	(11626-9, LN, "Second Quadrant Diameter")
AFI3	(11625-1, LN, "Third Quadrant Diameter")
AFI4	(11623-6, LN, "Fourth Quadrant Diameter")
AFI Sum	(11627-7, LN, "Amniotic Fluid Index")

xxxvi. GEU Parameters Map to Context ID 226 Population Statistical Descriptors

Name of GEU parameter	Base Measurement Concept Name
OB/ASUM/BPD-Min OB/ASUM/AC-Min OB/ASUM2000/BPD-Min OB/ASUM2000/AC-Min OB/Hadlock/BPD-Min OB/Hadlock/AC-Min OB/Hadlock/HC-Min OB/Hadlock/FL-Min OB/Hansmann/BPD-Min OB/Hansmann/CRL-Min OB/Hansmann/OFD-Min OB/Hansmann/HC-Min OB/Hansmann/ThD-Min OB/Hansmann/FL-Min OB/Rempen/GS-Min OB/Mercer/Ft-Min OB/Rempen/CRL-Min	(R-00388, SRT, "2 Sigma Lower Value of population")
OB/ASUM/BPD-Max OB/ASUM/AC-Max OB/ASUM2000/BPD-Max OB/ASUM2000/AC-Max OB/Hadlock/BPD-Max OB/Hadlock/AC-Max OB/Hadlock/HC-Max OB/Hadlock/FL-Max OB/Hansmann/BPD-Max OB/Hansmann/CRL-Max OB/Hansmann/OFD-Max OB/Hansmann/HC-Max OB/Hansmann/ThD-Max OB/Hansmann/FL-Max OB/Rempen/GS-Max OB/Mercer/Ft-Max OB/Rempen/CRL-Max	(R-00387, SRT, "2 Sigma Upper Value of population")
OB/Jeanty/CRL-Min OB/Jeanty/AC-Min OB/Hadlock/CRL-Min OB/Hansmann/TAD-Min OB/Hellman/GS-Min	(R-00347, SRT, "1 Sigma Lower Value of population")
OB/Jeanty/CRL-Max OB/Jeanty/AC-Max OB/Hadlock/CRL-Max OB/Hansmann/TAD-Max OB/Hellman/GS-Max	(R-00346, SRT, "1 Sigma Upper Value of population")
OB/Jeanty/BPD-Min OB/Jeanty/HC-Min OB/Jeanty/FL-Min OB/Jeanty/ULNA-Min OB/Jeanty/HL-Min OB/Jeanty/TIB-Min OB/Merz/BPD-Min OB/Merz/AC-Min OB/Merz/HC-Min OB/Merz/FL-Min	(R-00397, SRT, "5th Percentile Value of population")
OB/Jeanty/BPD-Max OB/Jeanty/HC-Max OB/Jeanty/FL-Max OB/Jeanty/ULNA-Max OB/Jeanty/HL-Max OB/Jeanty/TIB-Max	(R-00337, SRT, "95th Percentile Value of population")

OB/Merz/BPD-Max OB/Merz/AC-Max OB/Merz/HC-Ma OB/Merz/FL-Max	
--	--

xxxvii. GEU Parameters Map to Context ID 12015 Fetal Growth Equations and Tables

Name of GEU parameter	Measurement Concept Name
OB/Jeanty/FIB-GP	(33164-5, LN, "Fibula by GA, Jeanty 1983")
OB/Jeanty/Radius-GP	(33180-1, LN, "OB/Jeanty/Radius-GP")
OB/Merz/BPD-GP	(33154-6, LN, "BPD by GA, Merz 1988")
OB/Merz/AC-GP	(33148-8, LN, "AC by GA, Merz 1988")
OB/Merz/HC-GP	(33176-9, LN, "HC by GA, Merz 1988")
OB/Merz/FL-GP	(33169-4, LN, "FL by GA, Merz 1988")
OB/Hansmann/TTD-GA	(33136-3, LN, "Transverse Thoracic Diameter,
OB/Rempen/GS-GP	(33171-0, LN, "GS by GA, Rempen 1991")
OB/Rempen/CRL-GP	(33160-3, LN, "CRL by GA, Rempen1991")
OB/Rempen/BPD-GP	(33155-3, LN, "BPD by GA, Rempen 1991")
OB/ASUM2000/OFD-GA	(33119-9, LN, "OFD, ASUM 2000")
OB/ASUM2000/CRL-GA	(33090-2, LN, "CRL, ASUM 2000")
OB/ASUM2000/BPD-GA	(33151-2, LN, "BPD, ASUM 2000")
OB/ASUM2000/HC-GA	(33109-0, LN, "HC, ASUM 2000")
OB/ASUM2000/AC-GA	(33072-0, LN, "AC, ASUM 2000")
OB/ASUM2000/HL-GA	(33116-5, LN, "Humerus Length, ASUM 2000")

xxxviii. Context ID 3627 Extended Measurement Types

GEU parameter attribute	Concept Modifier or Has Properties
Aver	(121401, DCM, "Derivation") = (R-00317, SRT, "Mean")
Max	(121401, DCM, "Derivation") = (G-A437, SRT, "Maximum")
Min	(121401, DCM, "Derivation") = (R-404FB, SRT, "Minimum")
Last	(121404, DCM, "Selection Status") = (121411, DCM, "Most recent value chosen")
'C'	(121401, DCM, "Derivation") = (121428, DCM, "Calculated")

xxxix. Miscellaneous GEU Parameters Map to SR Coding Standards

Name of GEU parameter	Measurement Concept Name
GA	(18185-9, LN, Gestational Age)
GP	(125012, DCM, Growth Percentile Rank)
OOR	(114009,DCM, Value out of range)
Side=Rt	(G-A100, SRT, Right)
Side=Lt	(G-A101, SRT, Left)

GEU SR Mapping Table for "Adult Echocardiography Procedure Report
 LOGIQ P6 PRO supports the template TID 5200 for SOP Instances created by this product when exam types selected is Cardiology.

7.8.2 Private Templates

LOGIQ P6 PRO supports the following private templates for SOP Instances created by this product

xl. Private TID GEMS_US_0100 - GE Ultrasound M&A

	NL	Relation with Parent	Value Type	Concept Name	VM	Req Type	Condition	Value Set Constraint
1			CONTAINER	EV (43126, 99GEMS,"Ultrasound M&A Document")	1	M		
	>	CONTAINS	UIDREF	EV (43140, 99GEMS,"Series Instance UID")	1	U		
	>	CONTAINS	TEXT	EV(29463-7, LN,"Patient Weight")	1	U		
	>	CONTAINS	TEXT	EV(8302-2, LN, "Patient Height")	1	U		
	>	CONTAINS	TEXT	EV (43148, 99GEMS, "Ultrasound Category")	1	U		
	>	CONTAINS	TEXT	EV (11878-6, LN, "Number of Fetuses")	1	U		
	>	CONTAINS	TEXT	EV(43139, 99GEMS, "EDD method")	1	U		

7.8.2.1 Template ID GEMS_US_0100 "ultrasound M&A document title"

LOGIQ P6 PRO supports the private template GEMS_US_0100 from the mapping resource 99GEMS.

8. BASIC DIRECTORY INFORMATION OBJECT IMPLEMENTATION

8.1 INTRODUCTION

This section specifies the use of the DICOM Basic Directory IOD to represent the information included in directories produced by this implementation. Corresponding attributes are conveyed using the module construct. The contents of this section are:

8.2 -IOD Implementation

8.3- IOD Module Table

8.4 -IOD Module Definition

8.2 BASIC DIRECTORY IOD IMPLEMENTATION

This section defines the implementation of Basic Directory information object.

8.3 IOD MODULE TABLE

Within an entity of the Basic Directory IOD, attributes are grouped into related set of attributes. A set of related attributes is termed a module. A module facilitates the understanding of the semantics concerning the attributes and how the attributes are related with each other. A module grouping does not infer any encoding of information into datasets.

Table 8.3-1 identifies the defined modules within the entities, which comprise the Basic Directory IOD. Modules are identified by Module Name.

See DICOM Part 3 for a complete definition of the entities, modules, and attributes.

**TABLE 8.3-1
BASIC DIRECTORY IOD MODULES**

Entity Name	Module Name	Reference
File Set Identification	File Set Identification	8.4.1.1
Directory Information	Directory Information	8.4.2.1

The Directory Information Module is created when initializing the media. If it already exists, the existing information is not changed regarding patient, study, series or image/result data.

An existing Directory Information Module may have been obtained from application entities using removable media. These instances are external to this conformance claim and the origin of the SOP instances is outside the scope of this claim.

8.4 INFORMATION MODULE DEFINITIONS

Please refer to DICOM Standard Part 3 (Information Object Definitions) for a description of each of the modules and directory records contained within the Basic Directory Information Object.

The following modules are included to convey Enumerated Values, Defined Terms, and Optional Attributes supported. Type 1 & Type 2 Attributes are also included for completeness and to define what values they may take and where these values are obtained. It should be noted that they are the same ones as defined in the DICOM Standard Part 3

(Information Object Definitions). Not described tag is not supported in LOGIQ P6 PRO.

8.4.1 Common File Set Identification Modules

8.4.1.1 File Set identification Module

Table 8.4-1
FILE-SET IDENTIFICATION MODULE

Attribute Name	Tag	Type	Attribute Description
File-set ID	(0004,1130)	2	Has NULL value
File-set Descriptor File ID	(0004,1141)	3	Not used
Specific Character Set of File-set Descriptor File	(0004,1142)	1C	Not used

8.4.2 Common Directory Information Modules

8.4.2.1 Directory Information Module

Table 8.4-2
DIRECTORY INFORMATION MODULE

Attribute Name	Tag	Type	Attribute Description
Offset of the First Directory Record of the Root Directory Entity	(0004,1200)	1	Is set
Offset of the Last Directory Record of the Root Directory Entity	(0004,1202)	1	Is set
File-set Consistency Flag	(0004,1212)	1	FSC/FSU: Has the value 0000H: no known inconsistencies This flag shall be set by implementations before a File-set update which, if interrupted, may result in an inconsistent File-set.
Directory Record Sequence	(0004,1220)	2	Is created by FSC
>Offset of the Next Directory Record	(0004,1400)	1C	Is set
>Record In-use Flag	(0004,1410)	1C	FSC/FSR: Is set to FFFFH FSR: A value of 0000H: imply skipping this record
>Offset of Referenced Lower-Level Directory Entity	(0004,1420)	1C	Is set
>Directory Record Type	(0004,1430)	1C	The values support by FSC and FSU are PATIENT STUDY SERIES IMAGE SR DOCUMENT
>Private Record UID	(0004,1432)	1C	Not used
>Referenced File ID	(0004,1500)	1C	Is set if Directory Record Type is IMAGE or SR DOCUMENT Contains the file path consisting of 5 elements: 1. "GEMS_IMG" (if IMAGE) or "GEMS_REP" (if SR DOCUMENT)

Attribute Name	Tag	Type	Attribute Description
			2. Month of exam 3. Day of exam 4. Patient initials and time of exam.
>Referenced SOP Class UID in File	(0004,1510)	1C	Is set to the SOP class UID in File. Required if the Directory Record references a SOP Instance.
>Referenced SOP Instance UID in File	(0004,1511)	1C	Is set to the SOP instance UID in File. Required if the Directory Record references a SOP Instance.
>Referenced Transfer Syntax UID in File	(0004,1512)	1C	Is set to the Transfer Syntax UID in File. Required if the Directory Record references a SOP Instance.
>Record Selection Keys			See 8.4.3.

8.4.3 Definition of Specific Directory Records

8.4.3.1 Patient Directory Record Definition

TABLE 8.4-3
PATIENT KEYS

Key	Tag	Type	Attribute Description
Specific Character Set	(0008,0005)	1C	Is filled in by FSC and FSU as in chapter 4, 5, 6 and 7.
Patient's Name	(0010,0010)	2	Is filled in by FSC and FSU as in chapter 4, 5, 6 and 7.
Patient ID	(0010,0020)	1	Is filled in by FSC and FSU as in chapter 4, 5, 6 and 7. If empty, a Patient Id is created by the equipment.
Patient's Birth Date	(0010,0030)	3	Is filled in by FSC and FSU as in chapter 4, 5, 6 and 7.
Patient's Sex	(0010,0040)	3	Is filled in by FSC and FSU as in chapter 4, 5, 6 and 7.
Referenced Patient Sequence	(0008,1120)	3	Is filled in by FSC and FSU as in chapter 4, 5, 6 and 7.
>Referenced SOP Class UID	(0008,1150)	1C	Is filled in by FSC and FSU as in chapter 4, 5, 6 and 7.
>Referenced SOP Instance UID	(0008,1155)	1C	Is filled in by FSC and FSU as in chapter 4, 5, 6 and 7.
Patient's Birth Time	(0010,0032)	3	Is filled in by FSC and FSU as in chapter 4, 5, 6 and 7.
Other Patient Ids	(0010,1000)	3	Is filled in by FSC and FSU as in chapter 4, 5, 6 and 7.
Other Patient Names	(0010,1001)	3	Is filled in by FSC and FSU as in chapter 4, 5, 6 and 7.
Issuer of Patient Identifier	(0010,0021)	3	Is filled in by FSC and FSU as in chapter 4, 5, 6 and 7.
Other Patient IDs Sequence	(0010,1002)	3	Not used
Ethnic Group	(0010,2160)	3	Is filled in by FSC and FSU as in chapter 4, 5, 6 and 7.
Patient Comments	(0010,4000)	3	Is filled in by FSC and FSU as in

Key	Tag	Type	Attribute Description
			chapter 4, 5, 6 and 7.

8.4.3.2 Study Directory Record Definition

**TABLE 8.4-4
STUDY KEYS**

Key	Tag	Type	Attribute Description
Specific Character Set	(0008,0005)	1C	Is filled in by FSC and FSU as in chapter 4, 5, 6 and 7.
Study Instance UID	(0020,000D)	1C	Is filled in by FSC and FSU as in chapter 4, 5, 6 and 7.
Study Date	(0008,0020)	1	Is filled in by FSC and FSU as in chapter 4, 5, 6 and 7. If empty, a Study Date is created by the equipment.
Study Time	(0008,0030)	1	Is filled in by FSC and FSU as in chapter 4, 5, 6 and 7. If empty, a Study Time is created by the equipment.
Referring Physician's Name	(0008,0090)	3	Is filled in by FSC and FSU as in chapter 4, 5, 6 and 7.
Study ID	(0020,0010)	1	Is filled in by FSC and FSU as in chapter 4, 5, 6 and 7. If empty, a Study Id is created by the equipment.
Accession Number	(0008,0050)	2	Is filled in by FSC and FSU as in chapter 4, 5, 6 and 7.
Study Description	(0008,1030)	2	Is filled in by FSC and FSU as in chapter 4, 5, 6 and 7.
Physician(s) of Record	(0008,1048)	3	Is filled in by FSC and FSU as in chapter 4, 5, 6 and 7.
Name of Physician(s) Reading Study	(0008,1060)	3	Is filled in by FSC and FSU as in chapter 4, 5, 6 and 7.
Referenced Study Sequence	(0008,1110)	3	Is filled in by FSC and FSU as in chapter 4, 5, 6 and 7.
>Referenced SOP Class UID	(0008,1150)	1C	Is filled in by FSC and FSU as in chapter 4, 5, 6 and 7.
>Referenced SOP Instance UID	(0008,1155)	1C	Is filled in by FSC and FSU as in chapter 4, 5, 6 and 7.
Admitting Diagnoses Description	(0008,1080)	3	Is filled in by FSC and FSU as in chapter 4, 5, 6 and 7.
Patient's Age	(0010,1010)	3	Is filled in by FSC and FSU as in chapter 4, 5, 6 and 7.
Patient's Size	(0010,1020)	3	Is filled in by FSC and FSU as in chapter 4, 5, 6 and 7.
Patient's Weight	(0010,1030)	3	Is filled in by FSC and FSU as in chapter 4, 5, 6 and 7.
Occupation	(0010,2180)	3	Is filled in by FSC and FSU as in chapter 4, 5, 6 and 7.
Additional Patient's History	(0010,21B0)	3	Is filled in by FSC and FSU as in chapter 4, 5, 6 and 7.

8.4.3.3 Series Directory Record Definition

TABLE 8.4-5
SERIES KEYS

Key	Tag	Type	Attribute Description
Specific Character Set	(0008,0005)	1C	Is filled in by FSC or FSU as contained in the image or SR document message, if one of the tags contains extended characters
Modality	(0008,0060)	1	Is filled in by FSC and FSU as in chapter 4, 5, 6 and 7.
Series Instance UID	(0020,000E)	1	Is filled in by FSC and FSU as in chapter 4, 5, 6 and 7.
Series Number	(0020,0011)	1	Is filled in by FSC and FSU as in chapter 4, 5, 6 and 7. If empty, a Series Number is created by the equipment.
Icon Image Sequence	(0088,0200)	3	Not used.
Series Date	(0008,0021)	3	Is filled in by FSC and FSU as in chapter 4, 5, 6 and 7 if instance is IMAGE.
Series Time	(0008,0031)	3	Is filled in by FSC and FSU as in chapter 4, 5, 6 and 7 if instance is IMAGE.
Performing Physicians' Name	(0008,1050)	3	Is filled in by FSC and FSU as in chapter 4, 5, 6 and 7 if instance is IMAGE.
Protocol Name	(0018,1030)	3	Is filled in by FSC and FSU as in chapter 4, 5, 6 and 7 if instance is IMAGE.
Series Description	(0008,103E)	3	Is filled in by FSC and FSU as in chapter 4, 5, 6 and 7 if instance is IMAGE.
Operator's Name	(0008,1070)	3	Is filled in by FSC and FSU as in chapter 4, 5, 6 and 7 if instance is IMAGE.
Referenced Performed Procedure Step Sequence	(0008,1111)	3	Is filled in by FSC and FSU as in chapter 4, 5, 6 and 7.
>Referenced SOP Class UID	(0008,1150)	1C	Is filled in by FSC and FSU as in chapter 4, 5, 6 and 7.
>Referenced SOP Instance UID	(0008,1155)	1C	Is filled in by FSC and FSU as in chapter 4, 5, 6 and 7.
Request Attributes Sequence	(0040,0275)	3	Is filled in by FSC and FSU as in chapter 4, 5, 6 and 7 if instance is IMAGE.
>Requested Procedure ID	(0040,1001)	1C	Is filled in by FSC and FSU as in chapter 4, 5, 6 and 7 if instance is IMAGE.
>Scheduled Procedure Step ID	(0040,0009)	1C	Is filled in by FSC and FSU as in chapter 4, 5, 6 and 7 if instance is IMAGE.
>Scheduled Procedure Step Description	(0040,0007)	3	Is filled in by FSC and FSU as in chapter 4, 5, 6 and 7 if instance is IMAGE.
>Scheduled Protocol Code Sequence	(0040,0008)	3	Is filled in by FSC and FSU as in chapter 4, 5, 6 and 7 if instance is IMAGE.
>>Include 'Code Sequence Macro'			Is filled in by FSC and FSU as in chapter 4, 5, 6 and 7 if instance is

Key	Tag	Type	Attribute Description
			IMAGE.
Performed Procedure Step ID	(0040,0253)	3	Is filled in by FSC and FSU as in chapter 4, 5, 6 and 7 if instance is IMAGE.
Performed Procedure Step Start Date	(0040,0244)	3	Is filled in by FSC and FSU as in chapter 4, 5, 6 and 7 if instance is IMAGE.
Performed Procedure Step Start Time	(0040,0245)	3	Is filled in by FSC and FSU as in chapter 4, 5, 6 and 7 if instance is IMAGE.
Performed Procedure Step Description	(0040,0254)	3	Is filled in by FSC and FSU as in chapter 4, 5, 6 and 7 if instance is IMAGE.
Performed Protocol Code Sequence	(0040,0260)	3	Is filled in by FSC and FSU as in chapter 4, 5, 6 and 7 if instance is IMAGE.
>Include 'Code Sequence Macro'			
Manufacturer	(0008,0070)	2	Is filled in by FSC and FSU as in chapter 4, 5, 6 and 7.
Institution Name	(0008,0080)	3	Is filled in by FSC and FSU as in chapter 4, 5, 6 and 7.
Station Name	(0008,1010)	3	Is filled in by FSC and FSU as in chapter 4, 5, 6 and 7.
Institutional Department Name	(0008,1040)	3	Is filled in by FSC and FSU as in chapter 4, 5, 6 and 7.
Manufacturer's Model Name	(0008,1090)	3	Is filled in by FSC and FSU as in chapter 4, 5, 6 and 7.
Software Versions	(0018,1020)	3	Is filled in by FSC and FSU as in chapter 4, 5, 6 and 7.

8.4.3.4 Image Directory Record Definition

TABLE 8.4-6
IMAGE KEYS

Key	Tag	Type	Attribute Description
Specific Character Set	(0008,0005)	1C	Is filled in by FSC and FSU as in chapter 4, 5 and 6.
Instance Number	(0020,0013)	1	Is filled in by FSC and FSU as in chapter 4, 5 and 6. If empty, a Instance Number is created by the equipment.
Icon Image Sequence	(0088,0200)	3	Not used
Content Date	(0008,0023)	3	Is filled in by FSC and FSU as in chapter 4, 5 and 6.
Content Time	(0008,0033)	3	Is filled in by FSC and FSU as in chapter 4, 5 and 6.
Image Type	(0008,0008)	3	Is filled in by FSC and FSU as in chapter 4, 5 and 6.
Rows	(0028,0010)	3	Is filled in by FSC and FSU as in chapter 4, 5 and 6.
Columns	(0028,0011)	3	Is filled in by FSC and FSU as in chapter 4, 5 and 6.
Number Of Frames	(0028,0008)	3	Is filled in by FSC and FSU as in chapter 4, 5 and 6.
Photometric Interpretation	(0028,0004)	3	Is filled in by FSC and FSU as in chapter 4, 5 and 6.
Contrast/Bolus Agent	(0018,0010)	2	Is filled in by FSC and FSU as in

Key	Tag	Type	Attribute Description
			chapter 4, 5 and 6.
Lossy Image Compression	(0028,2110)	3	Is filled in by FSC and FSU as in chapter 4, 5 and 6.
Lossy Image Compression Ratio	(0028,2112)	3	Is filled in by FSC and FSU as in chapter 4, 5 and 6.

8.4.3.5 SR Document Record Definition

TABLE 8.4-7
SR DOCUMENT KEYS

Key	Tag	Type	Attribute Description
Specific Character Set	(0008,0005)	1C	Is filled in by FSC and FSU as in chapter 7.
Instance Number	(0020,0013)	1	Is filled in by FSC and FSU as in chapter and 7. If empty, a Instance Number is created by the equipment.
Content Date	(0008,0023)	1	Is filled in by FSC and FSU as in chapter 7.
Content Time	(0008,0033)	1	Is filled in by FSC and FSU as in chapter 7.
Completion Flag	(0040,A491)	1	Is filled in by FSC and FSU as in chapter 7.
Verification Flag	(0040,A493)	1	Is filled in by FSC and FSU as in chapter 7.
Concept Name Code Sequence	(0040,A043)	1	Is filled in by FSC and FSU as in chapter 7.
Content Sequence	(0040,A730)	1C	Is filled in by FSC and FSU as in chapter 7.

8.4.3.6 Private Directory Record Definition

Not used

8.5 PRIVATE DATA DICTIONARY

If so configured, the product will send ultrasound raw data information in private data elements designated by the Private Creator element:

Element Name	TAG	VR	VM	Description
Private Creator	7FE1,00xx	LO	1	GEMS_Ultrasound_MovieGroup_001

This means that all private tags starting with 7FE1,xx will belong to the GEMS_Ultrasound_MovieGroup_001.

If so configured, the product will send preview image in private data elements designated by the Private Creator element:

Element Name	TAG	VR	VM	Description
Private Creator	6003,00xx	LO	1	GEMS_Ultrasound_ImageGroup_001

This means that all private tags starting with 6003,xx will belong to the GEMS_Ultrasound_ImageGroup_001.

9. MODALITY WORKLIST INFORMATION MODEL DEFINITION

9.1 INTRODUCTION

This section specifies the use of the DICOM Modality Worklist Information Model used to organize data and against which a Modality Worklist Query will be performed. The contents of this section are:

9.2- Information Model Description

9.3- Information Model Entity-Relationship Model

9.4- Information Model Module Table

9.5- Information Model Keys

9.2 MODALITY WORKLIST INFORMATION MODEL DESCRIPTION

This section defines the implementation of Modality Worklist Information Model.

9.3 MODALITY WORKLIST INFORMATION MODEL ENTITY-RELATIONSHIP MODEL

The Entity-Relationship diagram for the Modality Worklist Information Model schema is shown in Illustration 9.3-1. It represents the information that composes a Worklist Item. In this figure, the following diagrammatic convention is established to represent the information organization:

- Each entity is represented by a rectangular box.
- Each relationship is represented by a diamond shaped box.
- The fact that a relationship exists between two entities is depicted by lines connecting the corresponding entity boxes to the relationship boxes.
- In the event that a duplicate Study Instance UID is received, only the last record of the duplicate will be displayed.

ILLUSTRATION 9.3-1
MODALITY WORKLIST INFORMATION MODEL E/R DIAGRAM

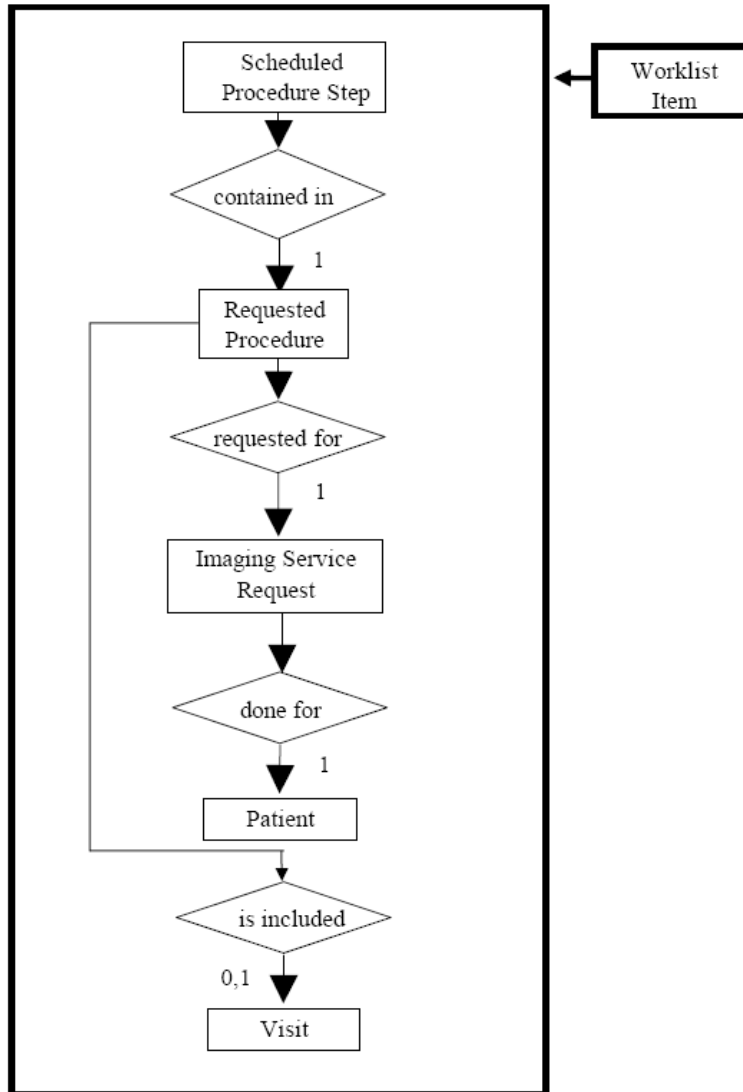

9.3.1 Entity Descriptions

Please refer to DICOM Standard PS 3.3. (Information Object Definitions) and PS 3.4 (Service Class Specifications) for a description of each of the Entities contained within the Modality Worklist Information Model.

9.3.1.1 Scheduled Procedure Step

Schedule Procedure Step is implemented in a basic form to allow for the user to retrieve a subset of attributes.

9.3.1.2 Requested Procedure Entity Description

Requested Procedure Step is implemented in a basic form to allow for the user to retrieve a subset of attributes.

9.3.1.3 Imaging Service Request Entity Description

Image Service is implemented in a basic form to allow for the user to retrieve a subset of attributes.

9.3.1.4 Visit Entity Description

Visit Entity is implemented in a basic form to allow for the user to retrieve a subset of attributes.

9.3.1.5 Patient Entity Description

Patient Entity Description is implemented in a basic form to allow for the user to retrieve a subset of attributes.

9.3.2 LOGIQ P6 PRO Mapping of DICOM entities

TABLE 9.3-1
MAPPING OF DICOM ENTITIES TO LOGIQ P6 PRO ENTITIES

DICOM	LOGIQ P6 PRO Entity
Scheduled Procedure Step	Not Applicable
Requested Procedure	Exam
Imaging Service Request	Exam
Visit	Not Applicable
Patient	Patient

9.4 INFORMATION MODEL MODULE TABLE

Within an entity of the DICOM Modality Worklist Information Model, attributes are grouped into related set of attributes. A set of related attributes is termed a module. A module facilitates the understanding of the semantics concerning the attributes and how the attributes are related with each other. A module grouping does not infer any encoding of information into datasets.

Table 9.4-1 identifies the defined modules within the entities that comprise the DICOM Modality Worklist Information Model. Modules are identified by Module Name.

See DICOM PS 3.3 and PS 3.4 for a complete definition of the entities, modules, and attributes.

TABLE 9.4-1
MODALITY WORKLIST INFORMATION MODEL MODULES

Entity Name	Module Name	Reference
Scheduled Procedure Step	SOP Common	9.5.2.1
	Scheduled Procedure Step	9.5.2.2
Requested Procedure	Requested Procedure	9.5.3.1
Imaging Service Request	Imaging Service Request	9.5.4.1
Visit	Visit Identification	9.5.5.1
	Visit Status	9.5.5.2
	Visit Relationship	9.5.5.3
	Visit Admission	Not Used
Patient	Patient Relationship	Not Used
	Patient Identification	9.5.6.1
	Patient Demographic	9.5.6.2
	Patient Medical	9.5.6.3

9.5 INFORMATION MODEL KEYS

Please refer to DICOM Standard PS 3.3. (Information Object Definitions) and PS 3.4 (Service Class Specifications) for a description of each of the Entities contained within the Modality Worklist Information Model.

The following Module descriptions are included to specify what data elements are supported and what type of matching can be applied. It should be noted that they are the same ones as defined in the DICOM Standard PS 3.4 (Service Class Specifications).

The term Instance is used for Images and Results in examinations that are based on Worklist entries.

9.5.1 Supported Matching

Following are the types of matching that can be requested by the implementation:

- Universal Value Matching (default) (U).
- Single Value Matching(S)
- Wild Card Matching(*)
- Range of date, Range of Time(R)

Fields with “Matching is supported” from the Notes column in Table 9-4 to 9-12 means that user can access configuration to match type which is supported above when appropriate. When user doesn’t add new or configure matching, the default is ‘Universal Matching’

Fields with “Filtering is supported” in the Matching column can be controlled from the Search screen.

All non-required matching fields can be configured in Config screen to be either enabled, enabled with a constant value or disabled. The constant value will be used as entered by user. Returned values, particularly those not mapped into the images or MPPSs, are viewable by the user by using the “DICOM Properties” button in the user interface.

9.5.2 Scheduled Procedure Step Entity

9.5.2.1 SOP Common Module

TABLE 9.5-1
SOP COMMON MODULE ATTRIBUTES

Attribute Name	Tag	Expected Matching Key Type	Expected Returned Key Type	Mapped into Instance/MPPS	Matching
Specific Character Set	(0008,0005)	O	1C	Yes/Yes	Attribute is supported if the query contains matching keys in other than the default character repertoire. ISO_IR 100 is supported in responses.

9.5.2.2 Scheduled Procedure Step Module

TABLE 9.5-2
SCHEDULED PROCEDURE STEP MODULE ATTRIBUTES

Attribute Name	Tag	Expected Matching Key Type	Expected Returned Key Type	Mapped into Instance/MPPS	Matching
----------------	-----	----------------------------	----------------------------	---------------------------	----------

Scheduled Procedure Step Sequence	(0040,0100)	R	1	No/No	U - Matching is supported.
>Scheduled Station AE Title	(0040,0001)	R	1	No/No	U - Matching is supported.
>Scheduled Procedure Step Start Date	(0040,0002)	R	1	No/No	R - Matching is supported. Filtering is supported.
>Scheduled Procedure Step Start Time	(0040,0003)	R	1	No/No	R - Matching is supported.
>Modality	(0008,0060)	R	1	Yes/Yes (but always "US")	U - Matching is supported.
>Scheduled Performing Physician's Name	(0040,0006)	R	2	Yes/Yes (to Performing Physician's Name)	*, U - Matching is supported.
>Scheduled Procedure Step Description	(0040,0007)	O	1C	Yes/Yes	U - Matching is supported.
>Scheduled Station Name	(0040,0010)	O	2	No/No	U - Matching is supported.
>Scheduled Procedure Step Location	(0040,0011)	O	2	No/No	U - Matching is supported.
>Scheduled Procedure Step ID	(0040,0009)	O	1	Yes/Yes	U - Matching is supported.
>Scheduled Protocol Code Sequence	(0040,0008)	O	1C	Yes/Yes	U - Matching is supported.

9.5.3 Requested Procedure Entity

9.5.3.1 Requested Procedure Module

TABLE 9.5-3
REQUESTED PROCEDURE MODULE ATTRIBUTE

Attribute Name	Tag	Expected Matching Key Type	Expected Returned Key Type	Mapped into Instance/MPPS	Matching
Requested Procedure ID	(0040,1001)	O	1	Yes/Yes (to Requested Procedure ID and Study ID)	U - Matching is supported. Filtering is supported.
Requested Procedure Description	(0032,1060)	O	1C	Yes/Yes (to Study Description and Requested Procedure Description)	U - Matching is supported.
Requested	(0032,1064)	O	1C	No/Yes	U - Matching is supported.

Attribute Name	Tag	Expected Matching Key Type	Expected Returned Key Type	Mapped into Instance/MPPS	Matching
Procedure Code Sequence					
Requested Procedure Comments	(0040,1400)	O	3	No/No	U - Matching is supported.
Study Instance UID	(0020,000D)	O	1	Yes/Yes	UNIQUE - Matching is supported.
Referenced Study Sequence	(0008,1110)	O	2	Yes/Yes	U - Matching is supported.
>Referenced SOP Class UID	(0008,1150)	O	1C	Yes/Yes	UNIQUE - Matching is supported.
>Referenced SOP Instance UID	(0008,1155)	O	1C	Yes/Yes	UNIQUE - Matching is supported.
Names of Intended Recipients of Results	(0040,1010)	O	3	Yes/No (to Physician(s) of Record)	U - Matching is supported

9.5.4 Imaging Service Request Entity

9.5.4.1 Imaging Service Request Module

TABLE 9.5-4
IMAGING SERVICE REQUEST MODULE ATTRIBUTES

Attribute Name	Tag	Expected Matching Key Type	Expected Returned Key Type	Mapped into Instance/MPPS	Matching
Accession Number	(0008,0050)	O	2	Yes/Yes	*, S, U - Matching is supported. Filtering is supported.
Referring Physician's Name	(0008,0090)	O	2	Yes/No	*, U - Matching is supported.
Imaging Service Request Comments	(0040,2400)	O	3	No/No	U - Matching is supported.
Requesting Physician	(0032,1032)	O	2	No/No	U - Matching is supported.
Requesting Service	(0032,1033)	O	3	No/No	U - Matching is supported.

9.5.5 Visit Entity

9.5.5.1 Visit Identification

TABLE 9.5-5
VISIT IDENTIFICATION MODULE ATTRIBUTES

Attribute Name	Tag	Expected Matching	Expected Returned	Mapped into Instance/MPPS	Matching
----------------	-----	-------------------	-------------------	---------------------------	----------

		Key Type	Key Type		
Admission ID	(0038,0010)	O	2	No/No	*, U - Matching is supported.

9.5.5.2 Visit Status

TABLE 9.5-6
VISIT STATUS MODULE ATTRIBUTES

Attribute Name	Tag	Expected Matching Key Type	Expected Returned Key Type	Mapped into Instance/MPPS	Matching
Current Patient Location	(0038,0300)	O	2	No/No	U - Matching is supported.

9.5.5.3 Visit Relationship

TABLE 9.5-7
VISIT RELATIONSHIP MODULE ATTRIBUTES

Attribute Name	Tag	Expected Matching Key Type	Expected Returned Key Type	Mapped into Instance/MPPS	Matching
Referenced Patient Sequence	(0008,1120)	O	2	Yes/Yes	Matching is supported.
>Referenced SOP Class UID	(0008,1150)	O	2	Yes/Yes	UNIQUE - Matching is supported.
>Referenced SOP Instance UID	(0008,1155)	O	2	Yes/Yes	UNIQUE - Matching is supported.

9.5.6 Patient Entity

9.5.6.1 Patient Identification

TABLE 9.5-8
PATIENT IDENTIFICATION MODULE ATTRIBUTES

Attribute Name	Tag	Expected Matching Key Type	Expected Returned Key Type	Mapped into Instance/MPPS	Matching
Patient's Name	(0010,0010)	R	1	Yes/Yes	*, U - Matching is supported. Filtering is supported, except Date Range
Patient ID	(0010,0020)	R	1	Yes/Yes	*, U - Matching is supported. Filtering is supported, except Date Range and Wild Char.
Other Patient Ids	(0010,1000)	O	3	Yes/No	*, U - Matching is supported.
Issuer of Patient Identifier	(0010,0021)	O	3	Yes/No	*, U - Matching is supported.

9.5.6.2 Patient Demographic

TABLE 9.5-9
PATIENT DEMOGRAPHIC MODULE ATTRIBUTES

Attribute Name	Tag	Expected Matching Key Type	Expected Returned Key Type	Mapped into Instance/MPPS	Matching
Patients Birth Date	(0010,0030)	O	2	Yes/Yes	R - Matching is supported. Filtering is supported.
Patients Birth Time	(0010,0032)	O	3	Yes/No	R - Matching is supported.
Patient's Sex	(0010,0040)	O	2	Yes/Yes	S, U - Matching is supported Filtering is supported.
Patient's Size	(0010,1020)	O	3	Yes/No	U - Matching is supported.
Patient's Weight	(0010,1030)	O	2	Yes/No	U - Matching is supported.
Ethnic Group	(0010,2160)	O	3	Yes/No	U - Matching is supported.
Patient Comments	(0010,4000)	O	3	Yes/No	U - Matching is supported.

9.5.6.3 Patient Medical

TABLE 9.5-10
PATIENT MEDICAL MODULE ATTRIBUTES

Attribute Name	Tag	Expected Matching Key Type	Expected Returned Key Type	Mapped into Instance/MPPS	Matching
Additional Patient History	(0010,21B0)	O	3	Yes/No	U - Matching is supported.
Contrast Allergies	(0010,2210)	O	2	No/No	U - Matching is supported.
Medical Alerts	(0010,2000)	O	2	No/No	U - Matching is supported.
Pregnancy Status	(0010,21C0)	O	2	No/No	U - Matching is supported.

10. MODALITY PERFORMED PROCEDURE STEP SOP CLASS DEFINITION

10.1 INTRODUCTION

This section of the DICOM Conformance Statement specifies the Modality Performed Procedure Step SOP Class, the optional attributes and service elements supported, the valid range of values for mandatory and optional attributes, and the status code behavior.

10.2 MODALITY PERFORMED PROCEDURE STEP SOP CLASS DEFINITION

In this section, supported means that tag is sent with value if entered by user or from worklist.

10.2.1 IOD Description

This is the description of the DICOM tags to be sent for Modality Performed Procedure Step SOP class:

Modality Performed Procedure Step Sop Class N-CREATE, N-SET and Final State Attributes

Attribute Name	Tag	Req. Type N-CREATE	Req. Type N-SET
Performed Procedure Step Relationship			
Scheduled Step Attribute Sequence	(0040,0270)	1	Not allowed
>Study Instance UID	(0020,000D)	1	Not allowed
>Referenced Study Sequence	(0008,1110)	2, supported	Not allowed
>>Referenced SOP Class UID	(0008,1150)	1C, supported	Not allowed
>>Referenced SOP Instance UID	(0008,1155)	1C, supported	Not allowed
>Accession Number	(0008,0050)	2, supported	Not allowed
>Placer Order Number/Imaging Service Request	(0040,2016)	3, not supported	Not allowed
>Filler Order Number/Imaging Service Request	(0040,2017)	3, not supported	Not allowed
>Requested Procedure ID	(0040,1001)	2, supported	Not allowed
>Requested Procedure Description	(0032,1060)	2, supported	Not allowed
>Scheduled Procedure Step ID	(0040,0009)	2, supported	Not allowed
>Scheduled Procedure Step Description	(0040,0007)	2, supported	Not allowed
>Scheduled Protocol Code Sequence	(0040,0008)	2, supported	Not allowed
>>Include 'Code Sequence Macro'			
Patient's Name	(0010,0010)	2, supported	Not allowed
Patient ID	(0010,0020)	2, supported	Not allowed
Patient's Birth Date	(0010,0032)	2, supported	Not allowed
Patient's Sex	(0010,0040)	2, supported	Not allowed
Referenced Patient Sequence	(0008,1120)	2, supported	Not allowed
>Referenced SOP Class UID	(0008,1150)	1C, supported	Not allowed
>Referenced SOP Instance UID	(0008,1155)	1C, supported	Not allowed
Performed Procedure Step Information			
Performed Procedure Step ID	(0040,0253)	1	Not allowed
Performed Station AE Title	(0040,0241)	1	Not allowed
Performed Station Name	(0040,0242)	2, supported	Not allowed
Performed Location	(0040,0243)	2, supported (Institution Name, truncated if necessary to 16	Not allowed

Attribute Name	Tag	Req. Type N-CREATE	Req. Type N-SET
		characters)	
Performed Procedure Step Start Date	(0040,0244)	1	Not allowed
Performed Procedure Step Start Time	(0040,0245)	1	Not allowed
Performed Procedure Step Status	(0040,0252)	1	3, supported
Performed Procedure Step Description	(0040,0254)	2, supported	3, supported
Performed Procedure Type Description	(0040,0255)	2, always empty	3, always empty
Procedure Code Sequence	(0008,1032)	2, supported	3, supported
>Include 'Code Sequence Macro'			
Performed Procedure Step End Date	(0040,0250)	2, always empty	3, supported
Performed Procedure Step End Time	(0040,0251)	2, always empty	3, supported
Performed Procedure Step Discontinuation Reason Code Sequence	(0040,0281)	Not supported	Not allowed
Image Acquisition Results			
Modality	(0008,0060)	1	Not allowed
Study ID	(0020,0010)	2, supported	Not allowed
Performed Protocol Code Sequence	(0040,0260)	2, always empty	3, always empty
>Include 'Code Sequence Macro'			
Performed Series Sequence	(0040,0340)	2, always empty (null)	3, supported
>Performing Physician's Name	(0008,1050)	Not supported	2C, supported (Required if Sequence Item is present)
>Protocol Name	(0018,1030)	Not supported	1C (Required if Sequence Item is present)
>Operator's Name	(0008,1070)	Not supported	2C, supported (Required if Sequence Item is present)
>Series Instance UID	(0020,000E)	Not supported	1C (Required if Sequence Item is present)
>Series Description	(0008,103E)	Not supported	2C, always empty (null) (Required if Sequence Item is present)
>Retrieve AE Title	(0008,0054)	Not supported	2C, always empty (null) (Required if Sequence Item is present)
>Referenced Image Sequence	(0008,1140)	Not supported	2C, supported (Required if Sequence Item is present)
>>Referenced SOP Class UID	(0008,1150)	Not supported	1C (Required if Sequence Item is present)
>>Referenced SOP Instance UID	(0008,1155)	Not supported	1C (Required if Sequence Item is present)
>Referenced Non-Image Composite SOP Instance Sequence	(0040,0220)	2C (Required if Sequence Item is present)	Is set when there is SR generated with images.
>>Referenced SOP Class UID	(0008,1150)	1C	Is set to SR's SOP Class

Attribute Name	Tag	Req. Type N-CREATE	Req. Type N-SET
		(Required if Sequence Item is present)	UID
>>Referenced SOP Instance UID	(0008,1155)	1C (Required if Sequence Item	Is set to SR's SOP Class UID

10.2.2 Operations

Action Information

Covered under IOD Description in Section 10.2.1

10.2.2.1 Service Class User Behavior

LOGIQ P6 PRO sends N-CREATE when first image in examination is acquired or when the exam is ended for the case where there are no images.

LOGIQ P6 PRO sends N-SET after the exam is ended. The N-SET will include all acquired images' and reports' UIDs and the status of COMPLETED or DISCONTINUED.

10.2.2.2 Status Codes

Please refer section 2.3.1.2.4.2.1 for a description of status codes.

11. STORAGE COMMITMENT PUSH MODEL SOP CLASS DEFINITION

11.1 INTRODUCTION

This section of the DICOM Conformance Statement specifies the Storage Commitment Push Model SOP Class, the optional attributes and service elements supported, the valid range of values for mandatory and optional attributes, and the status code behavior.

11.2 STORAGE COMMITMENT PUSH MODEL SOP CLASS DEFINITION

11.2.1 IOD Description

11.2.1.1 STORAGE COMMITMENT MODULE

TABLE 11.2-1
STORAGE COMMITMENT MODULE

Attribute Name	Tag	Attribute Description
Transaction UID	(0008,1195)	Uniquely generated by the equipment
Retrieve AE Title	(0008,0054)	Not used
Storage Media File-Set ID	(0088,0130)	Not used
Storage Media File-Set UID	(0088,0140)	Not used
Referenced SOP Sequence	(0008,1199)	Supported
>Referenced SOP Class UID	(0008,1150)	Supported
>Referenced SOP Instance UID	(0008,1155)	Supported
>Retrieve AE Title	(0008,0054)	Not used
>Storage Media File-Set ID	(0088,0130)	Not used
>Storage Media File-Set UID	(0088,0140)	Not used
Failed SOP Sequence	(0008,1198)	Supported
>Referenced SOP Class UID	(0008,1150)	Supported
>Referenced SOP Instance UID	(0008,1155)	Supported
>Failure Reason	(0008,1197)	Supported

11.2.2 DIMSE Service Group

DIMSE Service Element	Usage SCU/SCP
N-EVENT-REPORT	M/M
N-ACTION	M/M

11.2.3 Operations

11.2.3.1 Action Information

TABLE 11.2-2
STORAGE COMMITMENT REQUEST – ACTION INFORMATION

Action Type Name	Action Type ID	Attribute	Tag	Requirement Type SCU/SCP
Request Storage Commitment	1	Transaction UID	(0008,1195)	1/1
		Storage Media File- Set ID	(0088,0130)	Not used
		Storage Media File- Set UID	(0088,0140)	Not used
		Referenced SOP Sequence	(0008,1199)	1/1
		>Referenced SOP Class UID	(0008,1150)	1/1
		>Referenced SOP Instance UID	(0008,1155)	1/1
		>Storage Media File- Set ID	(0088,0130)	Not used
		>Storage Media File- Set UID	(0088,0140)	Not used

11.2.3.2 Service Class User Behavior

LOGIQ P6 PRO sends the N-ACTION primitive (Storage Commitment Request) after successful exam save to a DICOM Storage SCP.

LOGIQ P6 PRO may request storage commitment for all generated SOP Class UIDs:

Ultrasound Multi-frame Image Storage	1.2.840.10008.5.1.4.1.1.3.1
Ultrasound Multi-frame Image Storage (Retired)	1.2.840.10008.5.1.4.1.1.3
Ultrasound Image Storage	1.2.840.10008.5.1.4.1.1.6.1
Ultrasound Image Storage (Retired)	1.2.840.10008.5.1.4.1.1.6
Secondary Capture Image Storage	1.2.840.10008.5.1.4.1.1.7

The association for the N-ACTION is disconnected after processing the response. Thus, the N-EVENT- REPORT must be sent on a separate association.

The Referenced Study Component Sequence Attribute is not supported.

The Transaction UID is valid for two days. If no answer is received, the request will be removed without warning the user. The optional Storage Media File-Set ID & UID Attributes in the N-ACTION are not supported. On receipt of an unsuccessful N-ACTION Response Status Code from the SCP, the request will be put in a holding queue for the user to manually retry the request

11.2.3.3 Status Codes

Please refer section 2.3.1.2.1.2.1 for a description of status codes.

11.2.4 Notifications

LOGIQ P6 PRO will only listen for an N-EVENT-REPORT from the SCP in a new association on the listen port for Verification and Storage Commitment.

11.2.4.1 Event Information

TABLE 11.2-3
STORAGE COMMITMENT RESULT - EVENT INFORMATION

Event Type Name	Event Type ID	Attribute	Tag	Requirement Type SCU/SCP
Storage Commitment Request Successful	1	Transaction UID	(0008,1195)	-/1
		Retrieve AE Title	(0008,0054)	Not used

		Storage Media File-Set ID	(0088,0130)	Not used
		Storage Media File-Set UID	(0088,0140)	Not used
		Referenced SOP Sequence	(0008,1199)	-/1
		>Referenced SOP Class UID	(0008,1150)	-/1
		>Referenced SOP Instance UID	(0008,1155)	-/1
		>Retrieve AE Title	(0008,0054)	Not used
		>Storage Media File-Set ID	(0088,0130)	Not used
		>Storage Media File-Set UID	(0088,0140)	Not used
Storage Commitment Request Complete - Failures Exist	2	Transaction UID	(0008,1195)	-/1
		Retrieve AE Title	(0008,0054)	Not used
		Storage Media File-Set ID	(0088,0130)	Not used
		Storage Media File-Set UID	(0088,0140)	Not used
		Referenced SOP Sequence	(0008,1199)	-/1C
		>Referenced SOP Class UID	(0008,1150)	-/1
		>Referenced SOP Instance UID	(0008,1155)	-/1
		>Retrieve AE Title	(0008,0054)	Not used
		>Storage Media File-Set ID	(0088,0130)	Not used
		>Storage Media File-Set UID	(0088,0140)	Not used
		Failed SOP Sequence	(0008,1198)	-/1
		>Referenced SOP Class UID	(0008,1150)	-/1
		>Referenced SOP Instance UID	(0008,1155)	-/1
		>Failure Reason	(0008,1197)	-/1

11.2.4.2 Service Class User Behavior

If a successful answer is received, the request will be removed automatically without warning the user. If a non-successful answer is received, the request will be left in the holding queue.

If no answer is received, the request will be removed without warning the user after two days.

11.2.4.3 Status Codes

Please refer section 2.3.1.3.3.2.1 for a description of status codes.

12. PRINT MANAGEMENT SOP CLASS DEFINITION

12.1 INTRODUCTION

This section of the DICOM Conformance Statement specifies the supported Print Management SOP and Meta SOP Classes, the optional attributes and service elements supported, the valid range of values for mandatory and optional attributes, and the status code behavior.

12.2 - Basic Print Management Meta SOP Classes

12.3 - Print Management SOP Class Definitions

12.4 - Print Management IODs

12.5 - IOD Module Definition

12.2 BASIC PRINT MANAGEMENT META SOP CLASSES

The Basic Print Management Meta SOP Classes correspond with the minimum functionality that an implementation of the Print Management Service Class shall support.

LOGIQ P6 PRO supports the Basic Grayscale Print Management Meta SOP Class and the Basic Color Print Management Meta SOP Class. These are defined in Table 12.2.1-1 and Table 12.2.2-1.

12.2.1 Basic Grayscale Print Management Meta SOP Class

The Basic Grayscale Print Management Meta SOP Class is defined by the following set of supported SOP Classes.

TABLE 12.2.1-1 BASIC GRAYSCALE PRINT MANAGEMENT META SOP CLASS

SOP Class Name	Usage SCU	Reference
Basic Film Session SOP Class	M	see 12.3.1
Basic Film Box SOP Class	M	see 12.3.2
Basic Grayscale Image Box SOP Class	M	see 12.3.3.1
Printer SOP Class	M	see 12.3.4

12.2.2 Basic Color Print Management Meta SOP Class

The Basic Color Print Management Meta SOP Class is defined by the following set of supported SOP Classes.

TABLE 12.2.2-1 BASIC COLOR PRINT MANAGEMENT META SOP CLASS

SOP Class Name	Usage SCU	Reference
Basic Film Session SOP Class	M	see 12.3.1
Basic Film Box SOP Class	M	see 12.3.2
Basic Color Image Box SOP Class	M	see 12.3.3.2
Printer SOP Class	M	see 12.3.4

12.3 PRINT MANAGEMENT SOP CLASS DEFINITIONS

12.3.1 Basic Film Session SOP Class

The Basic Film Session IOD describes the presentation parameters, which are common for all the films of a film session. The DIMSE services that are applicable to the IOD are shown in Table 12.3.1-1.

TABLE 12.3.1-1 DIMSE SERVICE GROUP

SOP Class Name	Usage SCU	Reference
N-CREATE	M	see 12.3.1.1.1
N-SET	U	see 12.3.1.1.2
N-DELETE	U	see 12.3.1.1.3
N-ACTION	U	see 12.3.1.1.4

12.3.1.1 DIMSE Service Group

12.3.1.1.1 N-CREATE

The N-CREATE DIMSE Service is used by LOGIQ P6 PRO to request that the SCP (printer) create a Film Session SOP Instance. Table 12.4.1-1 defines the Basic Film Session Presentation Module attributes used in this request.

12.3.1.1.2 N-SET

Not used in this implementation.

12.3.1.1.3 N-DELETE

Not used in this implementation.

12.3.1.1.4 N-ACTION

Not used in this implementation

12.3.2 Basic Film Box SOP Class

The Basic Film Box IOD is an abstraction of the presentation of one film of the film session. The DIMSE services that are applicable to the IOD are shown in Table 12.3.2-1.

TABLE 12.3.2-1 DIMSE SERVICE GROUP

SOP Class Name	Usage SCU	Reference
N-CREATE	M	see 12.3.2.1.1
N-ACTION	M	see 12.3.2.1.2
N-DELETE	U	see 12.3.2.1.3
N-SET	U	see 12.3.2.1.4

12.3.2.1 DIMSE Service Group

12.3.2.1.1 N-CREATE

The N-CREATE DIMSE Service is used by LOGIQ P6 PRO to request that the SCP create a Film Box SOP Instance. Table 12.4.1-1 defines the Basic Film Box Presentation Module attributes used in this request.

12.3.2.1.2 N-ACTION

The N-ACTION DIMSE Service is used by LOGIQ P6 PRO to request the SCP (printer) to print the number of copies configured by the user to a film of the film session.

12.3.2.1.3 N-DELETE

The N-DELETE DIMSE Service is used by LOGIQ P6 PRO to request the SCP (printer) to delete the complete Film Box. The root Film Box Instance UID is sent to the SCP to accomplish this.

12.3.2.1.4 N-SET

Not used in this implementation.

12.3.3 Image Box SOP Class

12.3.3.1 Basic Grayscale Image Box SOP Class

The Basic Grayscale Image Box IOD is an abstraction of the presentation of an image and image related data in the image area of a film. The DIMSE services that are applicable to the IOD are shown in Table 12.4.3-1.

TABLE 12.3.3-1 DIMSE SERVICE GROUP

SOP Class Name	Usage SCU	Reference
N-SET	M	see 12.3.3.1.1

12.3.3.1.1 DIMSE Service Group (N-SET)

The N-SET DIMSE Service is used by LOGIQ P6 PRO to update the Basic Grayscale Image Box SOP Instance. Table 12.4.3-1 defines the Basic Image Box Presentation Module attributes used.

12.3.3.2 Basic Color Image Box SOP Class

The Basic Color Image Box IOD is an abstraction of the presentation of an image and image related data in the image area of a film. The DIMSE services that are applicable to the IOD are shown in Table 12.3.3-2.

TABLE 12.3.3-2 DIMSE SERVICE GROUP

SOP Class Name	Usage SCU	Reference
N-SET	M	see 12.3.3.2.1

12.3.3.2.1 DIMSE Service Group (N-SET)

The N-SET DIMSE Service is used by LOGIQ P6 PRO to update the Basic Color Image Box SOP Instance. Table 12.4.3-1 defines the Basic Image Box Presentation Module attributes used.

12.3.4 Printer SOP Class

The Printer IOD is an abstraction of the hard copy printer and is the basic Information Entity to monitor the status of the printer. The DIMSE services that are applicable to the IOD are shown in table 12.3.4-1.

12.3.4.1 DIMSE Service Group

TABLE 12.3.4-1 DIMSE SERVICE GROUP

SOP Class Name	Usage SCU	Reference
N-EVENT-REPORT	M	see 12.3.4.1.1
N-GET	U	see 12.3.4.1.2

12.3.4.1.1 N-EVENT_REPORT

LOGIQ P6 PRO confirms the N-EVENT-REPORT initiated by the SCP (printer).

12.3.4.1.2 N-GET

Used by LOGIQ P6 PRO to request the SCP to get a Printer SOP Instance. Table 12.4.4-1 defines the Printer Module attributes.

12.4 PRINT MANAGEMENT IODS

Within an entity of a DICOM Print Management, attributes are grouped into a related set of attributes. A set of related attributes is termed a module. A module facilitates the understanding of the semantics concerning the attributes and how the attributes are related with each other. A module grouping does not infer any encoding of information into datasets.

Table 12.4.1-1, Table 12.4.2-1, Table 12.4.3-1, and Table 12.4.4-1 identify the defined modules within the entities which comprise the DICOM Print Management Service IODs. Modules are identified by Module Name.

See DICOM for a complete definition of the entities, modules and attributes.

12.4.1 Film Session IOD Module

TABLE 12.4.1-1 FILM SESSION IOD MODULES

Module Name	Reference	Module Description
SOP Common Module	12.5.1.1	Contains SOP Common information
Basic Film Session Presentation Module	12.5.2.1	Contains Film Session presentation information
Basic Film Session Relationship Module	12.5.2.2	References to related SOPs

12.4.2 Basic Film Box IOD Module Table

TABLE 12.4.2-1 BASIC FIIM BOX IOD MODULES

Module Name	Reference
SOP Common Module	12.5.1.1
Basic Film Box Presentation Module	12.5.2.3
Basic Film Box Relationship Module	12.5.2.4

12.4.3 Basic Image Box IOD Module Table

TABLE 12.4.3-1 BASIC IMAGE BOX IOD MODULES

Module Name	Reference
SOP Common Module	12.5.1.1
Image Box Pixel Presentation Module	12.5.2.5

12.4.4 Printer IOD Module Table

TABLE 12.4.4-1 PRINTER IOD MODULES

Module Name	Reference
SOP Common Module	12.5.1.1
Printer Module	12.5.2.6

12.5 INFORMATION MODULE DEFINITIONS

Please refer to DICOM Standard Part 3 (Information Object Definitions) for a description of each of the entities and modules that comprise the Print Management.

The following modules are included to convey Enumerated Values, Defined Terms, and Optional Attributes supported.

12.5.1 General Modules

12.5.1.1 SOP Common Module

This section defines the attributes that are required for proper functioning and identification of the associated SOP Instances. They do not specify any semantics about the Real-World Object represented by the IOD.

TABLE 12.5.1-1 SOP COMMON MODULE ATTRIBUTES

Attribute Name	Tag	Type	Attribute Description
SOP Class UID	(0008,0016)	1	Varies with Module Instance and DIMSE Service being used. 1.2.840.100011.5.1.1.1 (Film Session) 1.2.840.100011.5.1.1.2 (Film Box) 1.2.840.100011.5.1.1.4 (Image Box)
SOP Instance UID	(0008,0018)	1	Provided by SCP (printer).
Specific Character Set	(0008,0005)	1C	Not used as expanded or replacement character sets not used.
Instance Creation Date	(0008,0012)	3	Not used.
Instance Creation Time	(0008,0013)	3	Not used.
Instance Creator UID	(0008,0014)	3	Not used.

12.5.2 Print Management Modules

For all user configurable tags with no default, no value will be sent if the tag is not configured.

12.5.2.1 Basic Film Session Presentation Module

This section defines the attributes that are common for all films of a film session. The attributes described in table 12.5.2-1 apply when the N-CREATE DIMSE service is used.

TABLE 12.5.2-1 BASIC FILM SESSION PRESENTATION MODULE ATTRIBUTES

Attribute Name	Tag	USAGE (SCU)	Attribute Description
Number of Copies	(2000,0010)	U	Defined Terms used (user configurable): Default is 1. Max is 99.
Print Priority	(2000,0020)	U	Defined Terms used (user configurable): HIGH, MED, LOW. Default is HIGH.
Medium Type	(2000,0030)	U	Defined Terms used (user configurable):

			PAPER BLUE FILM CLEAR FILM Default is CLEAR FILM.
Film Destination	(2000,0040)	U	Defined Terms used (user configurable): MAGAZINE - default PROCESSOR
Film Session Label	(2000,0050)	U	User configurable. No default.
Memory Allocation	(2000,0060)	U	Not Used

12.5.2.2 Basic Film Session Relationship Module

TABLE 12.5.2-2 BASIC FILM SESSION RELATIONSHIP MODULE ATTRIBUTES

Attribute Name	Tag	USAGE (SCU)	Attribute Description
Referenced Film Box Sequence	(2000,0500)	U	Not used
>Referenced SOP Class UID	(0008,1150)	U	
>Referenced SOP Instance UID	(0008,1155)	U	

12.5.2.3 Basic Film Box Presentation Module

The attributes described in table 12.5.2-3 apply when the N-CREATE DIMSE service is used.

TABLE 12.5.2-3 BASIC FILM BOX PRESENTATION MODULE ATTRIBUTES

Attribute Name	Tag	USAGE (SCU)	Attribute Description
Image Display Format	(2010,0010)	M	Enumerated values used (user configurable): STANDARD\X,Y, where X and Y can take values from 1 to 5. Default is STANDARD\1,1.
Annotation Display Format ID	(2010,0030)	U	Not used.
Film Orientation	(2010,0040)	U	Defined Terms used (user configurable): PORTRAIT - default LANDSCAPE
Film Size ID	(2000,0050)	U	Defined Terms used (user configurable): 8INX10IN - default 10INX12IN 10INX14IN 11INX14IN 14INX14IN 14INX17IN 24CMX24CM 24CMX30CM
Magnification Type	(2010,0060)	U	Defined Terms Used (user configurable): REPLICATE - default

Attribute Name	Tag	USAGE (SCU)	Attribute Description
			BILINEAR CUBIC NONE
Smoothing Type	(2010,0080)	U	Free form text entry field (user configurable) and only sent if Magnification Type is CUBIC. No default
Border Density	(2010,0100)	U	Defined Terms Used (user configurable): BLACK WHITE Default is BLACK.
Empty Image Density	(2010,0110)	U	Defined Terms Used (user configurable): BLACK WHITE Default is WHITE.
Min Density	(2010,0120)	U	User configurable. No default. Max is 999.
Max Density	(2010,0130)	U	User configurable. No default. Max is 999.
Trim	(2010,0140)	U	Enumerated Values Used (user configurable): YES NO Default is NO.
Configuration Information	(2010,0150)	U	User configurable. No default.

12.5.2.4 Basic Film Box Relationship Module

This section defines the attributes that describe the common parameters, which apply for all images on a given sheet of film

TABLE 12.5.2-4 BASIC FILM BOX RELATIONSHIP MODULE ATTRIBUTES

Attribute Name	Tag	USAGE (SCU)	Attribute Description
Referenced Film Session Sequence	(2010,0500)	M	
>Referenced SOP Class UID	(0008,1150)	M	1.2.840.10008.5.1.1.1
>Referenced SOP Instance UID	(0008,1155)	M	Provided by SCP (printer)
Referenced Image Box Sequence	(2010,0510)	U	
>Referenced SOP Class UID	(0008,1150)	U	1.2.840.10008.5.1.1.4.1
>Referenced SOP Instance UID	(0008,1155)	U	Provided by SCP (printer)
Referenced Basic Annotation Sequence	(2010,0520)	U	Not used
>Referenced SOP Class UID	(0008,1150)	U	
>Referenced SOP Instance UID	(0008,1155)	U	

12.5.2.5 Image Box Pixel Presentation Module

The attributes described in table 12.5.2-5 apply when the DIMSE Service N-SET is used.

The first attributes in the table are used for both grayscale and color printing. The attributes within the sequences are used for each type of printing respectively.

TABLE 12.5.2-5 IMAGE BOX PIXEL PRESENTATION MODULE ATTRIBUTES

Attribute Name	Tag	USAGE (SCU)	Attribute Description
Image Position	(2020,0010)	M	Based on the image display format.
Polarity	(2020,0020)	U	Defined term, NORMAL
Requested Image Size	(2020,0030)	U	Not sent
Basic Grayscale Image Sequence	(2020,0110)	M	only for Basic Grayscale printing.
>Samples Per Pixel	(0028,0002)	M	Value = '1'
>Photometric Interpretation	(0028,0004)	M	Defined Term MONOCHROME2 used
>Rows	(0028,0010)	M	Value depends on scanning mode and configuration setup.
>Columns	(0028,0011)	M	Value depends on scanning mode and configuration setup.
>Pixel Aspect Ratio	(0028,0034)	MC	Not used
>Bits Allocated	(0028,0100)	M	Value always = 0008H
>Bits Stored	(0028,0101)	M	Value always = 0008H
>High Bit	(0028,0102)	M	Value always = 0007H
>Pixel Representation	(0028,0103)	M	Defined Value '0' - unsigned integer
>Pixel Data	(7FE0,0010)	M	
Basic Color Image Sequence	(2020,0111)	M	only for Basic Color printing
>Samples Per Pixel	(0028,0002)	M	Value = '3'
>Photometric Interpretation	(0028,0004)	M	Defined Term RGB used
>Rows	(0028,0010)	M	Value depends on scanning mode and configuration setup.
>Columns	(0028,0011)	M	Value depends on scanning mode and configuration setup.
>Pixel Aspect Ratio	(0028,0034)	MC	Not used
>Bits Allocated	(0028,0100)	M	Value always = 0008H
>Bits Stored	(0028,0101)	M	Value always = 0008H
>High Bit	(0028,0102)	M	Value always = 0007H
>Pixel Representation	(0028,0103)	M	Defined Value '0' - unsigned integer
>Pixel Data	(7FE0,0010)	M	
>Planar Configuration	(0028, 0006)	M	0001H, color-by-plane, when Basic Color Image Sequence is set

12.5.2.6 Printer Module

This section defines the attributes that are used to monitor the status of the printer. The attributes described in Table 12.5.2-6 apply when the DIMSE Service N-GET is used.

TABLE 12.5.2-6 PRINTER MODULE ATTRIBUTES

Attribute Name	Tag	USAGE (SCU)	Attribute Description
Printer Status	(2110,0010)	U	Used to check the status of the printer before a print operation is started. Send the N-GET-RQ message for check the printer status and

Attribute Name	Tag	USAGE (SCU)	Attribute Description
			then response status message can get through the N-GET-RSP. If the status is different from Normal, Success the print operation is aborted, a message is displayed and the print files reside in the print buffer.
Printer Status Info	(2110,0020)	U	If return status is "FAILURE" an error message is displayed, and the print files resides in the print buffer. See Section PS3.3, C.13.9.1 for Defined Terms when the Printer Status is equal to WARNING or FAILURE.
Printer Name	(2110,0030)	U	Requested, but not used
Manufacturer	(0008,0070)	U	Requested, but not used
Manufacturer Model Name	(0008,1090)	U	Requested, but not used
Device Serial Number	(0018,1000)	U	Requested, but not used
Software Versions	(0018,1020)	U	Requested, but not used
Date Last Calibration	(0018,1200)	U	Requested, but not used
Last Calibration	(0018,1201)	U	Requested, but not used

13. STUDY ROOT QUERY/RETRIEVE INFORMATION MODEL DEFINITION

13.1 INTRODUCTION

This section specifies the use of the DICOM Study Root Query/Retrieve Model used to organize data and against which a Query/Retrieve will be performed. The contents of this section are:

13.2 - Information Model Description

13.3 - Information Model Entity-Relationship Model

13.4 - Information Model Keys

13.2 STUDY ROOT INFORMATION MODEL DESCRIPTION

This section defines the implementation of Study Root Query/Retrieve Information Model.

13.3 STUDY ROOT INFORMATION MODEL ENTITY-RELATIONSHIP MODEL

The Entity-Relationship diagram for the Study Root Information Model schema is shown in Illustration

13.3-1. In this figure, the following diagrammatic convention is established to represent the information organization:

- each entity is represented by a rectangular box
- each relationship is represented by a diamond shaped box.
- the fact that a relationship exists between two entities is depicted by lines connecting the corresponding entity boxes to the relationship boxes.

The relationships are fully defined with the maximum number of possible entities in the relationship shown. In other words, the relationship between Series and Image can have up to n Images per Series.

ILLUSTRATION 13.3-1
STUDY ROOT QUERY/RETRIEVE INFORMATION MODEL E/R DIAGRAM

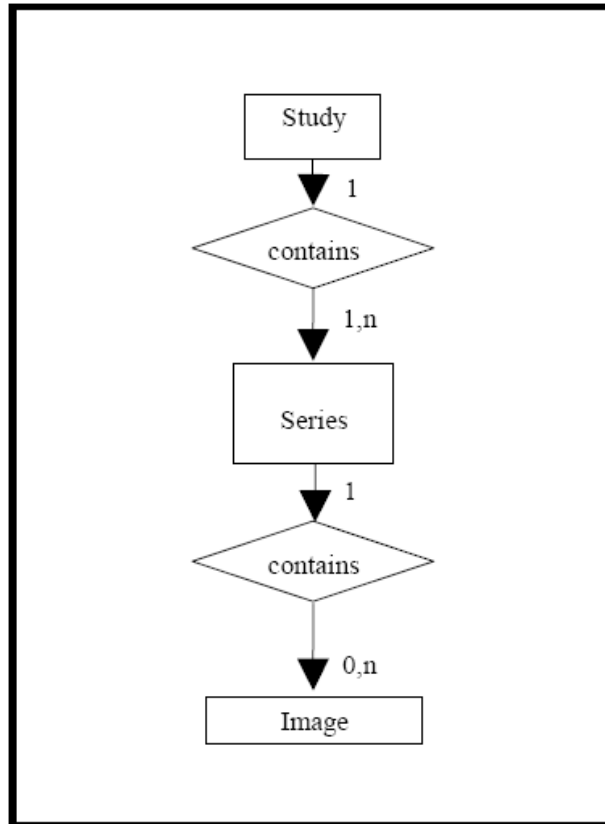

13.3.1 Entity Descriptions

Please refer to DICOM Standard PS 3.4 (Service Class Specifications) for a description of each of the levels contained within the Study Root Query/Retrieve Information Model.

13.3.2 LOGIQ P6 PRO Mapping of DICOM entities

TABLE 13.3-1
MAPPING OF DICOM ENTITIES TO LOGIQ P6 PRO ENTITIES

DICOM	LOGIQ P6 PRO Entity
Study	Exam
Series	Exam
Image	Image

13.4 INFORMATION MODEL KEYS

Please refer to DICOM Standard PS 3.4 (Service Class Specifications) for a description of each of the levels contained within the Study Root Query/Retrieve Information Model.

The following Level descriptions are included to specify what data elements are supported and what type of matching can be applied. It should be noted that they are the same ones as defined in the DICOM Standard PS 3.4 (Service Class Specifications).

13.4.1 Supported Matching

Following are the types of matching that can be request by the implementation:

- Single Value matching(S)
- Universal Matching(U)
- Wild Card Matching(*)
- Range of date, Range of Time(R)

The types of Matching supported by the C-FIND SCU are: ‘S’ indicates the identifier attribute uses Single Value Matching, an ‘R’ indicates Range Matching, a “*” indicates wildcard matching, a ‘U’ indicates Universal Matching, and ‘UNIQUE’ indicates that this is the Unique Key for that query level, in which case Universal Matching or Single Value Matching is used depending on the query level.

Fields with “Filtering is supported” in the Matching column can be controlled from the Search screen. This means that the user can filter the downloaded C-FIND result, to view a limited set of the result.

All non-required matching fields can be configured in Config screen to be either enabled, enabled with a constant value or disabled. The constant value will be used as entered by user.

13.4.2 Study Level

This section defines the keys at the Study Level of the Study Root Query/Retrieve Information Model that are supported by this implementation.

**TABLE 13.4-2
STUDY LEVEL ATTRIBUTES FOR THE STUDY ROOT
QUERY/RETRIEVE INFORMATION MODEL**

Attribute Name	Tag	Type of Matching
Study Date	(0008,0020)	R - Filtering is supported.
Study Time	(0008,0030)	R
Accession Number	(0008,0050)	*, S, U - Filtering is supported.
Patient's Name	(0010,0010)	*, U - Filtering is supported.
Patient ID	(0010,0020)	*, U - Filtering is supported.
Study ID	(0020,0010)	S,*, U - Filtering is supported.
Study Instance UID	(0020,000D)	UNIQUE
Modalities in Study	(0008,0061)	S,*, U
Referring Physician's Name	(0008,0090)	S,*, U
Study Description	(0008,1030)	S,*, U - Filtering is supported.
Procedure Code Sequence	(0008,1032)	U
>Include 'Code Sequence Macro'		U
Name of Physician(s) Reading Study	(0008,1060)	U
Admitting Diagnoses Description	(0008,1080)	U
Referenced Study Sequence	(0008,1110)	U
>Referenced SOP Class UID	(0008,1150)	U
>Referenced SOP Instance UID	(0008,1155)	U
Referenced Patient Sequence	(0008,1120)	U
>Referenced SOP Class UID	(0008,1150)	U
>Referenced SOP Instance UID	(0008,1155)	U
Patient's Birth Date	(0010,0030)	R - Filtering is supported.
Patient's Birth Time	(0010,0032)	R
Patient's Sex	(0010,0040)	S,U - Filtering is supported.
Other Patient IDs	(0010,1000)	U

Attribute Name	Tag	Type of Matching
Other Patient Names	(0010,1001)	U
Patient's Age	(0010,1010)	U
Patient's Size	(0010,1020)	U
Patient's Weight	(0010,1030)	U
Ethnic Group	(0010,2160)	U
Occupation	(0010,2180)	U
Additional Patient History	(0010,21B0)	U
Patient Comments	(0010,4000)	U
Other Study Numbers	(0020,1070)	U
Number of Patient Related Studies	(0020,1200)	U
Number of Patient Related Series	(0020,1202)	U
Number of Patient Related Instances	(0020,1204)	U
Number of Study Related Series	(0020,1206)	U
Number of Study Related Instances	(0020,1208)	U
Interpretation Author	(4008,010C)	U

TABLE 13.4-3
Q/R STUDY LEVEL AND LOCATION FOR RETRIEVE ATTRIBUTES

Attribute Name	Tag	Note
Query Retrieve Level	(0008,0052)	Value = STUDY

TABLE 13.4-4
Q/R SPECIFIC CHARACTER SET ATTRIBUTES

Attribute Name	Tag	Note
Specific Character Set	(0008,0005)	Set to "ISO_IR 100" if extended characters are used in query. ISO_IR 100 is supported in responses.

13.4.3 Series Level

This section defines the keys at the Series Level of the Study Root Query/Retrieve Information Model that are supported by this implementation.

TABLE 13.4-5
SERIES LEVEL ATTRIBUTES FOR THE STUDY ROOT
QUERY/RETRIEVE INFORMATION MODEL

Attribute Name	Tag	Type of Matching
Modality	(0008,0060)	U
Series Number	(0020,0011)	U
Series Instance UID	(0020,000E)	UNIQUE
Number of Series Related Instances	(0020,1209)	U
Series Date	(0008,0021)	R
Series Time	(0008,0031)	R
Performing Physicians' Name	(0008,1050)	U
Protocol Name	(0018,1030)	U
Series Description	(0008,103E)	

Attribute Name	Tag	Type of Matching
Operator's Name	(0008,1070)	U
Institutional Department Name	(0008,1040)	U
Software Versions	(0018,1020)	U
Performed Procedure Step Start Date	(0040,0244)	R
Performed Procedure Step Start Time	(0040,0245)	R

TABLE 13.4-6
Q/R SERIES LEVEL AND LOCATION FOR RETRIEVE ATTRIBUTES

Attribute Name	Tag	Note
Query Retrieve Level	(0008,0052)	Value = SERIES

TABLE 13.4-7
Q/R SPECIFIC CHARACTER SET ATTRIBUTES

Attribute Name	Tag	Note
Specific Character Set	(0008,0005)	Set to "ISO_IR 100" if extended characters are used in query. ISO_IR 100 is supported in responses.

13.4.4 Image Level

This section defines the keys at the Image Level of the Study Root Query/Retrieve Information Model that are supported by this implementation.

TABLE 13.4-8
IMAGE LEVEL ATTRIBUTES FOR THE STUDY ROOT
QUERY/RETRIEVE INFORMATION MODEL

Attribute Name	Tag	Attribute Description
Instance Number	(0020,0013)	U
SOP Instance UID	(0008,0018)	UNIQUE
Contrast/Bolus Agent	(0018,0010)	U

TABLE 13.4-9
Q/R IMAGE LEVEL AND LOCATION FOR RETRIEVE ATTRIBUTES

Attribute Name	Tag	Note
Query Retrieve Level	(0008,0052)	Value = IMAGE

TABLE 13.4-10
Q/R SPECIFIC CHARACTER SET ATTRIBUTES

Attribute Name	Tag	Note
Specific Character Set	(0008,0005)	Set to "ISO_IR 100" if extended characters are used in query. ISO_IR 100 is supported in responses.

13.5 PRIVATE DATA DICTIONARY

No private data dictionary is defined.